

~~SECRET~~ LEVEL II

2

# NOSC

NOSC TR 422

DECLASSIFIED UNDER AUTHORITY OF THE  
INTERAGENCY SECURITY CLASSIFICATION APPEALS PANEL,  
E.O. 13526, SECTION 5.3(b)(3)

ISCAP APPEAL NO. 2006-033, document no. 1  
DECLASSIFICATION DATE: December 02, 2016

NOSC TR 422

AD C02234b

Technical Report 422

## PROJECT COMBO: REVIEW AND RECOMMENDATIONS (U)

WC Cummings, RL Seeley,  
PO Thompson, RA Johnson

July 1980

Prepared for:  
Naval Sea Systems Command  
and  
Naval Electronic Systems Command

\*NATIONAL SECURITY INFORMATION\*

\*Unauthorized Disclosure Subject to Criminal  
Sanctions\*

Classified by: OPNAVINST S 5513.5-39  
Review on: 16 September 1997

DTIC  
ELECTE  
S AUG 28 1980 D

DDG FILE COPY

NAVAL OCEAN SYSTEMS CENTER  
SAN DIEGO, CALIFORNIA 92152

Copy 24 of 50 Copies  
S-5029-79

~~SECRET~~

Document No. H-00106-80

80 8 25 517

**Best  
Available  
Copy**

~~SECRET~~

(This page is unclassified)



NAVAL OCEAN SYSTEMS CENTER, SAN DIEGO, CA 92152

AN ACTIVITY OF THE NAVAL MATERIAL COMMAND

SL GUILLE, CAPT, USN

Commander

HL BLOOD

Technical Director

ADMINISTRATIVE INFORMATION (U)

(U) This work was performed under sponsorship of Naval Sea Systems Command and Naval Electronic Systems Command.

(U) We acknowledge the assistance of J. F. Fish and R. S. Gales of NOSC throughout Project COMBO. We are grateful for the help of M. E. Dahlheim, A. Dibelka, D. Ferrin, J. D. Finch, M. D. Flaska, S. J. Kennison, LT M. Marich USN, D. E. Marsh, J. L. Stewart and E. Wrench at NOSC, for the support of D. G. Hoffman and C. D. Smith at NAVSEA and M. L. Parker, Jr. and I. L. Smietan at NAVELIX, and for the assistance of H. B. Stone in OP 987 and CDR D. R. Moyer USN, CDR G. B. Lowe USN and LCDR A. J. Dietzler USN at NMAT 03.

(U) J. F. Fish and G. A. Turton were the technical reviewers. W. A. Friedl assisted with technical editing and final report organization.

Released by  
JM STALLARD, Head  
Bioacoustics & Bionics Division

Under authority of  
HO PORTER, Head  
Biosciences Department

~~SECRET~~

(This page is unclassified)

**SECRET**

(This page is **CONFIDENTIAL**)

SECURITY CLASSIFICATION OF THIS PAGE (When Data Entered)

REPORT DOCUMENTATION PAGE		READ INSTRUCTIONS BEFORE COMPLETING FORM
1. REPORT NUMBER NOSC/TR-422 ✓	2. GOVT ACCESSION NO. AD-C022 345	3. RECIPIENT'S CATALOG NUMBER
4. TITLE (and Subtitle) PROJECT COMBO: REVIEW AND RECOMMENDATIONS (U) (7)		5. TYPE OF REPORT & PERIOD COVERED Final July 71 - Sep 78
7. AUTHOR(s) WC CUMMINGS, RL SEELEY, PO THOMPSON, RA JOHNSON		6. PERFORMING ORG. REPORT NUMBER
9. PERFORMING ORGANIZATION NAME AND ADDRESS Naval Ocean Systems Center, Hawaii Laboratory P. O. Box 997 Kailua, Hawaii 96734		8. CONTRACT OR GRANT NUMBER(s) F-12-13 F-100-17
11. CONTROLLING OFFICE NAME AND ADDRESS Naval Sea Systems Command (NSEA 63R33) Department of the Navy Washington, D. C. 20362		10. PROGRAM ELEMENT, PROJECT, TASK AREA & WORK UNIT NUMBER 62721N: F21221 (SF21281071) XF21222701 NSEA06H1-31, NELEX 310
14. MONITORING AGENCY NAME & ADDRESS (if different from Controlling Office)		12. REPORT DATE July 1980
16. DISTRIBUTION STATEMENT (of this Report)		13. NUMBER OF PAGES 44
17. DISTRIBUTION STATEMENT (of the abstract entered in Block 20, if different from Report)		15. SECURITY CLASS. (of this report) <del>SECRET</del>
18. SUPPLEMENTARY NOTES		16a. DECLASSIFICATION/DOWNGRADING SCHEDULE 16 SEPT 1997 Review on
19. KEY WORDS (Continue on reverse side if necessary and identify by block number)		
Bandwidth	Large Whales	Pinnipeds
Bioacoustics	Low-Data Rate	Signal-to-noise Ratio
Communications	Marine Mammals	Signal Synthesis
Covert	Measure Format	Small Whales
IACS	Pilot Whale	Sonogram
		Source Levels
		Submarine
		Transducers
		Waterfall Display
		Whistles
20. ABSTRACT (Continue on reverse side if necessary and identify by block number)		
<p>(C) Project COMBO produced the elements of a covert communications system that conveys coded messages using selected marine animal sounds in a natural sound environment. Project progress includes development of a coding technique, a computer program for elemental synthesis, and a recognizer/decoder instrument that is compatible with fleet low-data-rate communications equipment. The report also discusses properties of available transducers and characteristics of marine animal sounds as possible elements of covert communication systems.</p>		

DD FORM 1 JAN 73 1473

EDITION OF 1 NOV 65 IS OBSOLETE (This page is **CONFIDENTIAL**)

SECURITY CLASSIFICATION OF THIS PAGE (When Data Entered)

**SECRET**

393159

48

~~CONFIDENTIAL~~

SECURITY CLASSIFICATION OF THIS PAGE (When Data Entered)

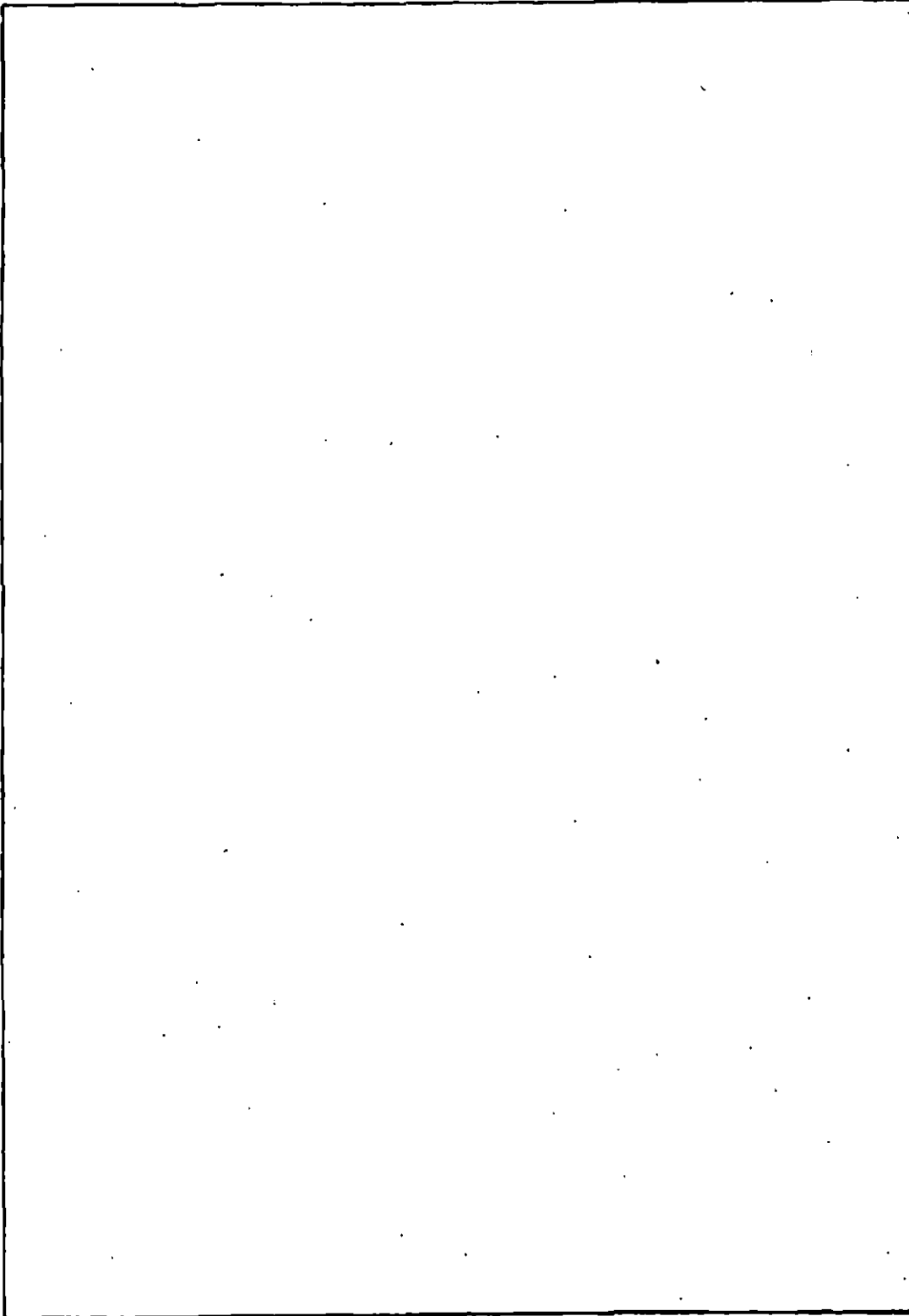

~~CONFIDENTIAL~~

SECURITY CLASSIFICATION OF THIS PAGE(When Data Entered)

~~SECRET~~

**FOREWORD (U)**

~~(S)~~ Project COMBO\* uses coded marine animal sounds for a covert underwater communications system with ranges to 50 nmi. The Project COMBO concept originated in 1959 at the Navy Electronics Laboratory. Collection and analysis of sounds suitable for ultimate use in Project COMBO began in 1965. We recorded marine animal sounds, measured sound source levels, observed animal behavior and initiated acoustic analyses. In 1970, the Defense Advanced Research Projects Agency (DARPA) sponsored analysis and duplication of sonogram patterns of marine mammal sounds we had collected and the Naval Ship Systems Command (NAVSHIPS) sponsored the Project COMBO communications application of the sounds.

~~(S)~~ During Project COMBO, we developed a coding technique that uses temporal and frequency patterns to convey messages. We also developed a recognizer/decoder instrument, the COMBO Signal Recognizer (CSR), and produced the improved CSR-II from it. We developed methods for computer sound synthesis and investigated communications applications of entire sound sequences. Laboratory and sea tests used six demonstration messages based on coded pilot whale sounds; messages were received correctly underwater out to 50 nmi.

~~(S)~~ The Project COMBO effort was coordinated with the Low Data Rate, Quick Response Program of the Integrated Acoustic Communications System plan. In this report we review Project COMBO and relate the project concept to advanced development and fleet use. We present background information and discuss the Project COMBO plan.

Accession For	
NTIS GRA&I	<input checked="" type="checkbox"/>
DDC TAB	
Unannounced	
Justification _____	
By _____	
Distribution/ _____	
Availability Codes	
Dist..	Avail and/or special
9	

\* (U) COMBO is not an acronym

DTIC  
ELECTE  
S AUG 29 1980 D  
D

~~SECRET~~

~~SECRET~~

## SUMMARY (U)

### OBJECTIVE (U)

~~(S)~~ Develop a covert communications system with a bioacoustical message format using animal sounds as message elements that are recognizable with existing fleet signal processing equipment.

### RESULTS (U)

1. ~~(S)~~ A coding technique, a computer program for elemental sound synthesis and a recognizer/decoder instrument that is compatible with fleet low-data-rate communications equipment were developed.
2. ~~(S)~~ Pilot whale sounds were synthesized and coded to convey six demonstration messages. Messages were received correctly underwater out to 50 nmi.

### RECOMMENDATIONS (U)

1. ~~(S)~~ Coordinate progress and results from Project COMBO into the Integrated Acoustic Communication System Plan, especially the Low Data Rate/Quick Response Program.
2. ~~(S)~~ Develop techniques and equipment to synthesize large whale sounds and small whale screams and to process wideband clicks and frequency-swept signals.
3. ~~(S)~~ Modify the COMBO signal receiver system to utilize more message frequencies. Increase the CSR processing bit rate to 0.07 bits/sec. Use automatic gain control and a wider filter pass band on the receiver system. Adapt parallel coding/decoding to the CSR; update the input pattern every 50 msec.
4. ~~(S)~~ Perform an error analysis on the triple-redundant message format.
5. ~~(S)~~ Develop and maintain a reference collection of recorded marine animal sounds. Collect information on the distribution and habits of bioacoustic source animals.

~~SECRET~~

~~SECRET~~

CONTENTS (U)

INTRODUCTION ... page 7

BACKGROUND ... 8

    CONCEPT ... 8

    AUTHENTICITY ... 8

    UTILITY ... 8

PROGRESS ... 8

    HARDWARE CONFIGURATION ... 8

    SIGNAL SECURITY ... 9

    ENVIRONMENTAL FACTORS ... 10

    SYSTEM COMPONENTS ... 10

SIGNALS ... 10

    LARGE WHALES ... 11

    SMALL WHALES ... 13

    PINNIPEDS ... 15

SIGNAL DETECTION ... 16

    OPERATING FEATURES ... 16

    SEA TESTS ... 19

    RECOMMENDATIONS FOR DEVELOPMENT ... 25

SIGNAL SYNTHESIS ... 25

    ANALYSIS OF MARINE MAMMAL SOUNDS ... 25

    TECHNIQUE OF COMPUTER SYNTHESIS ... 26

        Marine Mammal "Screams" ... 26

TRANSDUCERS ... 31

    BACKGROUND ... 31

    FLEET PROJECTORS ... 31

    OTHER PROJECTORS ... 32

    LOW-FREQUENCY PROJECTORS ... 37

    FLEET RECEIVING TRANSDUCERS ... 37

~~SECRET~~



~~SECRET~~

DEPLOYMENT SECURITY . . . 37

    TRANSDUCERS . . . 37

    SOURCE LEVELS . . . 37

    SIGNAL SYNTHESIS . . . 39

    SIGNAL OCCURRENCE . . . 40

FLEET IMPACT . . . 40

REFERENCES . . . 41

RELATED DOCUMENTS . . . 44

#### ILLUSTRATIONS (U)

1. COMBO system concept . . . page 7
2. Sonograms of sound with COMBO applications . . . 12
3. COMBO Signal Recognizer, CSR-II, elements and configuration . . . 16
4. Sonogram of natural pilot whale sounds used in Project COMBO . . . 17
5. Received level of COMBO signals measured in CSR-I tests . . . 22
6. Time-frequency waterfall plot of a simulated killer whale sound . . . 27
7. Time-frequency waterfall plot of a natural killer whale sound . . . 28
8. Waterfall display of computer-synthesized, pilot whale sinusoidal whistles . . . 29
9. Expanded waterfall display of the middle set of computer-synthesized whistles . . . 30
10. Sonograms of blue whale sounds re-recorded directly from the playback tape recorder . . . 34
11. Waterfall displays of killer whale spectra . . . 35
12. Response of IIX-182A projector in series with a 110-to-200 Hz band rejection filter . . . 36

~~SECRET~~

~~SECRET~~

TABLES (U)

1. Signal-to-noise ratios (dB) from Project COMBO transmission tests; September 1973 . . . 21
2. Signal-to-noise summary, April 1975 . . . 23
3. Received signal-to-noise ratios/Hz, in dB . . . 24
4. Fleet sonars considered for COMBO-like applications . . . 33
5. Non-fleet projectors considered for COMBO-like applications . . . 33
6. Low-frequency projectors surveyed for possible COMBO-like applications . . . 38
7. Fleet receivers suitable for possible COMBO-like applications . . . 39

~~SECRET~~

~~SECRET~~

### INTRODUCTION (U)

~~(S)~~ Project COMBO was a four-year research and development effort to produce a covert-by-disguise underwater communications system using coded underwater sounds of marine animals. The coded sounds are generated at one platform and received and decoded at another (figure 1). Marine animal sounds are common and prominent components of the natural underwater sonic environment. Military communications based on natural animal sounds confound detection by even informed enemy surveillance because the messages are but a small portion of the total biological chorus. As part of Project COMBO we characterized marine animal sounds, devised a distortion-free coding scheme, identified signal processing techniques, developed a method to project, detect and decode signals, and synthesized sounds with computer algorithms. Project development can be traced in references 1-4.

### COMBO RECEIVER

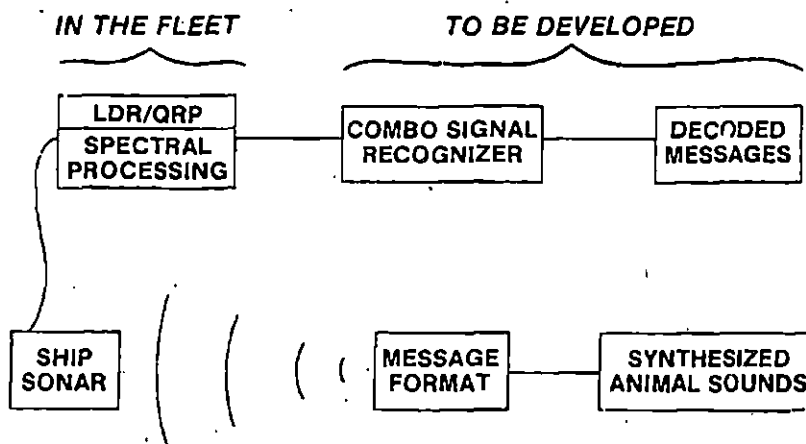

~~(CONFIDENTIAL)~~

(U) Figure 1. COMBO system concept.

~~(S)~~ Project COMBO relates to the Integrated Acoustic Communications System (IACS) Plan (reference 5), especially the Low Data Rate, Quick Response Program (LDR/QRP) (reference 6). The project provides a system for submarines to communicate LDR messages up to a 50 nmi range without revealing their location. Such LDR messages may be useful in Identification Friend or Foe (IFF) functions, during escort or to coordinate support, trail, barrier or fire control activities. The system also provides submarines a covert means to transmit sweep finds to surface units and to contact other submarines prior to conventional communication. Use of natural underwater sounds makes the COMBO system a relatively covert solution to LDR communication tasks.

~~SECRET~~

~~SECRET~~

## BACKGROUND (U)

### CONCEPT (U)

~~IS~~ The project's objective is to develop a covert communications system with a bioacoustic message format using animal sounds as message elements. Messages can be received with existing signal processing equipment in the fleet. The system will confound interceptors by presenting an overwhelming task of analyzing all marine mammal sounds encountered in order to identify possible message elements.

### AUTHENTICITY (U)

~~IS~~ Fidelity of transmitted sounds depends on signal-to-noise ratio and transmission bandwidth. Sounds recorded for communications applications must have a high signal-to-noise ratio or undergo subsequent noise removal. Transmitters must maintain sufficient bandwidth to preserve the sounds' natural qualities.

(U) Improved fidelity factors result from better recording techniques, improved signal processing and synthesis and advanced transducer development.

~~IS~~ The transmissions' temporal and geographic consistency depends on detailed knowledge of distribution and habits of bioacoustic source animals.

### UTILITY (U)

~~IS~~ The COMBO communication system utilizes receiving and processing equipment, such as the WQC-5, already in fleet use. System implementation requires message recognition equipment, transducer optimization and signal generation capability. Tape recordings or real time signal-synthesizing computers can generate the signals.

## PROGRESS (U)

### HARDWARE CONFIGURATION (U)

(U) The configuration of the Project COMBO equipment is described in this section.

~~IS~~ The waveform generator is a magnetic tape recorder that plays cassettes containing coded analog recordings of pilot whale phonations in natural choruses.

(U) A specially-designed 1-kW amplifier drives selectable-impedance transducers at full power in the frequency band from 20 Hz to 10 kHz.

~~IS~~ Acoustic sources included a free-flooded cylindrical transducer to reproduce pilot whale sounds. Critical characteristics of the transducer were broadband response, high

~~SECRET~~

~~SECRET~~

power capacity, depth insensitivity, small size and light weight. Parametric transducers were also used in test pools and at sea in cooperation with personnel from the Naval Underwater Systems Center.

~~487~~ Channels up to 50 nmi long were established during sea tests. Coded pilot whale sounds in the 1.5- to 4.0-kHz band were projected at levels up to 200 dB re  $\mu\text{Pa}$  at 1 m. Projector and receiver depths varied from near surface to 122 m. The water column was well-mixed.

~~487~~ Acoustic sensors are cable-connected, calibrated hydrophones or military sonobuoys. Modified shot buoys provide an ejectable transceiver to extend the surface or airborne communication range without increased transmitted acoustic power.

~~487~~ The coding employs frequency shift keying (FSK) using natural tones inherent in the signals within a chorus of animal sounds. Triple-redundant transmission is used to overcome interference. A message is repeated three times in three different ways in a 90-second interval. The message format is deterministic and provides a choice from six different messages with assigned meaning.

~~487~~ The message detector is the modified COMBO Signal Recognizer, CSR-II. The CSR-II has an operator-set threshold calibration, error-correcting logic and external circuit testers. The instrument shifts automatically to account for missing up to two of the three signals in the first signal set. The CSR-II also accounts for missing signals and for random signal occurrence within a specific time interval. The instrument recognizes multiple qualifying signals preceding messages and extracts the messages from the transmissions.

~~487~~ The signal band is not limited in this plan. Analog voltages input to the CSR-II may represent any preprocessing algorithm and thus do not confine the encoding-decoding method to tonal preprocessing. The decoding scheme accommodates broadband animal sounds with rapid FM sweeps and rich harmonic structure. The CSR-II uses standard spectral processing instruments related to the AN/BQR-20/22/23 equipment and to the WQC-5 (LDR/QRP) communication system (reference 6).

#### SIGNAL SECURITY (U)

~~487~~ Covert use of the COMBO communication scheme requires computer synthesis of animal sounds. Marine animal signals recorded in nature are inseparably imbued with noise and cannot be used directly as a signal waveform. Non-uniform spatial distributions in the noise field projected with natural animal sounds would destroy the communications' covertness. The code format requires a unique, ever-changing sequence of background sounds to maintain the code's natural quality. In the COMBO scheme, all sounds would be synthesized.

~~487~~ The COMBO plan provides six possible messages which can be assigned arbitrary meaning that can be changed at any time. A "code of the day" is possible with the plan. The number of messages can be increased by using different equipment configurations and other signal processing techniques. The CSR-II bit rate is about 0.035 bits/sec and can be doubled to 0.07 bits/sec by using sweep limit control (reference 7).

~~SECRET~~

~~SECRET~~

~~(S)~~ Transducers and amplifiers used in the COMBO scheme must be compatible with fleet equipment. We surveyed transducers in fleet use and other low-frequency transducers that could be used in the COMBO system (reference 8, 9). With minor modifications, fleet transducers are marginally acceptable for COMBO transmissions in certain frequency bands. For example, the UQC-2 transducer is the best fleet transducer for pilot whale sounds. The fleet transducers surveyed have limited low-frequency capability. The extended low-frequency response of the other transducers surveyed would enable transmission of more diverse signals over greater ranges.

#### ENVIRONMENTAL FACTORS (U)

~~(S)~~ Covertness of COMBO communication depends upon signal fidelity and the naturalness of the animal sounds. The sounds' physical characteristics, such as source level and tonal components, must be proper. Preferred sounds are from marine mammals, such as pilot whales or killer whales, with a cosmopolitan occurrence. The sounds must be used in an appropriate context. For instance, mating signals transmitted in a non-mating season could arouse the suspicion of a knowledgeable monitor. The sounds from a single species may vary regionally. Thus, well-known dialects should not be used out of context. These speculations presume a knowledgeable interceptor.

~~(S)~~ The COMBO plan requires natural sounds to provide a "cover" for communication signals. In some areas certain species of whales have become scarce through overharvesting, but conservation measures have allowed other populations to increase. For example, the southern right whale is nearly extinct but the grey whale population is increasing. Population size is not necessarily directly related to acoustic presence. For example, the humpback whale population is small but the species is particularly soniferous. Similarly, the killer whale (*Orcinus orca*), is frequently heard even though its population is depleted. Thus, the use of COMBO sounds in the ocean requires relatively few whales, and conservation measures should guarantee populations at least as large as present ones.

#### SYSTEM COMPONENTS (U)

(U) The following sections present six aspects of the COMBO system: Signals, Signal Detection (CSR), Signal Synthesis, Transducers, Deployment Security, and Fleet Impact.

#### SIGNALS (U)

~~(S)~~ Three categories of marine mammals produce sounds with potential COMBO application: large whales, small whales (including porpoises), and pinnipeds (seals and sea lions). The listed sounds are common and contain tonal components. Within the whale categories, animals are discussed in order of probable potential applicability to the COMBO communications scheme from most to least likely. Pinnipeds are not so ordered, because most occur in non-overlapping geographical areas, and nearly all are very vocal.

~~SECRET~~

~~SECRET~~

~~ET~~ Large whales produce low-frequency sounds with high source levels. The low-frequency sounds require special transducers. The sounds could be used in a COMBO communications scheme with an intended range beyond 50 nmi or for shorter distances under very noisy conditions. Sounds from small whales and from pinnipeds are higher in frequency and therefore easier to reproduce with transducers. In a COMBO communications scheme, sounds from small whales and pinnipeds are limited to ranges below 50 nmi unless source levels are at least 20 dB over natural. The most suitable large whale sounds for COMBO are from humpback, right, and finback and from pilot, killer and beluga among the small whales (see figure 2).

#### LARGE WHALES (U)

(U) The humpback whale, *Megaptera novaeangliae*, produces a variety of underwater calls including howls, moans, grunts, cries, yelps, and low-frequency pulses. Fundamental components cover frequencies from 20 to 2000 Hz, with harmonics as high as 5000 Hz. Sound duration varies from 0.2 sec to over 5 sec, and source level may exceed 180 dB re 1  $\mu$ Pa. Humpback whale phonations are often frequency modulated.

(U) When not migrating, humpback whales occur coastally and are distributed in all oceans. The whales occur in lower latitudes during winter and spring and in higher latitudes, including polar seas, during summer. In the breeding areas around Bermuda, the West Indies, Hawaii, and New Zealand, humpback whale sounds are grouped into "songs" that last up to 30 min, contain sections of repetitive, stereotyped phrases, and may be repeated for hours (reference 10).

(U) The right whale, *Eubalaena glacialis*, produces sounds similar to humpback whale sounds: moans, grunts, and bellows intermingled with pulses and rasping sounds (reference 11). Line components vary between 50 and 1500 Hz, with durations from 0.2 to at least 4 sec. Most of the energy in the phonations occurs below 500 Hz. Sound source level is over 180 dB re 1  $\mu$ Pa. Right whales are widely distributed in small numbers, in coastal waters, in latitudes poleward of 25 degrees. Right whales migrate to lower latitudes during the winter.

(U) The finback whale, *Balaenoptera physalus*, produces pulses and moans in the range from 16 to 100 Hz, with less than 1 sec duration. Sonic finback whale sounds are frequency modulated (references 12, 13). Finback whales produce pulse trains centered at 20 Hz, with regular inter-pulse intervals of a few seconds (reference 14). The 20-Hz pulses occur in doublets with intra- and inter-doublet intervals of 10 to 25 sec. The pulse trains continue for hours, and constitute well-known interferences at SOSUS stations. Another finback whale sound is a 3-sec moan composed of a 68-Hz, 1.8-sec component followed by a 34-Hz component varying in length up to 1.8 sec. Source levels of finback whale sounds range up to 180 dB re 1  $\mu$ Pa (reference 13). The finback whale occurs in all oceans, especially in polar seas during summer months.

~~ET~~ Off Chile, the blue whale, *Balaenoptera musculus*, produces 37-sec sequences of three moans. The interval between the first two moans varies up to 2 sec, and between the second and third from 1.5 to 3.5 sec. A 390-Hz tonal pulse occurs just before the last moan.

~~SECRET~~



(S) Figure 2. Sonograms of sound with COMBO applications. A. beluga. B. killer whale. C. pilot whale. D. clicks of each, respectively. Effective analyzing filter bandwidth, 20 Hz (A,B,C.) 800 Hz (D).



~~SECRET~~

The blue whale moans average 188-dB source level, and are amplitude-modulated at 3.9 and 7.8/sec. The strongest components occur at 26 Hz, and others extend to about 200 Hz. Sequences typically repeat every 1.7 min, but the silent interval may be as long as 3.3 min (reference 15). In the eastern North Pacific, blue whales produce similar moans of two types, with the most energy near 20 Hz. Blue whales occur in all oceans. They concentrate at high latitudes during summer months and off California in autumn. The long, 20-Hz phonations are well-known at SOSUS stations from southern California to the Bering Sea (reference 12).

~~(S)~~ The sperm whale, *Physeter catodon*, produces trains of short clicks. At slow repetition rates, the sperm whale click trains are called "carpenter fish" sounds by Navy sonar-men. The clicks have a source level as high as 175 dB and most energy between 200 and 10,000 Hz. The click repetition rate ranges from 1 to 100 per second. Short click trains may have distinct rhythmic patterns, and may be repeated (references 16, 17). Sperm whales are usually found in groups that produce clicks in chorus. The sperm whale is distributed in all oceans, especially in tropical and sub-tropical waters near the Azores, Peru, the Galapagos, and off Central California. Because of their ubiquity, high source level and common occurrence, sperm whale sounds are familiar to sonar-men of all nationalities and are excellent sounds for COMBO application.

~~(S)~~ The click structure of sperm whale signals is incompatible with present COMBO methods of narrow frequency band processing and coding and requires instead, wideband threshold detection and simple temporal coding patterns. Nevertheless, sperm whale sounds are ideal for biological communication applications.

#### SMALL WHALES (U)

~~(S)~~ The pilot whale, *Globicephala melano*, *G. scammoni*, and *G. macrorhyncha* produces a variety of sounds, including clicks, whistles, squeals, warbles, and grunts (references 18, 19 and 20). Some pilot whale whistles are pure-tone, and others are rich in harmonics. A whistle may remain at a single frequency for up to a second, or sweep over several kHz in the same time. Whistle and squeal energy is distributed from 500 Hz to 15 kHz at a source level of at least 175 dB. A large proportion of whistles and squeals are below 8 kHz. Except for polar seas, pilot whales occur in every large body of marine water. Pilot whale sounds are suitable for COMBO transmissions of 25 to 50 nmi.

(U) In the eastern North Pacific, killer whales, *Orcinus orca*, emit narrowband clicks of 10 to 25 msec duration (reference 21). The fundamental resonant click frequency is in the 250- to 500-Hz range. The clicks occur in short bursts of 10 to 15, or in much longer, high-repetition-rate, raucous screams. Screams occur in two parts, one at a repetition rate about 0.5 kHz, and the other at about 2 kHz. Both scream parts have many harmonics. In Antarctic waters, killer whales emit click trains similar to those of northern animals (reference 22). Antarctic killer whales do not produce the stereotyped screams characteristic of their northern counterparts. Killer whales occur worldwide, especially near coasts at higher latitudes and in polar regions.

~~SECRET~~

~~SECRET~~

(U) Belugas, *Delphinapterus leucas*, may be the most soniferous sea mammals (reference 23). Belugas emit a variety of sounds, including whistles, warbles, chirps, clicks, buzzes, cries and moans at frequencies up to 400 kHz. Beluga sounds typically contain energy in narrow frequency bands. Belugas occur mainly in the Arctic Ocean. The whales occur seasonally as far south as 50°N, and are abundant in the Davis Straits, Hudson Bay, Gulf of St. Lawrence, and along the coasts of Alaska, Norway, and the Soviet Union. Belugas do not occur in the southern hemisphere.

(U) False killer whales, *Pseudorca crassidens*, produce whistles in the 2.5- to 5-kHz frequency band, with some energy up to 8 kHz. False killer whales also emit clicks and buzzes (reference 20). Except in polar regions, false killer whales occur in open seas throughout the world.

(U) The bottlenose porpoise, *Tursiops truncatus*, clicks at frequencies up to 200 kHz and whistles in narrow bands between 4 and 15 kHz (reference 24). Bottlenose porpoise click trains can sound like barks, yelps, squeaks, squawks, or rusty gates. The bottlenose porpoise occurs widely in the Atlantic and Indian Oceans and is common along the coasts of the Americas and Europe. Related species (*T. gilli* and *T. minor*) occur in warmer parts of the Pacific, particularly in the China Sea and in coastal American waters.

(U) Atlantic spotted porpoises, *Stenella plagiodon*, produce broadband clicks and whistles in the 5- to 15-kHz frequency range (reference 20). The spotted porpoise occurs along the Atlantic coasts of Europe and America, and in the Indian Ocean. A related species, *Stenella graffmani*, also called "spotted dolphin", occurs in the eastern tropical Pacific.

(U) Pacific white-sided porpoises, *Lagenorhynchus obliquidens*, may occur in herds of up to 2000 animals. Pacific white-sided porpoises produce broadband clicks and whistles. The whistle may occur in pulse trains or as a raucous bleat with independent dual components (reference 25). Distinct line components extend as low as 1.5 kHz in Pacific white-sided porpoise sounds. Pacific white-sided porpoise occur from Baja California to the Aleutian Islands and in Japanese waters. A related species, *Lagenorhynchus acutus*, occurs in colder waters of the North Atlantic, and *Lagenorhynchus obscurus*, occurs in the South Pacific and South Atlantic oceans. The different species probably produce distinct sounds.

(U) The saddleback porpoise, *Delphinus delphis*, produces broadband clicks and narrowband whistles that have been recorded in the 10- to 20-kHz band and as low as 5 kHz (reference 18). The saddleback porpoise occurs in large groups in warmer waters of the Atlantic, Indian, and Pacific oceans.

~~SECRET~~ All small whales produce some sustained narrowband signals that could be used in a (GMP) communication scheme for ranges less than 10 nmi. The sounds' high frequencies are subject to high attenuation. Small whale sounds might have utility for short-range communication at low levels to limit the chances of distant interception.

~~SECRET~~

PINNIPEDS (U)

(U) The Weddell seal, *Leptonychotes weddelli*, emits narrowband pulses at repetition rates from above 140 sec to one in several seconds (reference 26). The sounds' frequency range is from 50 to 10,000 Hz. The pulse trains typically start at 1 to 2 kHz with a fast repetition rate and end at about 0.1 kHz with slow repetition. Individual pulses in a train are frequency modulated from 2 kHz at 10 kHz to 50 Hz at 100 Hz. Weddell seals also produce howls, with fundamentals ranging from 50 to 4000 Hz and with strong harmonic structure, and ringing sounds in the 1- to 3-kHz range that last up to 10 sec. Weddell seals occur in the southern hemisphere around the Antarctic continent and its adjacent pack ice. Weddell seals migrate as far as 30°S to South America, to Australia, and to New Zealand.

(U) The bearded seal, *Erignathus barbatus*, emits a whistle with a tremolo characteristic caused by fast frequency modulation of a few hertz. The whistle is modulated further over several hundred Hertz at rates of about 1/sec to one in several seconds as the whistle drops 3 to 4 kHz to 0.2 kHz over a period of a minute (reference 27). The bearded seal is circumpolar in waters of the Arctic Ocean and the adjacent Atlantic and Pacific regions.

(U) The ringed seal, *Pusa hispida*, produces a number of sounds, including a steady discrete-component, downward frequency sweep imbued with harmonics (reference 28). The sounds last from about 1 to 4 sec, range from 5 kHz to 0.2 kHz and have at least four strong harmonics which may extend above 10 kHz. This seal also makes a broadband ringing sound in the frequency range from below 2 kHz to about 6 kHz, with durations up to 15 sec. The ringed seal occurs widely in the Arctic Ocean and on the north coasts of Europe, Greenland, North America and the Soviet Union.

(U) The ribbon seal, *Phoca (Histriophoca) fasciata*, produces two principal underwater sounds coincident with spring reproductive activities: an intense 1- to 5-sec downward frequency sweep in the 7- to 0.1-kHz region and a 0- to 5-kHz breathing-type sound of almost 1 sec duration but at 20 to 25 dB lower in pressure level (reference 29). This seal is distributed from the northeast Bering Sea to the Sea of Okhotsk and into the northern Sea of Japan. Ribbon seals also occur on the coasts of Korea and northern Japan.

(U) The California sea lion, *Zalophus californianus*, emits a variety of underwater sounds including barks, groans, growls, and bleats (references 28 and 30). The barks' main components occur between 0.5 and 1 kHz. Harmonics extend up to about 5 kHz. Most of the other California sea lion sounds occur in the frequency range of 0.1 to 1 kHz. The California sea lion occurs along the California coast, Baja California, the Galapagos Islands and the coast of Japan. Bulls occur as far north as Washington in the wintertime.

(U) Pinniped sounds usually occur within 10 nmi of coasts, ice packs or drifting ice.

~~SECRET~~

### SIGNAL DETECTION (U)

~~(C)~~ The COMBO Signal Recognizer, Second Generation, CSR-II (Figure 3), was designed and assembled, and then tested both in the laboratory and at sea. The signal recognition device can decode properly even if seven of the nine signals are lost. Information extraction logic uses read-only memory units (ROMs). The CSR-II can fill in missing information elements, average and weigh results, and display the best possible output. The word "BAD" appears in light-emitting diode (LED) displays when data are insufficient or do not conform to one of six message formats. The CSR-II accommodates broadband-processed bioacoustic signals. That is, given a technique to process sweeping signals, the CSR-II type decoding would also suffice for broadband data.

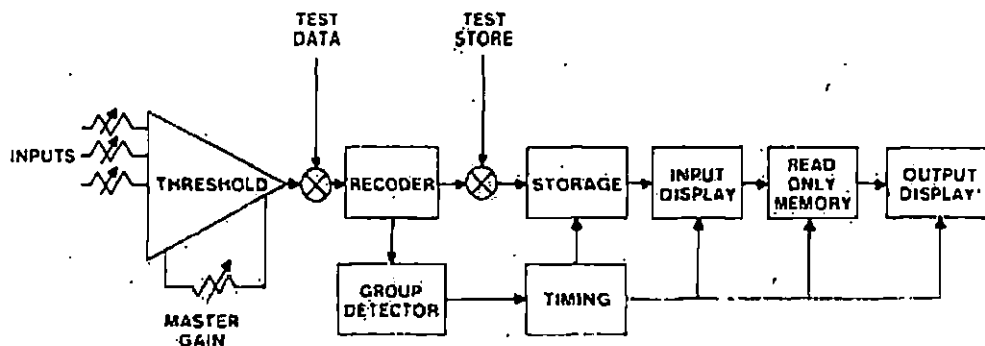

#### OUTPUT DISPLAY FORMAT

		TIME FRAMES		
GROUP	I	1	2	3
	II	4	5	6
	III	7	8	9

(UNCLASSIFIED)

(U) Figure 3. COMBO Signal Recognizer, CSR-II, elements and configuration.

### OPERATING FEATURES (U)

~~(S)~~ The CSR-II signal format is three mutually exclusive elements, each transmitted three times at different frequencies. The CSR-II produces six possible messages, using nine different transmitted frequencies. To compensate for frequency shifts during message transmission, the receiver accepts frequency "bands" centered on the possible transmission frequencies. The nine frequency bands are adjusted to match natural components in nine different pilot whale sounds, preselected according to the code of the day. The frequency bands are randomly arranged between 2.5 and 3.5 kHz and the CSR-II recognizes nine animal sounds spaced throughout a "natural" chorus of phonations (figure 4).

~~SECRET~~

~~SECRET~~

17

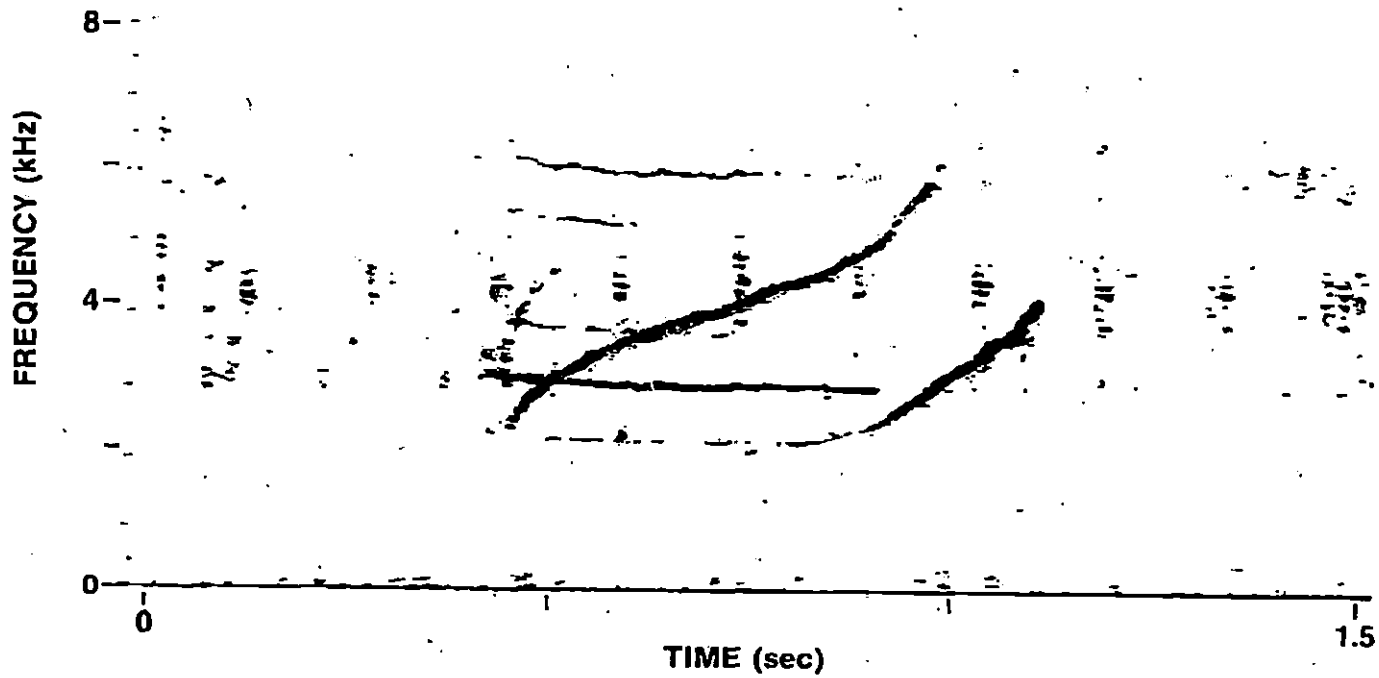

~~SECRET~~

~~CONFIDENTIAL~~

74 Figure 4. Sonogram of natural pilot whale sounds used in Project COMBO. Sounds from two whales are illustrated. Sounds with less frequency modulation contained message information. The coincident upslide sounds illustrated were not used to transmit information. Analysis filter bandwidth is 45 Hz.

~~SECRET~~

81 Pre-recognition processing in the CSR-II is tonal analysis with a real-time spectrum analyzer that is sweep-limited at 2.45 to 4.5 kHz and with an ensemble averager that uses eight averages. The analyzer is a Spectral Dynamics SD 301 and is the same analyzer used in the WQC-5 (LDR/QRP) fleet communication system. The averager is a Spectral Dynamics 309.

82 The entire spectrum in a selected format of animal sounds is projected into the water. Received data are first bandpassed between 1.25 and 5 kHz. We also use a three-dimensional waterfall display to characterize the received signals and ambient noise and to compare signals to natural sounds as they would appear to sonarmen on the BQR-20 or 22.

83 Each of the nine frequency bands is represented by an analog voltage from Spectral Dynamics Line Order Trackers that monitor the power spectra within a 36-Hz band about the center frequency. Analog voltages are compared to preset values and separated into a sequence of nine time frames divided into three time groups. Incoming data are displayed in LED displays corresponding to each time frame if the data coincide with the proper time group. For example, data shown by LED's 1, 2, 3 are obtained during time Group I, LED's 4, 5, 6 during Group II, and LED's 7, 8, 9 during Group III (figure 3).

84 Time frame generation begins when qualifying data in Group I are acquired. Additional qualifying inputs are sequentially strobed into the proper LED display and stored in memory for subsequent majority/complementary logic analysis. A Group II data acquisition during time Group I indicates that some previous data were missed and an automatic shift occurs to move the display to the proper frame.

85 Timing frames for which no data are acquired display an "E" for empty. Multiple acquisitions during a time frame are indicated with a point to the left of the number displayed in the frame. The first number received is displayed and the multiple acquisition is also stored in memory for later message extraction. After time frame 9, ROM passes horizontal, complementary logic in sequence on the rows of stored data and attempts to fill single voids accompanied by two bona fide inputs. For example, if the data for Group I were 3E1 in time frames 1, 2 and 3, respectively, a 2 will replace the E during the initial complementary logic pass to produce mutually exclusive message elements. By similar processing, other single voids or multiple acquisitions will be changed, e.g., 32E to 321 or 221 to 321. Multiple voids remain unchanged and serial multiple acquisitions display empty, e.g., 3.1.3 becomes 3EE. Majority logic scans each column of processed data sequentially and places the majority character for each column in a final best-message matrix. For example, if the first column contains 3E3 in frames 1, 4, and 7, respectively, a 3 will occur in the first position of the best-message matrix. Similarly, 2.32 in the second column produces a 2 in the second position of the best-message matrix, and EEE in the third column produces an E in the third position. A second complementary logic pass on the best message matrix attempts to fill voids before results are displayed in LEDs. If the final message is uncertain because of insufficient or conflicting data, the letters "BAD" are displayed in the LED instead of a final message. Single-bit, even parity is maintained throughout the logic passes. A point displayed in a final message frame indicates an inoperative ROM. After final message assembly, a decoder network activates solenoids or tape recorders to announce messages.

~~SECRET~~

~~SECRET~~

~~ST~~ Twenty hours of bioacoustic recordings with high signal-to-noise ratios were played into the CSR-11 without false alarm. The recordings included many pilot whale sounds because pilot whale sounds constituted the coded category of sounds. At times during the test, a single time window would qualify, but the message display was always "BAD". Lower signal recognition or triggering thresholds will increase incorrect message acceptance or "BAD" display, but a slow attack and slow release automatic gain control prevents this problem. The tests indicate that the chances of receiving spurious signals of the required frequencies in the right order and at the right times are infinitesimal. The time conditional coding of the COMBO scheme suppresses false alarms. Actual false alarm rates (FAR) depend upon equipment configurations for specific applications and conditions.

#### SEA TESTS (U)

~~ST~~ The COMBO concepts, systems and processing schemes were tested in the laboratory and at sea to improve transmission fidelity and measure performance. Initial tests used the CSR-1. A total of 76 consecutive repetitions of three different COMBO messages were correctly recognized and decoded by the 5-windowed CSR-1 in a test at the Transducer Evaluation Center on Point Loma. Sounds were played from a free-flooded cylinder to an omnidirectional hydrophone and a tape recorder at source levels up to 200 dB re 1  $\mu$ Pa. Signals were synthesized pilot whale sounds superimposed on a chorus recorded at sea. The CSR-1 is described and discussed in references 31 and 32.

~~ST~~ In July 1973, preliminary sea tests occurred off Catalina Island. The sounds, projector, receiver, processing technique and decoding method were the same as used in the TRANSDIEC tests. The projector and receiver were at a depth of 150 ft and at ranges of 0.01, 0.13, 0.25, 0.5, 1 and 2 nmi. The water column was well-mixed. Source levels were approximately 175 dB re 1  $\mu$ Pa. All recorded transmissions were decoded in the laboratory without error.

~~ST~~ In September 1973, the same COMBO message format was projected at levels to 200 dB re 1  $\mu$ Pa at sea to ranges of 5, 10, and 20 nmi. Instruments were the same as for previous tests. The receiver was a Wilcoxon hydrophone, M190A and the projector was a free-flooded cylinder, ITC 2014. Both instruments were at 250 ft. A specially designed 1-kW amplifier projected synthesized pilot whale sounds at source levels 25 dB above natural levels. Preprocessing and decoding were the same as in the previous field tests. The five signals were distributed through the frequency band from 4.4 to 6 kHz.

~~ST~~ The CSR-1 correctly detected all recorded messages (coded animal sounds) at the 5- and 10-nmi ranges and 90 percent of the messages at 20 nmi. Ambient noise conditions were near maximum Wenz shipping noise levels. Signal loss occurred at two of the five frequencies transmitted at 20 nmi.

~~SECRET~~

~~SECRET~~

~~187~~ Signal-to-noise ratios were determined on the real-time spectrum analyzer (table 1). At 5 and 10 nmi, the noise was nearly all chorus sounds projected by this system. At 20 nmi, ambient sea noise above 1 kHz masked the signals. Received level as a function of frequency is shown in figure 5. For reference, the source level of the 4.4-kHz signal was 200 dB re 1  $\mu$ Pa. Our measurements fit Urlick's attenuation loss model (reference 33).

~~187~~ In April 1975, a 90-sec tape-recorded sequence of nine COMBO pilot whale signals was projected at ranges of 2, 9 and 16 nmi. The natural tonals occurred in a frequency band from 2.5 to 3.5 kHz as part of a realistic chorus. Instrumentation was the same as for previous tests. Source levels and transducer depths are given in table 2.

~~187~~ Four COMBO sequences and a 3-kHz calibration tone were transmitted at each range.

~~187~~ Recorded sequences were played into the CSR-II system after processing with a real-time spectrum analyzer and line-order trackers. Messages were recognized perfectly at all ranges and signal-to-noise ratios (table 2). The received signal-to-noise ratios agree with the prediction for 3 kHz (table 3).

~~187~~ In the CSR-II system, both the bit rate and the signal-to-noise ratio required for message detection are frequency dependent. For example, assuming processing gain equivalent to that of the CSR-II system and a 90-percent probability of detection, a 16-dB signal-to-noise ratio for the spectrum level is required for a pilot whale whistle at 3 kHz that lasts 0.7 sec. For a 200-dB source level, the signal is theoretically detectable by CSR-II out to 100 nmi under average ambient noise and propagation conditions (table 3). With the same processing techniques, the signal-to-noise ratio decreases with frequency, but the data rate is reduced because more time is required for recognition at lower frequencies. For example, whale sounds below 100 Hz require a signal-to-noise ratio of -4 dB, but take 100 times longer to be detected than the 3-kHz pilot whale signal. Thus, the bit rate is reduced by a factor of 100.

~~187~~ Tests also were conducted to determine the utility of sonobuoys, especially the SSQ-11A, as receivers. The only limiting factor was radio range, which is line of sight. COMBO signals received and relayed by sonobuoy were processed, recognized and decoded normally. Successful tests of CSR-II were made in the laboratory using data projected up to 3 nmi to sonobuoys 5 to 7 nmi offshore.

~~187~~ Tests with parametric sources were made in cooperation with personnel of the Naval Underwater Systems Center (NUSC). A primary frequency of 66 kHz was mixed with COMBO sounds and projected in the NUSC quarry at a source level of 173 dB. We decoded the recorded signals with the CSR-I with 99-percent probability of correct detection. Sounds above 1 kHz were received with high fidelity, but 20-Hz to 1-kHz sounds lacked fidelity. In particular, killer whale and pilot whale sounds transmitted well, whereas blue whale and Wedell seal sounds were garbled and degraded by noise.

~~SECRET~~



Frequency (kHz)	Original <sup>2</sup> Tape	5 nmi	10 nmi	20 nmi (a) <sup>3</sup>	20 nmi (b)	20 nmi (avg)
4.40	23	21	17	14	17	15.5
4.84	12	14	13	9	12	10.5
5.20	21	21	17	19	15	17.0
5.40	20	20	13	9	12	10.5
6.00	18	18	15	12	8	10.0
Grand Average:	19.0	18.8	15.0	12.6	12.8	12.7

- 1 Values read directly from the CRT display of the real time spectrum analyzer after 8 averages. The analytic bandwidth is 60 Hz.
- 2 S/N ratio determined directly from magnetic tape used for transmission. Each ratio represents an average from 6 sounds at each frequency.
- 3 Two runs were made at 20 nmi (a,b) for a total of 60 transmissions of coded signals at this range.

(UNCLASSIFIED)

(U) Table 1. Signal-to-noise ratios (dB)<sup>1</sup> from Project COMBO transmission tests, September 1973.

~~SECRET~~

21

~~SECRET~~

~~SECRET~~

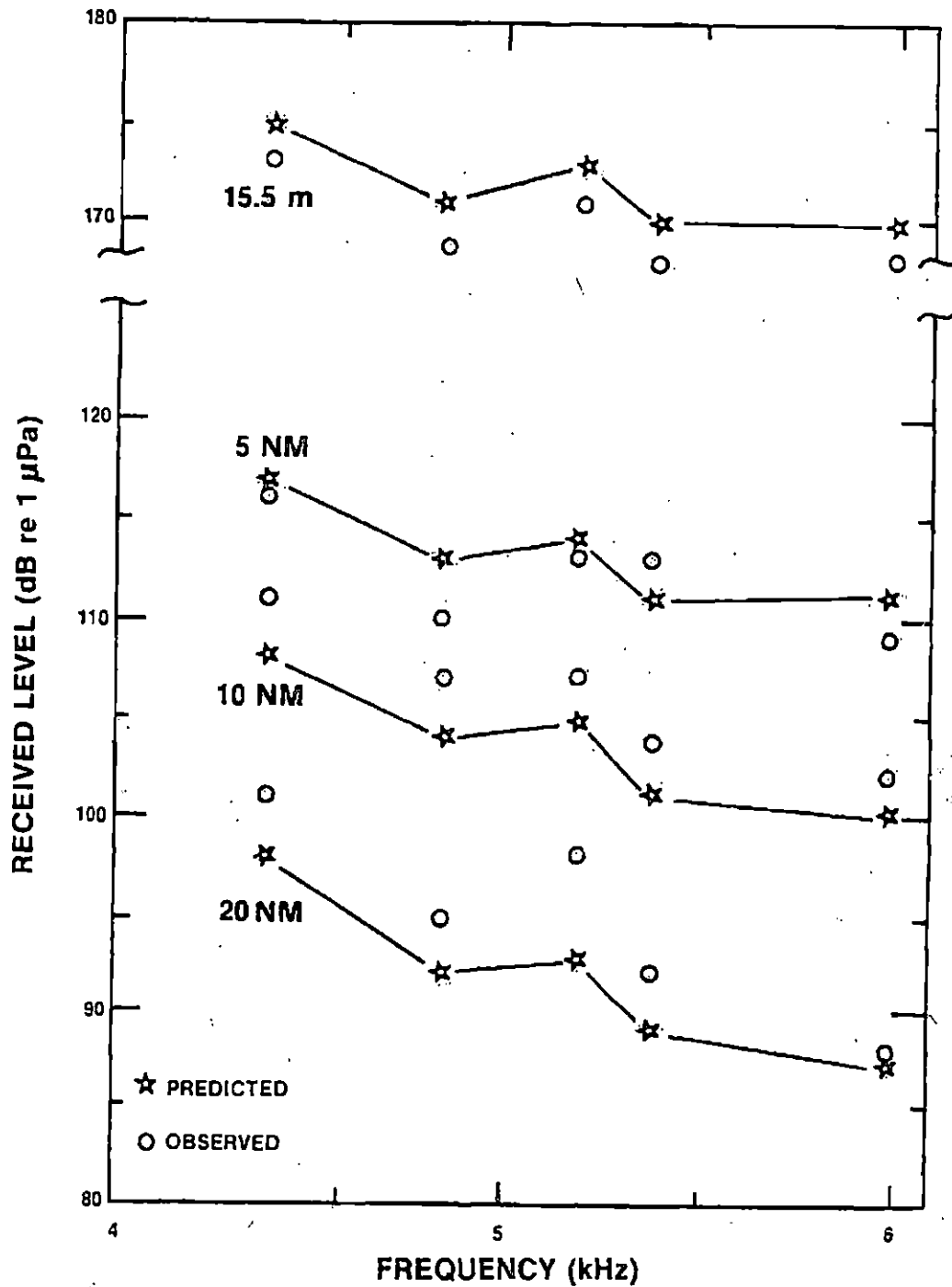

~~(CONFIDENTIAL)~~

(U) Figure 5. Received level of COMBO signals measured in CSR-I tests and predicted levels from Urlick (reference 33). Each plotted measurement is an average from 6 COMBO signal transmissions.

~~SECRET~~

(C) Signal-to-Noise summary for sea tests with coded pilot whale sounds in April 1975. Values are the range for 9 coded signals transmitted at 9 different frequencies between 2.5 and 3.5 kHz. Source and receiver were at 90m in 1300m of water. Received broadband ambient noise was 102 to 107 dB re 1  $\mu$ Pa. Source levels were from 179 to 198 dB. Strong multipaths occurred at the 2 and 9 nmi ranges. Four trials were run at each range. All messages were correctly recognized with the CSR-II apparatus.

Range (nmi)	Broadband Noise <sup>1</sup>	Noise in 1 Hz Band <sup>2</sup>	Signal-to-Noise Ratio (dB)	
			Predicted <sup>3</sup> (Highest)	(Average)
2	4 to 13	55 to 64	45	62
9	-14 to 0	44 to 58	30	57
16	-17 to -1	40 to 56	23	50

1 Broadband noise from 20 Hz to 15 kHz, measured from calibrated recordings taken at sea.

2 From one-third octave measurements at signal frequencies.

3 Predicted Spectrum level of Wenz noise values for 190 dB source.

~~(CONFIDENTIAL)~~

(U) Table 2. Signal-to-noise summary, April 1975.

~~SECRET~~

23

~~SECRET~~

f (kHz)	2mm		9mm		16mm		25mm		50mm		100mm	
	H	A	H	A	H	A	H	A	H	A	H	A
10	63	88	35	60	16	41	-6	19	-63	-38	-12	-157
5	59	85	41	67	32	58	23	49	2	28	-37	-11
4	58	84	41	67	34	60	27	53	9	35	-20	6
3	55	82	40	67	33	60	27	54	14	41	-8	19
2	54	79	39	64	33	58	28	53	18	43	1	26
1	48	75	34	61	29	56	25	52	18	45	7	34
.5	46	69	32	55	28	51	25	48	19	42	12	35
.2	45	62	32	49	28	45	25	42	20	37	15	32
.1	41	56	28	43	24	39	21	36	16	31	12	27
.05	36	51	23	38	19	34	16	31	12	27	7	22
.02	27	45	14	32	10	28	7	25	3	21	-2	16

(UNCLASSIFIED)

(U) Table 3. Received signal-to-noise ratios/Hz. in dB, predicted for a 200 dB source at different ranges under high (H) and average (A) ambient noise conditions. Based on Wenz ambient noise levels and reference 33.

~~SECRET~~

~~(S)~~ In June 1974, COMBO sounds were transmitted between the submarine *Dolphin* and a receiving ship 0.5 to 4.5 nmi away. All COMBO signals were recognized by the CSR-II. In a long-range test, the signals were too weak to be automatically detected at 50 nmi.

#### RECOMMENDATIONS FOR DEVELOPMENT (U)

~~(S)~~ CSR-II is a test system to evaluate message rates, frequency constraints, ranges, and covertness available through the COMBO concept. The CSR-II requires modification to increase message content, processing speed and coding variability to be compatible with fleet systems.

~~(S)~~ The number of messages can be increased by using more signal frequencies. For example, increasing the number of signal frequencies in a transmission from 9 to 21 would increase the number of triple-redundant signals from 3 to 7 and the number of possible messages from 6 to 5040.

~~(S)~~ Doppler tolerance can be improved by using wider filter pass bands. Assuming differential speeds of 60 knots and pilot whale signals, more than 21 adjacent filters of increasing bandwidth can be used. Increasing bandwidth is needed to accommodate greater doppler shifts at higher frequencies. Reduced ambient noise levels at the higher frequencies nearly compensate for the increased noise passed by wider filters.

~~(S)~~ Automatic Gain Control (AGC) would eliminate the manually adjustable gain. Noise varies with frequency; thus a separate AGC should be used for each frequency band.

~~(S)~~ Transmission time can be reduced by using parallel coding and decoding. The CSR-II system transmits serially one 10-sec window at a time and requires at least 90 sec of acoustic data for one message. Parallel coding would update an input pattern every 50 msec and require about 20 sec to transmit 21 signals, or one of 5040 possible messages with triple redundancy. Actual transmissions will be longer than 20 sec to add the realism provided by ~~randomized amplitude variations of natural choruses~~

#### SIGNAL SYNTHESIS (U)

##### ANALYSIS OF MARINE MAMMAL SOUNDS (U)

~~(S)~~ Synthesis of naturally-occurring sounds depends upon the analysis of recordings from the sea. Proper analysis includes real-time spectral estimation, digital and analog waveform studies, digital filtering, and instantaneous amplitude and zero-crossing estimation. The sounds' spectrum contains information about the sounds' frequency range and harmonic content. The waveform suggests source generation mechanisms and, hence, possible synthesis procedures. Operator-interactive digital filtering isolates individual sounds and enhances signal-to-noise ratios.

~~SECRET~~

~~SECRET~~

## TECHNIQUE OF COMPUTER SYNTHESIS (U)

### MARINE MAMMAL "SCREAMS" (U)

~~(C)~~ Marine mammal sounds called "screams" and "buzzes" can be composed of pulses with varying repetition rates and varying frequency content. Small whales and killer whales produce such sounds.

~~(C)~~ A time-frequency waterfall plot of a simulated killer whale sound is shown in figure 6. The basic pulse was generated by low-pass filtering the harmonics of a rectangular pulse, with a repetition rate that varied from 1000 to 200 Hz. The frequency harmonics of an actual killer whale sound have absolute frequency components that are different from the simulated scream because the pulse shapes differ (figure 7).

~~(C)~~ Marine mammal sounds include long sinusoidal oscillations, called "whistles", as well as short-duration pulses. Whistle synthesis uses procedures different from pulse synthesis. Sinusoidal sounds have been synthesized (reference 34); synthesis of pulses and clicks remains unfinished.

~~(C)~~ Pilot whale whistles are sinusoidal, i.e., the sound's instantaneous time waveform can closely resemble a sine wave. Only the instantaneous amplitude and frequency vary over the duration of the sound. The amplitude is likely to rise smoothly over about 50 msec to an average level, to remain at the level, and to decrease smoothly during the last 50 msec of the sound. The sounds lack transient onsets or offsets that are humanly discernible. The sounds contain both frequency sweeps and constant-frequency portions.

~~(S)~~ Whistle synthesis requires real-time, high-speed computational capability. The COMBO synthesis work used a PDP-11/40 minicomputer. High-speed digital-to-analog (D/A) conversion of the generated sounds required a first-in, first-out (FIFO) memory-based D/A converter. Smooth sine waves were generated by limiting the output of the D/A band with an active filter. The synthesis software program has a self-contained lookup table that contains the microstructure of the sound to be synthesized (reference 34).

~~(C)~~ The microstructure table can represent various wave shapes. One table generates pure sine waves, and others superimpose second and third harmonics. Program execution speed limits the real-time high-frequency to 7 kHz. The frequencies to be produced are stored separate from the generation program. Thus, a sound can be generated repetitively or as a sequence. The generation program constructs the pattern and fills the FIFO memory of the D/A converter with the output samples. The FIFO is clocked at a fixed 61- $\mu$ sec interval. In addition, the onset and offset of the sounds are program controlled. The program is not limited by FIFO memory size. Between clock intervals, new digital samples are loaded into the FIFO memory. Figures 8 and 9 show time-frequency waterfall displays of computer-synthesized pilot whale whistles.

~~SECRET~~

~~SECRET~~

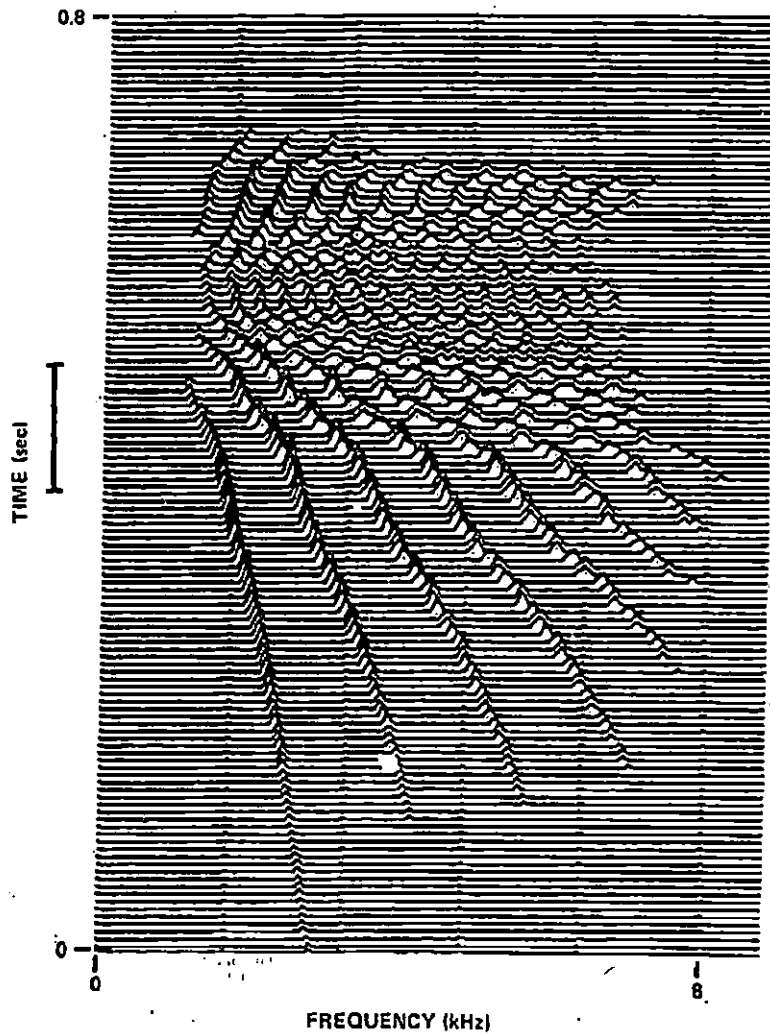

FREQUENCY (kHz)

(UNCLASSIFIED)

(U) Figure 6. Time-frequency-waterfall plot of a simulated killer whale sound. Time bar equals 100 msec.

~~SECRET~~

~~SECRET~~

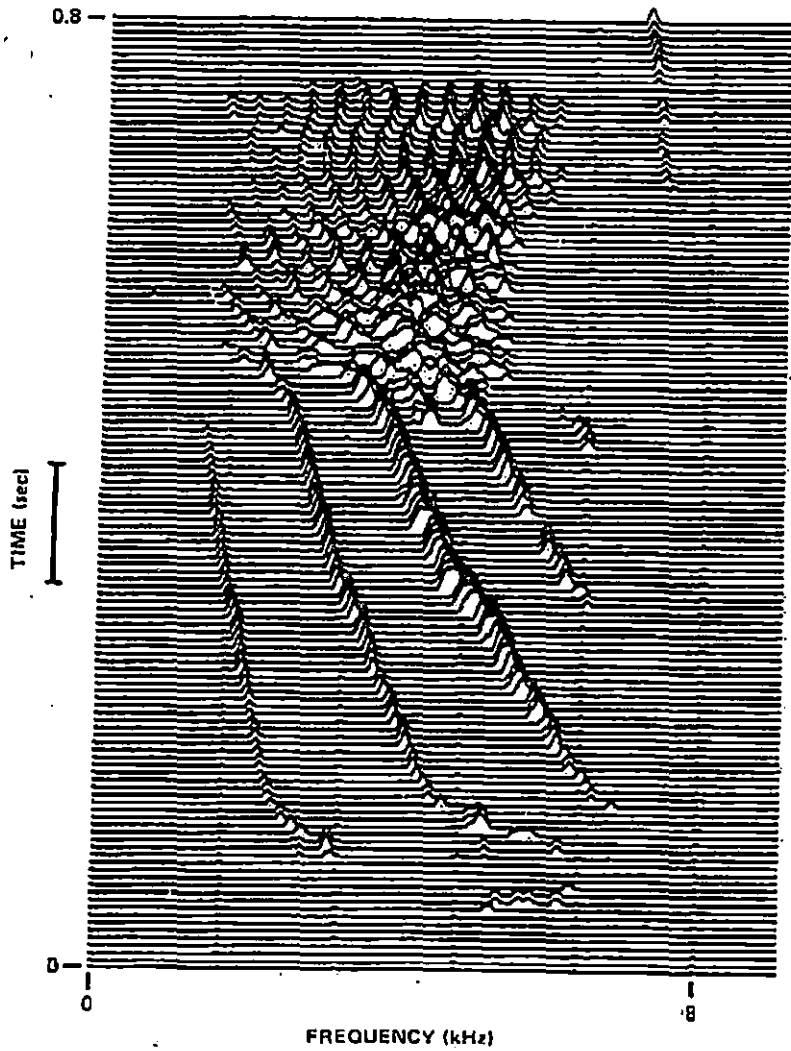

FREQUENCY (kHz)

(U N C I A S S I F I E D)

(U) Figure 7. Time-frequency waterfall plot of a natural killer whale sound. Time bar equals 100 msec.

~~SECRET~~



~~SECRET~~

29

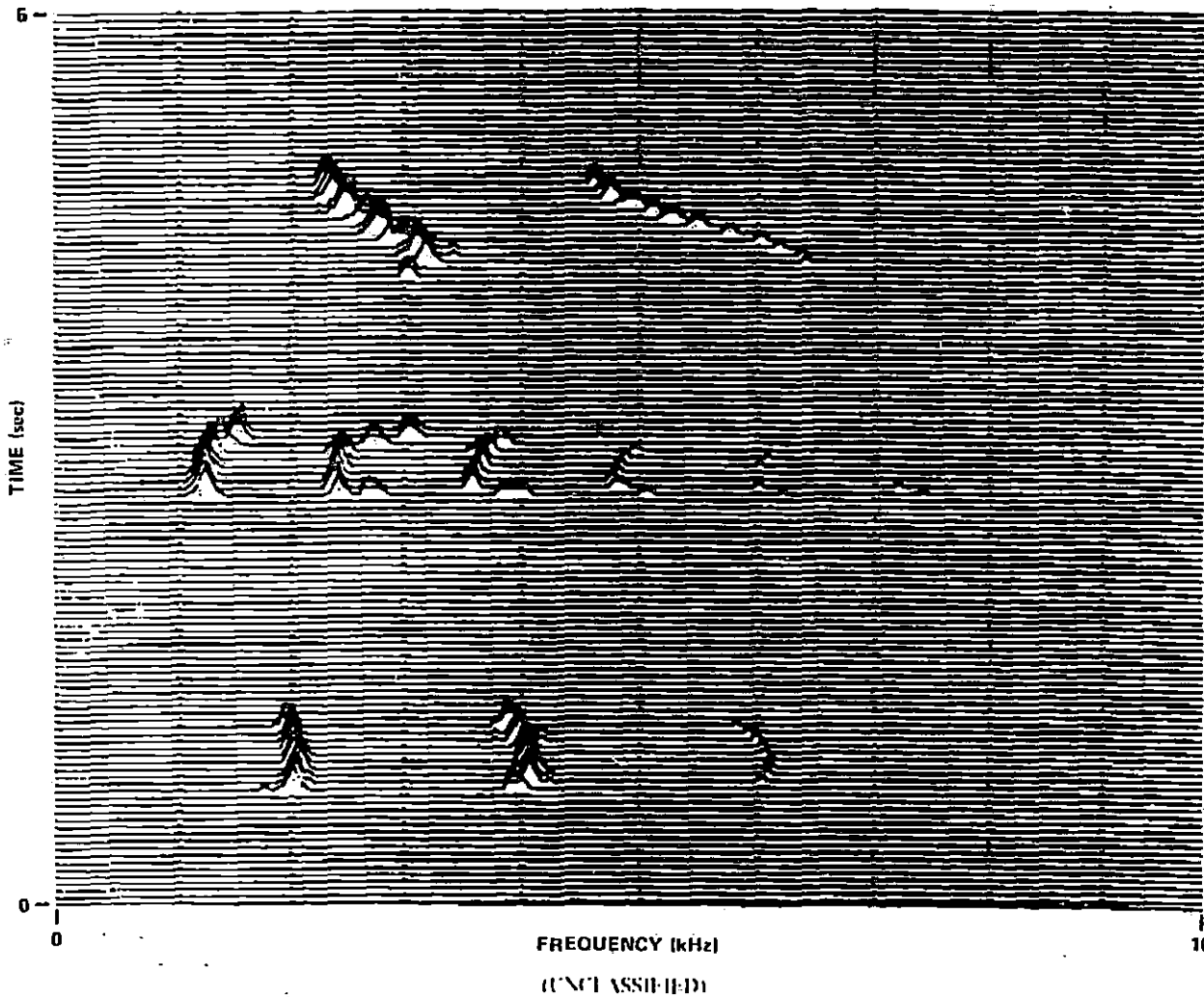

~~SECRET~~

U U Figure 8. Waterfall display of computer-synthesized, pilot whales sinusoidal whistles after digital-to-analog conversion and 5 kHz low pass filtering.

~~SECRET~~

30

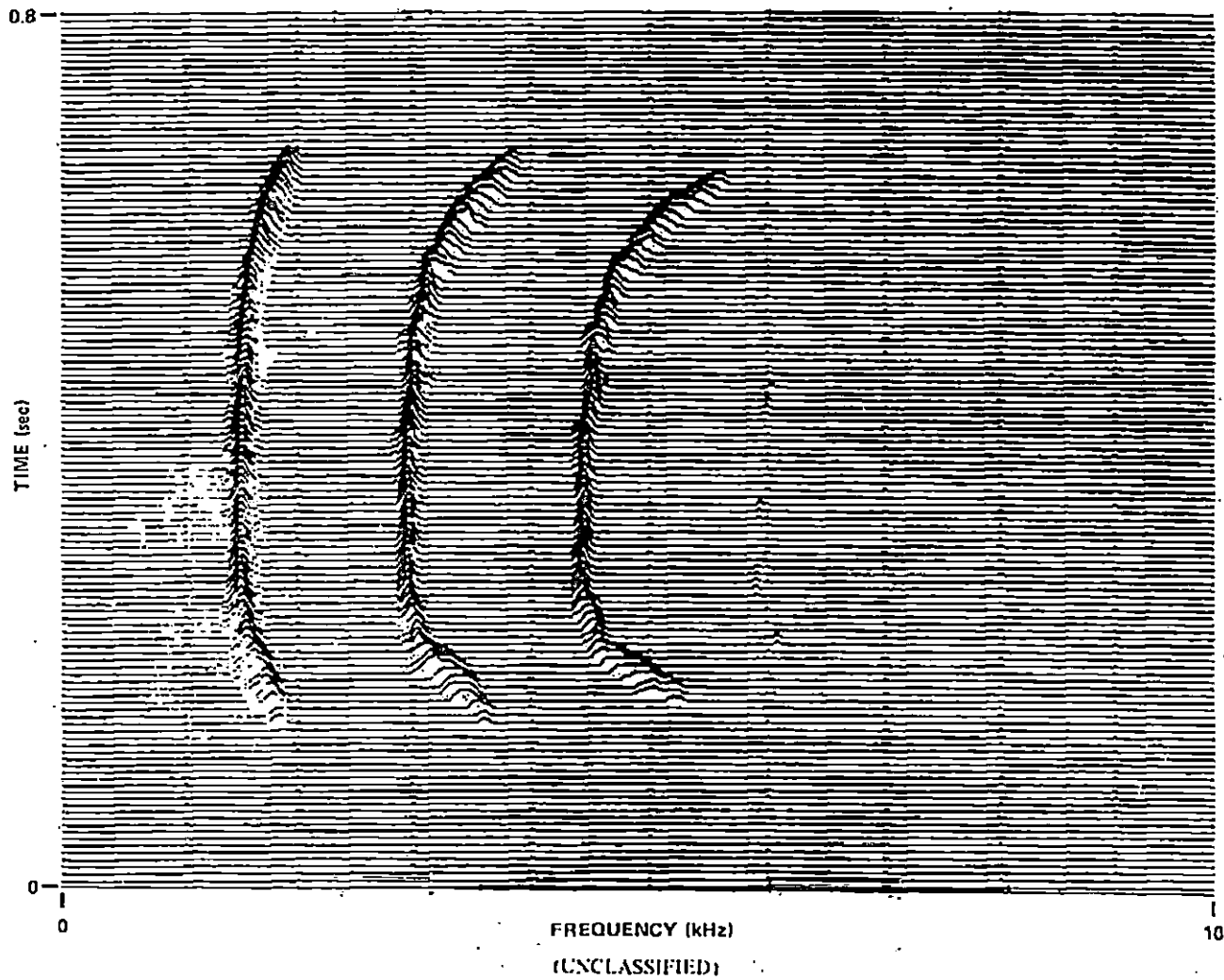

~~SECRET~~

(U) Figure 9. Expanded waterfall display of the middle set of computer-synthesized whistles from figure 8.

~~SECRET~~

~~(S)~~ The synthesis of pilot whale sounds requires an ability to describe the sounds' microstructure and to choose the generated frequencies. For applications not requiring real-time generation, sounds can be tape-recorded. Recorded sounds would have an upper frequency limit about 7 kHz. Methods of sound synthesis involve signal generation techniques and computer software but the upper frequency of synthesized sounds is limited by hardware.

## TRANSDUCERS (U)

### BACKGROUND (U)

~~(S)~~ Transducers for transmitting and receiving COMBO low-data-rate messages should have the following characteristics:

- o A frequency range of 20 Hz to 10 kHz.
- o A source level of 160 to 200 dB re 1  $\mu$ Pa at 1 m, and
- o A projector signal-to-noise ratio of at least 55 dB.

Different transducers may be required to transmit different types of sounds.

(U) We surveyed 27 transmitting and 9 receiving systems to identify transducers acceptable for COMBO use.

~~(S)~~ Sound projectors transmit most effectively in a relatively narrow frequency band. For some projectors, the effective band is wide enough for COMBO application with certain sounds, but no projector is suitable for all COMBO sounds. For example, COMBO codes tonals in pilot whale phonations from 1 to 3 kHz, but the animal's sonic repertoire extends from 300 Hz to 15 kHz. The COMBO scheme is directed toward use of fleet sonar equipment, but other transducers were surveyed because fleet equipment does not fulfill all COMBO requirements.

~~(S)~~ No fleet sonar system projects effectively over the frequency band required for all low data rate transmissions in the COMBO scheme, so we considered projectors with regard to the kind of sounds that could be projected. The sounds' animal sources were classified by frequency limits. High-frequency animal sources produce sounds in the 500- to 8000-Hz range. Small whales and porpoises, specifically beluga, killer and pilot whales, are high-frequency sources of COMBO sounds. Components of small whales' signals may exceed 8 kHz, but attenuation limits communication utility of the signals' higher frequencies. Mid-frequency animal sources produce sounds in the 70- to 3000-Hz range. Some large whales, such as humpbacks, and most pinnipeds are mid-frequency COMBO sources. Low-frequency animal sources produce sounds in the 20- to 200-Hz range. Large whales, such as blue, finback and gray whales, are low-frequency COMBO sources. Because the frequency limits overlap, some animals are sources in two categories.

### FLEET PROJECTORS (U)

~~(S)~~ Fleet sonars applicable to COMBO applications are listed in table 4. Inadequate low frequency response limits most of the units. Only GNATS satisfies a complete subtask category, namely the mid-frequency segments. The GNATS system uses three transducers and each transducer operates in a distinct frequency range (reference 35).

~~SECRET~~

~~181~~ The WQC-2 low-band projecting transducer system could be equalized to provide adequate response from 1.1 to at least 5 kHz, at a source level of approximately 190 dB re 1  $\mu$ Pa at 1 m. Alternatively, sounds could be preequalized for use with the system. Use of the WQC-2 driving amplifier in a COMBO scheme would require auxiliary input from a flat response circuit. The WQC-2 is installed on submarines and surface vessels for communications.

~~181~~ The frequency response of the WQC-2 is too narrow for the entire range of the high-frequency category of sounds, but is adequate for COMBO transmissions of killer whale, false killer whale, beluga, and bottlenose porpoise sounds.

~~181~~ The frequency response of the SQQ-23 with an auxiliary amplifier and of the BOS-13 in a communications mode nearly equals the response of the WQC-2. The BOS-13 is limited below 2.5 kHz and is thus limited to transmitting porpoise-like sounds in a COMBO communications application.

~~181~~ The GNATS system frequency range is suitable for transmitting high- and mid-frequency category animal sounds, but the system has a maximum 160-dB source level capability. COMBO sounds require 180- to 190-dB source levels to achieve adequate communications range. Another possible disadvantage to COMBO application of the GNATS system is that only 10 GNATS sets were built, and the availability of units is questionable.

~~181~~ Our survey indicates that fleet sonar projectors are most suitable for projecting COMBO animal signals in the high-frequency category.

#### OTHER PROJECTORS (U)

~~181~~ Other projectors surveyed meet certain COMBO criteria. Several projectors have potential use for acceptable COMBO transmissions (table 5). Except for the Honeywell HX 182-A, the listed projectors are small and lightweight. The NOSC PHD IV is the only transducer surveyed that can project broadband sound at frequencies as low as 20 Hz with no significant distortion (figure 10). Disadvantages of the NOSC PHD IV for COMBO communications applications include its upper source level limit of 156 dB, the absence of active depth compensation, and a minimum frequency limit that increases with depth.

~~181~~ The ITC 2010 and 2011 projectors cover a broad frequency band and operate at an adequate source level. The ITC units are small and omnidirectional in the plane normal to their axes. Together, the ITC projectors have been successfully used in COMBO sea tests.

~~181~~ The parametric system from the Naval Underwater Systems Center (NUSC) is broadband above 1 kHz and is suitable for projecting COMBO sounds of porpoises and small whales (figure 11). The parametric system is very directional and may project unwanted output at primary frequencies that will fall within the detection range of COMBO signal recognition instruments.

~~181~~ The Honeywell HX 182-A projector operated satisfactorily at frequencies from 60 to 1100 Hz (figure 12). The projector is inadequate for COMBO signals in the low- or

~~SECRET~~

System	Deployment	Frequency, kHz	Maximum Undistorted Source Level, dB re 1 $\mu$ Pa at 1m
1. WQC-2 (Low Band)	Surface/Submarine	1.5 - 5	190
2. SQQ-23	Surface	1(?) - 8	200+
3. BQS-13 (Comm Mode)	Submarine	2.5 - 8	200+
4. GNATS	Submarine	0.06 - 6	160+

~~(CONFIDENTIAL)~~

(U) Table 4. Fleet sonars considered for COMBO-like applications.

Transducer	Frequency Response kHz	Source Level dB re 1 $\mu$ Pa, 1m	Operating Depth Limit, m	Configuration	Approximate Size, m
NUC PHD IV	0.01 - 0.1	150	No data	Cylinder	0.4 Dia x 0.5
HX 182-A	0.06 - 1.1	190	230	Cylinder	0.6 Dia x 1.8
ITC 2010	1 - 4	180+	Unlimited	Ring	0.5 Dia x 0.3
ITC 2011	4 - 9	190+	Unlimited	Ring	0.2 Dia x 0.1
NUSC Parametric	1 - 20	195+	91	Disc	0.9 Dia x 0.1

(UNCLASSIFIED)

(U) Table 5. Non-fleet projectors considered for COMBO-like applications.

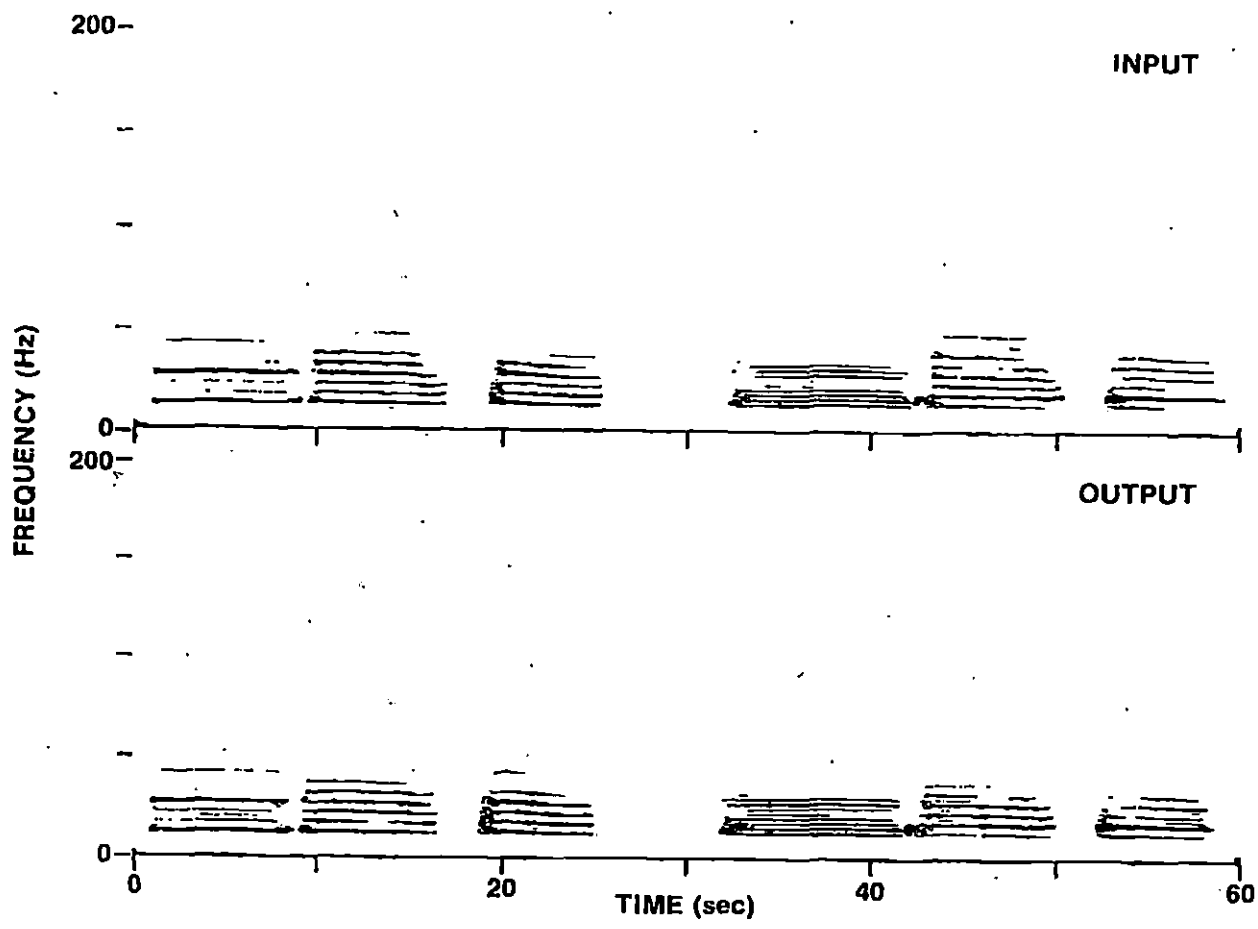

(UNCLASSIFIED)

(U) Figure 10. Sonograms of blue whale sounds re-recorded directly from the playback tape recorder ("input", above) and after projection by the PHD IV transducer at 9 m depth ("output", below). The effective analysis filter bandwidth is 1.1 Hz.

~~SECRET~~

34

~~SECRET~~

~~SECRET~~

35

TIME  
↑

FREQUENCY  
→

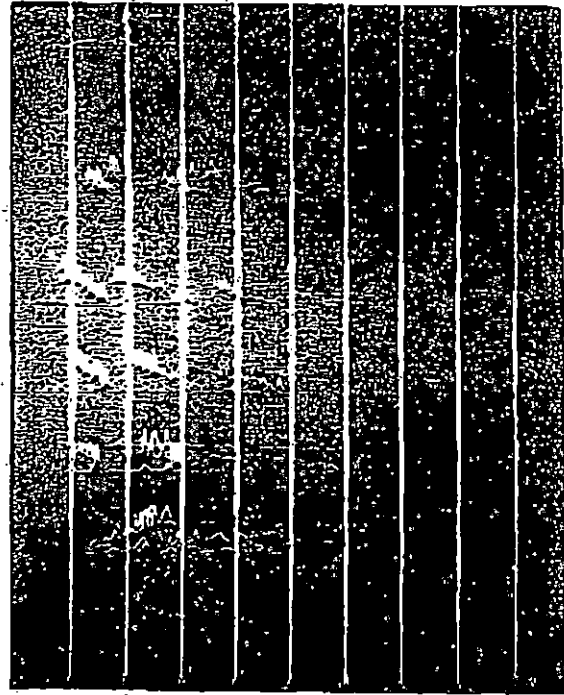

TRANSMITTED

SPECTRUM ONE

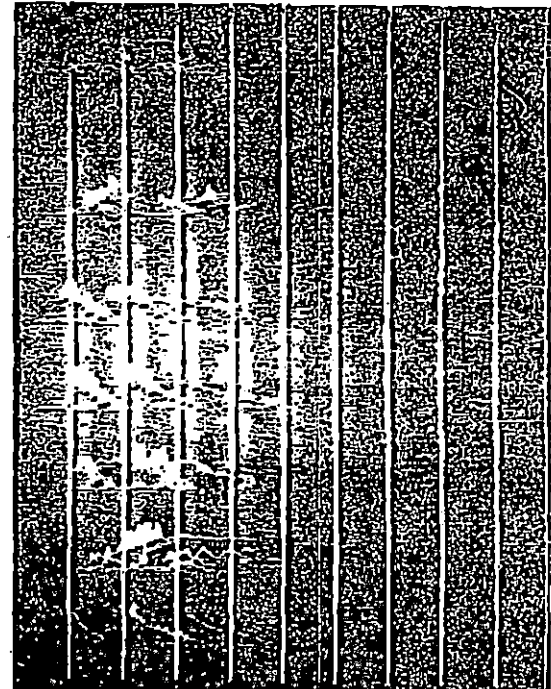

RECEIVED

~~SECRET~~

(UNCLASSIFIED)

U.S. Figure 11. Waterfall displays of killer whale spectra. The receiver was a NUSC 65 AF parametric projector. The transmission range was 90 m.

~~SECRET~~

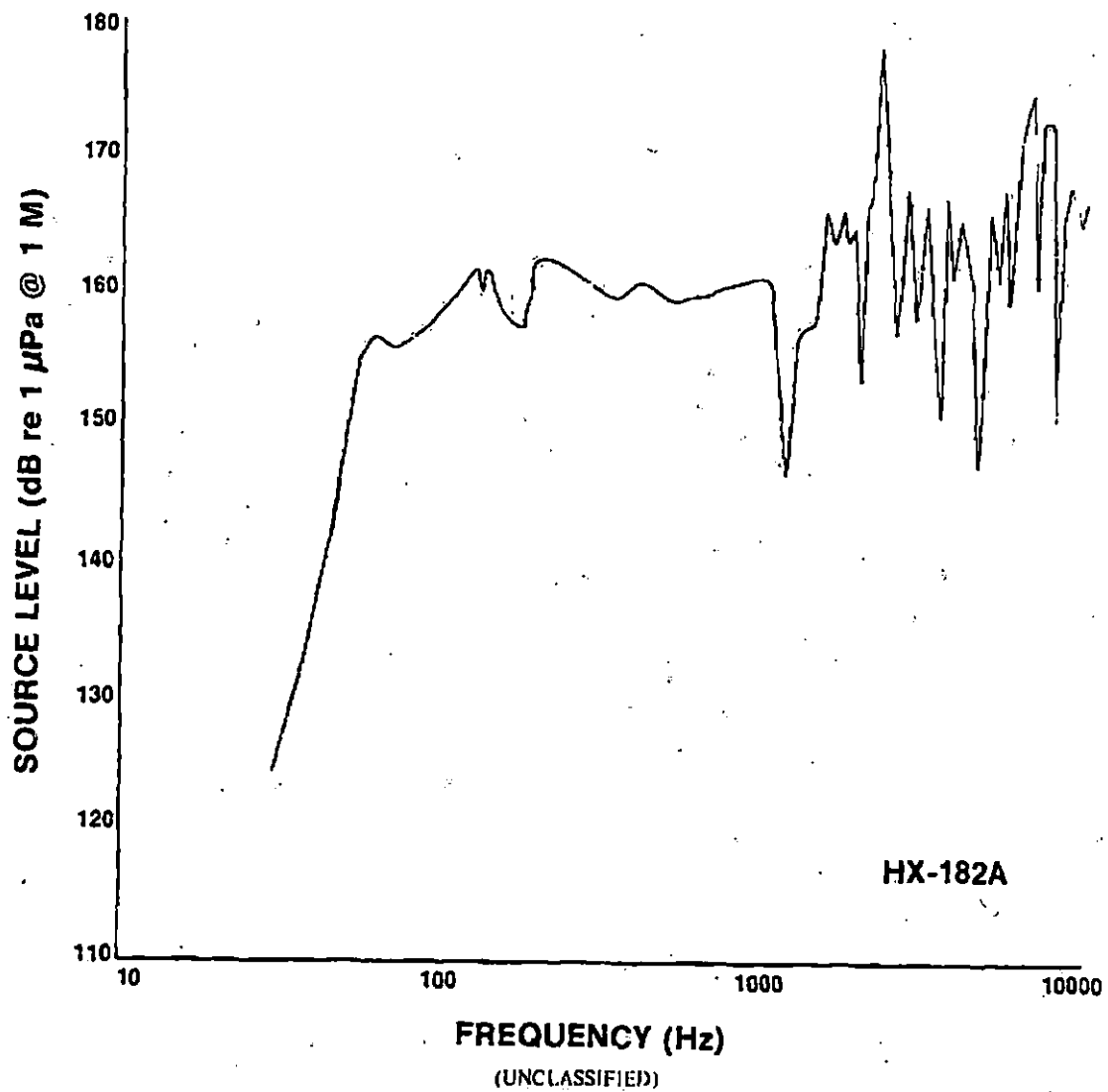

(U) Figure 12. Response of HX 182-A projector in series with a 110-to-200 Hz band rejection filter. The input signal was 100 V rms at 400 Hz. The source depth was 62 m.

~~SECRET~~



~~SECRET~~

mid-frequency categories. A fleet sonar used in conjunction with an HX 182-A and a PHD-IV would be capable of COMBO transmissions at frequencies from 20 to 10,000 Hz.

#### LOW-FREQUENCY PROJECTORS (U)

(U) Six low-frequency projectors surveyed are described in table 6. The hydraulic mechanisms of the hydroacoustic devices listed produce unacceptable harmonic distortion and extraneous components. The HX 254-B uses a different pressure compensation system than the HX 182-A. All projectors listed in table 6 have greater source levels and less depth sensitivity than the PHD-IV.

#### FLEET RECEIVING TRANSDUCERS (U)

~~(S)~~ Our survey indicates that receivers meeting COMBO criteria are available in the fleet (table 7). The receiving response of the WQC-2 is narrowest of the surveyed units. For existing transducers, the SQJ-23 is best for COMBO application for surface ships and the BQR-7 is optimal for submarines. Towed arrays give extended low-frequency coverage, but their use is restrictive. A broadband hydrophone will be necessary for surface ships to receive COMBO sounds. The BQR-7 enables submarines to receive COMBO sounds at frequencies as low as 50 Hz.

~~(S)~~ Surface ships can also use sonobuoys to receive COMBO signals in the entire 20- to 10,000-Hz frequency range. A sonobuoy deployed away from a surface ship would likely receive less ownship noise than hull-mounted receivers. Antenna height limits sonobuoy radio range. Depending on sea state, a surface ship moving at 20 kt should receive COMBO signals from a sonobuoy for 15 to 30 min.

#### DEPLOYMENT SECURITY (U)

~~(S)~~ Covert and secure application of the COMBO communications scheme requires that the bioacoustic signals have adequate natural qualities. Acoustic criteria for signal naturalness include fidelity, source level, frequency content, waveform, amplitude and duration. Specific signals also must occur at times and locations proper for source animals.

#### TRANSDUCERS (U)

~~(S)~~ No underwater sound projecting equipment can transmit bioacoustic signals with absolute fidelity. Signal analysis can reveal the perturbations that transducer systems impose on transmissions and can identify unnatural bioacoustic signals. Transducers that project bioacoustic signals for communications must limit the transmitted perturbations so the signal variability occurs within normal limits for a knowledgeable listener.

#### SOURCE LEVELS (U)

~~(S)~~ Communication applications of bioacoustic signals may require higher-than-natural source levels to overcome propagation loss factors and to achieve sufficient communications ranges. The source levels of phonations by large whales are adequate for most

~~SECRET~~

~~SECRET~~

38

~~SECRET~~

<u>Transducer</u>	<u>Frequency Response, Hz</u>	<u>Source Level, dB re 1 <math>\mu</math>Pa, at 1m</u>	<u>Operational Depth Limit, m</u>	<u>Configuration</u>
Honeywell HX 254-B Bender Bar	25 - 100	180	450	91 cm Dia x 120 cm plus depth compensator, 900 kg, towed
Magnavox Bender Bar	Resonant at 50 Hz	180	450	43 cm Dia x 81 cm, 135 kg
General Dynamics Hydroacoustics	60 - 105	180	460	53 cm Dia x 245 cm, 730 kg, towed
Moog Hydro- acoustic	40 - 400	180 at 55 Hz	155	455 kg
Westinghouse Flexural Disc	10 - 100	190 (Broadband) 200 (Discrete Freq)	No data	1800 kg
Aerojet Electro- systems Flexural Disc	25 - 95	199	No data	0.24m <sup>3</sup> , 455 kg

~~(CONFIDENTIAL)~~

(C) Table 6. Low-frequency projectors surveyed for possible COMBO-like applications.

~~SECRET~~

System	Deployment	Frequency, kHz
SQQ-23	Surface	0.5 - 6
BQR-7	Submarine	0.1 - 7
BQS-6, 13	Submarine	0.5 - 8
SQR-17 (TASS)	Submarine	0.01 - 1.1
BQR-15 (STASS)	Submarine	0.05 - 2.5

~~(SECRET)~~

(U) Table 7. Fleet receivers suitable for possible COMBO-like applications.

COMBO applications. Communication signals that use phonations of other marine mammals may have to exceed natural source levels by up to 30 dB. Source level is a function of the transmission's coded frequency and intended range. Use of unnaturally high source levels should be limited to short-duration transmissions and low frequency sounds.

#### SIGNAL SYNTHESIS (U)

~~(S)~~ Signal synthesis has reproduced portions of pilot whale sinusoidal waveform whistles. The sounds of large whales have not been synthesized. Adequate synthesis of bioacoustic signals for covert communications requires quality recordings of natural sounds. Synthesized signals are constructed from and compared with the natural templates. Synthesized signals must appear natural on sonar displays and must sound natural to knowledgeable listeners.

~~(S)~~ The formats presenting bioacoustic communications signals must also be natural. The increase in critical bandwidth with frequency in animals' auditory function implies that bandwidth of animal sounds also increases with frequency. Thus, synthesized animal signals that sweep across frequency should have more frequency variance in the high-frequency portion. Some formats, such as the amplitude rise and decay of choruses, change gradually and vary randomly. Other formats, such as humpback whale songs, occur in distinct rhythmic sequences that are repeated as stanzas.

~~(S)~~ Ensembles upon which coded signals are superimposed must be randomly constructed. The library of component synthesized sounds must be large enough that long-term analog recordings are nonrepeating.

~~(S)~~ During sea trials of COMBO equipment, transmission of synthesized pilot whale sounds attracted pilot whales to the transmitter. The whales' phonations added to the sonic environment without degrading the communications effort.

~~SECRET~~

~~SECRET~~

### SIGNAL OCCURRENCE (U)

~~(S)~~ Bioacoustic communication signals must occur at the proper time and place. No marine mammal is pan-oceanic and many distinct phonations occur only at certain times or places. The frequency with which a bioacoustic communication will be used depends upon the communicators' activities. More common signals should be used for more frequent communications.

~~(S)~~ A guide to biologics has been produced to familiarize sonarmen with bioacoustic signals, bioacoustic sources, and marine mammal distribution (reference 12).

### FLEET IMPACT (U)

~~(S)~~ A six-week study of Project COMBO and of the effects of bioacoustics on fleet operations concluded that both the U.S. and the Soviet Union would have the capability to apply bioacoustics to communications tasks after 1975 (reference 36). Covert active sonar using marine animal sounds requires changes in fleet sonar hardware and operating doctrine. Reliable, relatively covert communications possible through Project COMBO also will affect submarine tactical deployment.

~~(S)~~ Poor communications disrupt coordination in submarine escort or ASW operations. Even a limited covert communication ability will enhance coordination between surface ships and submarines. Project COMBO provides covertness unavailable with presently-deployed two-way communication systems and thus enhances coordination in critical scenarios.

~~(S)~~ U.S. Sonarmen typically tune out biologics as interference, but Soviet use of bioacoustics for communications is likely, so fleet sonarmen must become more familiar with bioacoustic signals. Past biologics classification was based on NASTAD training tapes, aural memory and the sonarmen's experience. Annotated BQR-20/22 displays and bioacoustic indices (reference 12) now augment the classification effort.

~~(S)~~ Marine animal sounds are ubiquitous (reference 37) and likely well-known to Soviet sonarmen. Signal processing techniques will aid and advance underwater military communications, but U.S. forces may face an increasingly costly race to stay below presumed detection thresholds. Covert communication by natural disguise is a psychologically confounding alternative approach that can convey considerable advantage to the adversary first employing the technique.

~~SECRET~~

~~SECRET~~

REFERENCES (U)

1. Cummings, W. C., R. L. Seeley, P. O. Thompson, S. J. Kennison. Unique Communications System (U). Patent Disclosure No. 59,978, 1975. ~~(SECRET)~~
2. Seeley, R. L., W. C. Cummings, S. J. Kennison. Communication Channel Fading Compensator (U). Patent Disclosure No. 58,979, 1975. ~~(SECRET)~~
3. Johnson, R.A., R. L. Seeley, W. C. Cummings, S. J. Kennison. Communications Error Correction Device (U). Patent Disclosure No. 58,980, 1975. ~~(SECRET)~~
4. Seeley, R. L., W. C. Cummings, S. J. Kennison. Synchronizer for Communication Initialization (U). Patent Disclosure No. 59,542, 1975. ~~(SECRET)~~
5. Ad Hoc Study Group. NSIA Ad Hoc Study Acoustic Communication Final Report (U). National Security Industrial Association, 1972. ~~(CONFIDENTIAL)~~
6. Howard, E. F. IACS/ORP Operational Feasibility and Effectiveness Study: Operator Coded Message Inputs (U). NUSC TM No. EAIX-C-15-74, 1974. ~~(CONFIDENTIAL)~~
7. Wrench, E. H. Jr. Increased Signal Processing Speed Using Sweep Limit Control (U). Unpublished NUC Report. (UNCLASSIFIED)
8. Thompson, P. O. and W. C. Cummings. Critical Survey of Certain Underwater Sound Transducers (U). Unpublished NUC Report. (UNCLASSIFIED)
9. Christian, J. Operating Characteristics of J15-3, HX-182, and HX-182 in HX-184 Hull Low-Frequency Transducers (U). Unpublished NUC Report, 1975. (UNCLASSIFIED)
10. Payne, R. S. and S. McVay. Songs of Humpback Whales. Science, 173:585-597, 1971.
11. Cummings, W. C., J. F. Fish and P. O. Thompson. Sound Production and Other Behavior of Southern Right Whales, *Eubalaena glacialis* (U). Transactions of the San Diego Society of Natural History 17(1): 13 pp, 1972.
12. Cummings, W. C. and P. O. Thompson. Sonarman's Guide to Biologies (U). NOSC TD 181, 77 pp, July 1978. ~~(CONFIDENTIAL)~~
13. Cummings, W. C. and P. O. Thompson. Sounds from Bryde's and Finback Whales in the Gulf of California (U). NOSC unpublished report, 26 pp. (UNCLASSIFIED)
14. Schevill, W. E., W. A. Watkins, and R. H. Backus. The 20-Cycle Signals and *Balaenoptera* (Fin Whales) (U). Marine Bio-Acoustics: Proceedings of a symposium held at the Lerner Marine Laboratory, Bimini, Bahamas, April 11-13, 1963. Macmillan Company, New York, 1964. (UNCLASSIFIED)

~~SECRET~~

15. Cummings, W. C. and P. O. Thompson. Underwater Sounds from the Blue Whale, *Balaenoptera musculus* (U). J. Acoust. Soc. Am. 50(4): 1193-1198, 1971.
16. Backus, R. and W. E. Schevill. *Physeter* Clicks (U). In Whales, Dolphins, and Porpoises, edited by K. S. Norris. University of California Press, Berkeley and Los Angeles, 1966.
17. Watkins, W. A. Acoustic Behavior of Sperm Whales (U). *Oceanus* (Woods Hole Oceanographic Institution), 20(2): 50-58, 1977.
18. Busnel, R. G. and A. Dziedziec. Acoustic Signals of the Pilot Whale *Globicephala melaena* and of the porpoises *Delphinus delphis* and *Phocoena phocoena* (U). In Whales, Dolphins, Porpoises, edited by K. S. Norris. University of California Press, Berkeley and Los Angeles, 1966.
19. Fish, J. F. and C. W. Turl. Acoustic Source Levels of Four Species of Small Whales. NUC TP 547, 14 p., December 1976. (UNCLASSIFIED)
20. Schevill, W. E. and W. A. Watkins. Whale and Porpoise Voices. A Phonograph Record. Woods Hole Oceanographic Institution. 24 p. phonograph disk, 1962.
21. Schevill, W. E. and W. A. Watkins. Sound Structure and Directionality in *Orcinus* (Killer Whale) (U). *Zoologica*, 51(6): 76-76, 1966.
22. Kooyman, unpublished recording of killer whale sounds in Antarctic. Scripps Institution of Oceanography.
23. Schevill, W. E. and B. Lawrence. Underwater Listening to the White Porpoise (*Delphinapterus leucas*) (U). *Science*, 109(2824): 143-144, 1949.
24. Evans, W. E. and J. H. Prescott. Observations of the Sound Production Capabilities of the Bottlenose Porpoise: A study of Whistles and Clicks (U). *Zoologica*, 47: 121-128, 1962.
25. Cummings and Thompson, unpublished recording of Pacific White-Sided Porpoise. (UNCLASSIFIED)
26. Schevill, W. E. and W. A. Watkins. Underwater Calls of *Leptonychotes* (Weddell Seal) (U). *Zoologica*, 50(1): 45-46, 1965.
27. Ray, C., W. A. Watkins, and J. J. Burns. The Underwater Song of *Erignathus* (Bearded Seal) (U). *Zoologica*, 54(2): 79-83, 1969.
28. Schevill, W. E., W. A. Watkins, and C. Ray. Underwater Sounds of Pinnipeds (U). *Science*, 141(3575): 50-53, 1963.
29. Watkins, W. A. and C. Ray. Underwater Sounds from Ribbon Seal, *Phoca (Histriophoca) fasciata* (U). *Fishery Bulletin*, 75(2): 450-453, 1977.

~~SECRET~~

30. Schusterman, R. J., R. Gentry, and J. Schmook. Underwater Sound Production by Captive California Sea Lions, *Zalophus californianus* (U). *Zoologica*, 52: 21-24, 1967.
31. Cummings, W. C. Project COMBO: Progress Report for Fiscal Year 1973 (U). Naval Undersea Center TN 1009, 22 pp, 1973. ~~(SECRET)~~
32. Cummings, W. C. Progress Memo, Project COMBO, 28 December 1973 (U). Naval Undersea Center Memo to D. G. Hoffman, NSHIPS PMS 3024, 17 pp. ~~(CONFIDENTIAL)~~
33. Urick, R. J. Principles of Underwater Sound for Engineers. McGraw-Hill, San Francisco, 342 pp, 1967. (UNCLASSIFIED)
33. Johnson, R. A. and A. W. Dibelka. Analysis and Synthesis of Natural Sounds (U). NUC TP 533, 36 pp, 1976. ~~(CONFIDENTIAL)~~
35. Bell, T. G. and G. C. Connally, Jr. Future Requirements for General Noise and Tonal Systems (GNATS) (U). NUSC TR 4613, 84 pp, 1973. ~~(SECRET)~~
36. Marich, M. NUC Memorandum, Ser 4013/WCC.S11/75. Report of Activity During Temporary Additional Duty (U), 15 pp, 1975. ~~(SECRET)~~
37. Cummings, W. C., W. T. Leapley, G. B. Farquhar, C. L. Brown, Jr., W. A. Friedl, A. L. Brooks. Bioacoustic Effects on Naval Operations: Report of Status and Recommendations (U). Naval Undersea Center TP 407, 30 pp, 1974. ~~(CONFIDENTIAL)~~

~~SECRET~~

~~SECRET~~

RELATED DOCUMENTS (U)

1. Cummings, W. C. Advanced System Concept for COMBO (U). Memo, COMNUC to COMNSHIPS, 0101-IPC:smm, 3900, Ser 0101-0010, 2 pp, 1971. ~~(SECRET)~~
2. Cummings, W. C. and J. F. Fish. Covert Communication Technique (U). NUC Memo to D. A. Wilson, NUC Code 04, 505 WCC:ejh, Ser 505-0012, 71, 5 pp, 1971. ~~(SECRET)~~
3. Cummings, W. C. Project COMBO Information. Response to Briefing to Dr. Helmeyer, DDRI (U). Memo COMNUC to COMNSHIPS (PMS 3024), 4 pp, 1973. ~~(CONFIDENTIAL)~~
4. Cummings, W. C. and J. F. Fish. Supplementary Information on Project COMBO (U). NUC Memo Report to NMAI 0315, CDR Donald Moyer, 5051 WCC:ah, 505-00234-73, 4 pp, 1973. ~~(SECRET)~~
5. Cummings, W. C. Advanced System Concept for COMBO (U). Memo COMNUC to COMNSHIPS (PMS-302), 0101-IPC:mc 5400, Ser 0101-005, 2 pp, 1973. ~~(SECRET)~~
6. Navy Scientific and Technical Intelligence Bulletin, ONI-Cp-17-5-73, 7 pp, 1973. ~~(SECRET)~~
7. Munson, J. C. Acoustic Communications for Mobile Platforms FY 75-77 Exploratory Development. A Study and Recommendations (U). Report to MOST Committee, NRI, 8100-82:JCM:jet, Enclosures, pp. 25, 26, 37-40, 42, A-2, A-6, A-7, 1974. ~~(SECRET)~~
8. Document OSI-W-S-30 74 (U), p. 3, 1974. ~~(SECRET)~~

~~SECRET~~