

AFM 181-4

30ct66

Proposed
Changes

AFM & AFL

181-4

(Superseded)

PROPOSED REVISION OF AFM 181-4,
MAINTENANCE OF CURRENT RECORDS

The subject content of the manual was rearranged to provide a logical pattern to follow in the various phases involved in maintaining records.

Guidelines were added to help eliminate unnecessary filing (such as creating the creation of documents to those that are essential) and to assist in selecting and arranging files space and equipment.

Basic types of records series are explained in more detail to permit easy recognition of those records to be filed in separate records series.

Instructions on files procedures have been expanded to facilitate or simplify labeling and using file folders and guides; preparing, filing, sorting, and filing papers; and files cut-off.

Equipment and supplies prescribed as standard for Air Force use have been expanded to include commonly used items. Control over requests for filing equipment has been extended to nonstandard filing supplies and additional criteria provided for powered or other mechanized filing equipment. (This includes the Presidential moratorium on the purchase of filing cabinets.)

Included are five illustration which are necessary for explanation plus 18 illustrations in the 1958 edition.

DEPARTMENT OF THE AIR FORCE
HEADQUARTERS UNITED STATES AIR FORCE
WASHINGTON, D 20330



REPLY TO
ATTN OF: AFDASB

15 Nov 1966

SUBJECT: Revised Procedures in AFM 181-4, 3 Oct 1966

TO: AAC (ALDAR)	ATC (AFCAS-C)	CINCPACAF (DASMR)	USAFSO (SFDASAR)
ADC (ADCAS-AR)	AU (AUDA-CR)	SAC (DASMR)	ACTIC (ACAP)
AFCS (CSDASFR)	CAC (DAS-MR)	TAC (DAMR-R)	USAFSS (CAS-4)
AFLC (MCGSAR)	HQ COMD USAF (ASR)	CINCUSAFE (DASR)	AFAFC (SAP)
AFSC (SCAR)	MAC (MADASR)	USAFA (DASR)	OAR (RRAMR)

1. We have received many inquiries concerning the provisions of the new AFM 181-4. Following is a discussion of some of the general and specific changes and the reasons for them.

2. General. The manual was written for the majority of recordkeepers of the Air Force. The provisions are based upon Government-wide standards prescribed by the General Services Administration. Some of the procedures and related terms that you have been familiar with have been changed or broadened to coincide with these standards. The procedures are mandatory unless the text of the specific procedure permits flexibility. Some procedures were purposely made flexible because of dissimilarities in recordkeeping practices due to variances in mission requirements, complexity of documentation, volume of files, capability of records clerks, and similar factors. We expect our records people at all levels to adjust these permissive procedures to cope with local problems and exigencies. Therefore, command records management officers should permit more freedom of action and the exercise of ingenuity in recordkeeping at the local level than was permitted in the past. We urge that you carefully consider the need for command-wide standardization of these permissive procedures before imposing arbitrary, mandatory practices on all recordkeeping activities.

3. Specific Procedures.

a. Offices of Record (Para 4). The requirement for commanders to designate offices of record was deleted. The guidelines to follow in establishing offices of record assures that such offices are properly located. The preparation of an AF Form 80 and the transmittal of a copy of that form to the records officer is sufficient notice of the designation and establishment of an office of record.

b. Subjective Arrangement (Para 8f and Item 6, Figure 3). Subjective arrangement is not restricted to the Air Force Subjective Classification System. The latter system is prescribed for the maintenance of correspondence and other related documents which cannot be filed in a more simple arrangement. The policy reference file, arranged by subject topic, is

one example of a locally devised "subjectively" arranged file of documents. Some of you prefer to identify this arrangement as "alphabetic by name" probably because (for demonstration of file coding purposes) the subjects are preceded by alphabetic symbols or because the subjects are arranged in alphabetical order. To achieve a more orderly arrangement, subjects are arranged in alphabetical order and then file codes are assigned--in the Air Force Subjective Classification System these are numerical file codes; in other subjectively arranged records series they are alphabetical file codes. Therefore, regardless of the file coding, the primary arrangement (determined by how the records will most often be requested) is by subject. Thus, the numerical file coding in the Air Force Subjective Classification System does not mean the primary arrangement is numerical; similarly, the alphabetic file coding in other subjectively arranged files does not mean the primary arrangement is alphabetical. We believe the designation is appropriate and should cause no confusion as long as local subjective categories are not assigned numerical codes similar to the Air Force Subjective Classification System.

c. File Coding (Para 10a(1) and 14a). The item number from the AF Form 80 may be used to code papers for filing in other than general correspondence files. While this was prescribed in the previous edition, question has been raised as to the necessity for coding large quantities of similar documents (bills of lading, special orders, etc.) if a command decides to make the procedure mandatory. Again, we believe this provision should remain flexible and not be imposed upon all offices of record. Certainly, an office that accumulates only one basic series (e.g., orders) need not place a file code (item number) on all orders to be filed. The procedure should be used only when it is necessary to segregate and identify several groups of documents for filing and refiling.

d. Placement of AF Forms 82 (Para 12a). The requirement that disposition guide cards be placed to indicate ultimate disposition of the related records was discarded because the system does not agree with Government-wide filing practices. Guide tabs should be placed on the left side (first position) of the file to introduce all records series. Center (second position) guide cards are used to introduce major subdivisions of each records series, when necessary. Right (third position) guides may be used to introduce further subdivisions. Since the guide card bearing the AF Form 82 also serves as the locator guide card introducing each records series, it is logical to place that guide only in the first (left) position. Furthermore, we found that records were not being destroyed or retired on the basis of the position of the disposition guide card but only after the AF Form 82 was referred to.

e. Describing Records in Column 5B of AF Form 80 (Para 10a(2)). The instructions for describing records on the AF Form 80 by using the paragraph title from AFM 181-5 has been changed to permit flexibility--the title of the applicable paragraph or subparagraph of AFM 181-5 will be

used when appropriate. The primary purposes of the change is to permit the AF Form 80 to describe more specifically the types of records in each office of record since many of the paragraph titles in AFM 181-5 are general descriptions of groups of documents. For example, Item 1 of Figure 3--the title of the subparagraph in AFM 181-5 (Files Maintenance and Disposition System Records) is not used because it does not specifically describe the records (AF Form 80) in the series.

f. Using Prong Fasteners (Para 13g and 17). The indiscriminate use of prong fasteners should continue to be discouraged. However, there are instances when their use is justified. When related papers cannot be stapled because of their thickness, the use of prong fasteners is preferred instead of rubber bands, paper and binder clips, pins, etc. Also, when entire folders are frequently used away from the files area, prong fasteners may be used to prevent the loss of loose papers within the folders.

FOR THE CHIEF OF STAFF



WILLIAM R. BOUCHER
Chief, Documentation Systems Division
Directorate of Administrative Services

May 10, 1967

GSA Regional Bulletin PPTR NO. 3-1-29
SUPPLY AND PROCUREMENTTO: Heads of Federal Agencies and Field Offices Located in
General Services Administration, Region 3

SUBJECT: Standardization of file folders and guide cards

1. Purpose. This bulletin advises agencies of the impending phase out of certain file folders and guide cards from the General Services Administration supply system as a result of recent standardization actions.

2. General. Standardization of file folders resulting from publication of Interim Federal Standard 00256 is shown on Attachment A. All special position cut tabs, plastic tabs and metal tabs have been eliminated and a straight cut, self tab substituted. A standard replacement is shown for these items to be retained as Military Supply Standard items. Standardizations of guide cards, resulting from publication of Federal Specification UU-C-95A is shown on Attachment B. The attachments do not include Department of Defense and Veterans Administration items not currently in the GSA supply system.

3. Action. Agencies should phase out existing stocks of deleted items. Requisitions submitted to Federal Supply Service will be canceled when present depot stocks are exhausted.

4. Expiration date. This bulletin expires upon publication of the 1967 GSA Stock Catalog and not later than December 31, 1967.

David Phillips
DAVID PHILLIPS
Regional Administrator

Distribution: R3A-5; 345A-X5; 38036

Attachment's

GSA REGIONAL BULLETIN FPMR NO. 1-E-29
 SUPPLY AND PROCUREMENT
 ATTACHMENT A

Current Federal Stock No.

- 7530-141-2484
- 200-4308***
- 222-3443*
- 251-6362
- 251-6363
- 251-6364
- 264-3645
- 269-9004
- 273-9845*
- 273-9846*
- 273-9847*
- 276-7909
- 281-2797
- 281-4445
- 281-4446
- 281-5905
- 281-5906
- 281-5907*
- 281-5908*
- 281-5938
- 281-5939
- 281-5940
- 281-5941
- 281-5942
- 281-5945
- 281-5959
- 281-5960
- 281-5961*
- 281-5962
- 281-5968
- 281-5969
- 281-5970
- 281-5979
- 281-5982
- 282-2507
- 282-2508*
- 282-7885
- 285-1732***
- 285-2816
- 285-2818
- 285-2824
- 285-2825
- 285-2826
- 285-5879
- 285-5899
- 286-1720
- 286-6923
- 286-6924*

Replacement Federal Stock No.

- 7530-663-0031
- Standard
- MSS** (889-8978)
- 7530-663-0031
- 663-0031
- 663-0031
- 926-8982
- 200-4308
- MSS** (889-3555)
- MSS** (291-0098)
- MSS** (926-8978)
- 7530-663-0031
- None - Note 1
- 285-1732
- 291-0098
- 926-8978
- 926-8980
- MSS** (926-8978)
- MSS** (926-8980)
- 200-4308
- 663-0031
- 200-4308
- 291-0098
- 285-1732
- 291-0098
- 663-0031
- 285-1732
- MSS** (00-23)
- 663-0031
- 926-8978
- 926-8978
- 926-8978
- 291-0098
- 200-4308
- 291-0098
- MSS** (285-1732)
- None - Delete
- Standard
- 291-0098
- 291-0098
- 291-0098
- 285-1732
- 285-1732
- None - Delete
- 663-0031
- 926-8981
- 926-8981
- MSS** (926-8982)

Kraft (Ltr)
Legal Broomage
Kraft (Legal)

Ltr of Broomage

Current Federal Stock No.

Replacement Federal Stock No.

286-6925
 286-6926
 286-6978
 286-7079
 286-7080
 286-7244
 286-7245
 286-7253
 286-7286*
 286-7287
 286-8570
 286-8571*
 286-8577
 290-2009
 291-0097
 291-0098***
 298-6906
 298-6907
 298-7047
 298-7048
 531-7809*
 559-4512***
 634-1785*
 634-5153
 634-5154
 634-5174
 643-4966
 656-1489*
 663-0031***
 707-8406**
 707-8415
 881-2957**
 881-2958
 881-2959
 881-2960
 889-3555**
 985-7012*
 990-8884

926-8981
 926-8982
 663-0031
 926-8981
 926-8982
 926-8981
 926-8982
 926-8981
 MSS** (926-8981)
 926-8982
 926-8981
 MSS** (926-8982)
 926-8982
 See Note 2
 291-0098
 Standard
 663-0031
 200-4308
 663-0031
 663-0031
 MSS** (285-1732)
 Standard
 MSS** (See Note 2)
 926-8982
 926-8982
 926-8981
 200-4308
 MSS** (None - Odd Size)
 Standard
 None - Retain
 None - Delete
 Standard
 926-8975
 926-8979
 926-8977
 Standard
 MSS** (200-4308)
 See Note 3

* These items are ~~not~~ Military Supply Standard items which will continue to be supported by GSA until final standardization action is published.

** These items are proposed replacements. They are published for information purposes only and may or may not replace the current standard item. The results of final selection between General Services Administration and Department of Defense will be included in future cataloging actions. (MSS 7530-7, September 30, 1966).

*** These items are ~~not~~ without charge.

Note 1. Folder ~~no~~ ~~new~~. FSI 881-3555 may be used as a substitute, without charge.

Note 2. Folder ~~no~~ ~~new~~ is listed as a "binder".

Note 3. List ~~no~~ ~~new~~.

GSA REGIONAL BULLETIN (FPMR NO. 1-1.2)
SUPPLY AND PROCUREMENT
ATTACHMENT B

Items Not Covered by Federal Specification
UU-C-95a To Be Discontinued

7530-988-6557
7530-988-6558
7530-988-6559
7530-988-6528
7530-988-6529
7530-988-6530
7530-988-6532
7530-988-6540
7530-988-6525
7530-988-6526
7530-988-6527
7530-988-6533
7530-988-6534
7530-988-6535
7530-989-0184
7530-989-2425
7530-988-9787
7530-988-9788
7530-286-7783
7530-269-8132
7530-205-0789
7530-205-0790
7530-233-6178
7530-233-6179
7530-233-6176
7530-233-6172
7530-233-6173
7530-233-6180
7530-285-1725
7530-285-1726
7530-285-1723
7530-285-1724
7530-264-5491
7530-261-3807
7530-261-3812
7530-261-3808

7530-249-5972
7530-261-3814
7530-269-9014
7530-269-9015
7530-269-9016
7530-269-9019
7530-261-3803
7530-261-3805
7530-281-2690
7530-264-5492
7530-261-3810
7530-261-3811
7530-285-1710
7530-261-3816
7530-261-3820
7530-261-3817
7530-285-1701
7530-285-1694
7530-261-3815
7530-285-1702
7530-285-1699
7530-285-1691
7530-285-1690
7530-261-3802
7530-285-1706
7530-285-3109
7530-285-3110
7530-285-3108
7530-285-1685
7530-989-0687
7530-989-0696
7530-989-0689
7530-989-0691
7530-989-0688
7530-989-0690
7530-988-6541

Items Covered by Fed.
Spec. UU-C-95a to be
Retained

7530-988-6542
7530-988-6543
7530-988-6549
7530-988-6550
7530-988-6551
7530-988-6544
7530-988-6545
7530-988-6546
7530-988-6547
7530-988-6548
7530-988-6515
7530-988-6516
7530-988-6520
7530-988-6521
7530-988-6517
7530-988-6518
7530-988-6522
7530-249-5969
7530-261-3813
7530-261-3804
7530-261-3801
7530-261-3819
7530-261-3818
7530-989-0698
7530-989-0697
7530-989-0692
7530-989-0694
7530-989-0693
7530-989-0695
7530-989-0683
7530-082-2635
7530-989-0684
7530-989-0686
7530-082-2646
7530-634-0004

Handwritten notes:
7530-989-0683
7530-082-2635
B
72, 16

Mullall

AFM 181-4

A I R F O R C E M A N U A L

RECORDS MANAGEMENT

**MAINTENANCE
OF
CURRENT RECORDS**

3 OCTOBER 1966

D E P A R T M E N T O F T H E A I R F O R C E

Records Management

MAINTENANCE OF CURRENT RECORDS

This manual prescribes policies, procedures, and techniques for maintaining current records. It explains how to establish basically uniform, economical, and efficient practices for maintaining all types of current records.

Contents

	Paragraph	Page
Chapter 1. Objectives and Responsibilities		
Why Records and Efficient Records Maintenance Practices are Necessary -----	1	1
Supplemental Publications -----	2	1
Duties and Responsibilities -----	3	1
Chapter 2. Planning and Arranging Files		
Where Records Are Located (Offices of Record) -----	4	3
Planning Files -----	5	4
Avoid Unnecessary Filing -----	6	4
Basic Types of Records Series -----	7	4
Basic Filing Arrangements -----	8	7
Air Force Subjective Classification System -----	9	11
Files Maintenance and Disposition Plan (AF Form 80) -----	10	14
Files Disposition Control Label (AF Form 82) -----	11	15
Chapter 3. Files Procedures		
Preparing and Using File Folders and Guide Cards -----	12	18
Preparing Documents for Filing -----	13	19
Classifying (Coding) Papers for Filing -----	14	19
Cross-References -----	15	19
Sorting Records -----	16	21
Filing Procedures -----	17	21
Labeling File Drawers -----	18	22
Using Charge-Out Records (AF Form 614/614A) -----	19	22
Filing Classified Records -----	20	22
Files Cutoff Procedures -----	21	23
Chapter 4. Filing Supplies and Equipment		
Objectives -----	22	24
Standard Filing Supplies -----	23	24
Standard Filing Equipment -----	24	24
Nonstandard Filing Equipment and Supplies -----	25	27
Procedures for Requesting and Controlling Filing Equipment and Nonstandard Filing Supplies -----	26	27
<hr/>		
This manual supersedes AFM 181-4, 20 February 1958, and AFL 181-4, 22 August 1966.		
OPR: AFDASB		
DISTRIBUTION: F; X: National Personnel Records Center (Military), 9700 Page Blvd, St. Louis, Mo. 63132 -----		
		25
St. Louis, Mo. 63132 -----		
		10
Federal Records Center, Cameron & Union Streets, Alexandria, Va. 22314 -----		

	Page
Figure	
1 Sample File Drawer -----	6
2 Alphabetical Divisions -----	10
3 Files Maintenance and Disposition Plan (AF Form 80) -----	16
4 Paper Authorized and Coded for File (With Cross-Reference Designation) -----	18
5 Cross-Reference Sheet, DD Form 334 -----	20
Attachment	
1 Air Force Subjective Classification System Master Outline -----	29

Chapter 1

OBJECTIVES AND RESPONSIBILITIES

1. Why Records and Efficient Records Maintenance Practices are Necessary. Records play a vital role in managing and operating Air Force activities. They serve as the memory of the organization, a record of past events, and the basis for future actions. Records maintained systematically will be complete, easily accessible, and properly arranged to serve current and future purposes. Eliminating duplicate and unnecessary records reduces the expense of handling and the cost and amount of supplies, equipment, and office space. Locating records properly within the organization allows full use and eliminates duplicating current records. Using the proper supplies and equipment further enhances the files operations. The following text contains procedures and criteria for attaining these goals.

2. Supplemental Publications. Command supplements to this manual or other publications that change the basic policies, procedures, or formats prescribed herein are prohibited. Forward a published copy of each major command supplement or other publication that implements this manual, with related forms, to HQ USAF (AFDASB).

3. Duties and Responsibilities.

a. *Records Management Officers*, appointed according to AFR 181-1, will:

(1) Exercise staff supervision over the program to insure that:

(a) The policies and procedures prescribed in this manual are complied with throughout the command, and

(b) Corrective action is taken when required.

(2) Coordinate and adjust command records maintenance practices to insure adequate documentation and to facilitate the disposition of records.

(3) Insure the full and economical use of equipment, supplies, and space for keeping records (see chapter 4).

b. *Records Officers*, appointed in accordance with AFR 181-1, are responsible for monitoring the program at their headquarters and its constituent elements. Reference to records officers in this manual includes those persons assigned the duties of a records officer on a part-time basis. Specifically, the records officer will serve as a consultant to records custodians and records clerks in carrying out the provisions of this manual. He will insure that all records are properly identified on AF Form 80, "Files Maintenance and Disposition Plan," so that correct disposition instructions are prescribed on AF Form 82, "Files Disposition Control Label." (See paragraphs 10 and 11). He will also review all requests for filing equipment to insure proper use in compliance with paragraph 26b.

c. *Records Custodians* are officials in charge of organizational elements which are "offices of record." (See paragraph 4.) They are also responsible for the adequate maintenance and appropriate disposition of the records and for the proper procurement and use of filing supplies and equipment in their custody (see paragraph 26a).

d. *Records Clerks* are individuals who have been assigned the duty of maintaining and servicing the files in an office of record. To do this job effectively, the records clerk must:

(1) Know the functions of the office for which the records are maintained.

(2) Know what purpose the records are to serve and adjust the filing practices accordingly, so that accurate and efficient reference service can be furnished the users of the file.

(3) Know and apply the records maintenance and disposition procedures applicable to the records he maintains.

(4) Consult with the records custodian and, when necessary, with the records officer regarding problems affecting the maintenance and disposition of records.

Chapter 2

PLANNING AND ARRANGING FILES

4. Where Records Are Located (Offices of Record). Records are located at organizational levels where effective documentation of assigned functions and responsibilities can be assured—offices that have primary interest in the subject matter documented by the records and the primary need to use the files. These locations are known as *offices of record*. Each office of record is responsible for the custody and maintenance of the permanent and temporary current records of the offices it serves. For example, an office responsible for a specific aspect of “administrative management” such as “records management” has custody of all documentation pertaining to that function. At that level, documentation and reference requirements can best be determined. Thus, the functions and responsibilities of the offices served by the office of record are segregated and completely documented—this makes the files more useful, improves documentation of functions, and facilitates disposition of the records. To insure conservation of personnel, equipment, and space; rapid and economical filing and reference; and protection of records, consider the following factors in physically locating records:

a. *Access.* Insure that records are sufficiently accessible to the using activities so that maintenance of duplicate files is unnecessary.

b. *Security.*

(1) Maintain classified files in approved security containers or in space approved as a secure room or alarmed area in accordance with AFR 205-1.

(2) Provide other supplemental safe-

guards required to adequately safeguard classified documents.

c. *Space:*

(1) *Adequacy.* Space should be adequate for present and anticipated records maintenance and service needs. To preclude filing and finding delays and low work output, consider the following in determining the proper amount of space required for files:

(a) The maximum quantity of records required to be maintained at one time; that is, the volume of records on hand at the end of the calendar (or fiscal) year plus the estimated accumulation of the next year.

(b) The minimum number of file containers required to house the records in (a) above. Floor space required for file containers is the space actually occupied by the file containers plus essential access and working (aisle) space. (An allowance of 6 square feet of space is normally adequate for a letter-size filing cabinet.)

(c) The minimum floor space required for necessary desks, chairs, tables, racks, storage cabinets, machines, etc., is based on the space actually occupied plus necessary access and working space.

(2) *Suitability.* Space should be suitable for requirements of the files operation. To insure efficiency of operation, files protection, and safety, health, and morale of records personnel, consider the following:

(a) Ventilation and heating should be comparable to that in other administrative-type working areas.

(b) Lighting should be comparable to that in normal office space—free from glare caused by sunlight, exposed bulbs, or distracting reflections.

(c) The floor should be strong enough to support the weight of the files, equipment, and personnel.

d. *Arrangement.* Arrange files equipment and supplies in collocation with files personnel to provide:

(1) Direct and smooth workflow with a minimum of travel, cross-movement, and backtracking.

(2) Placement of equipment as near as practicable to the most users.

(3) That the use of the records is appropriate to the work involved, e.g., classified records are located away from windows, doors, etc., to prevent unauthorized access.

5. Planning Files. The files of an office of record consist of one or more "records series." A "records series" is a group of documents with similar characteristics which is maintained apart from other groups of records in the office of record. The first planning step is to separate the records into series. This will reduce finding time by reducing the area of search.

a. When establishing records series, consider the following factors:

(1) Records have different retention requirements.

(2) A large group of records of the same kind serve the same purpose.

(3) Physical characteristics (nonstandard size and shape) preclude filing with standard size records—see paragraph 7g.

(4) Frequent, easy reference to a particular group of documents is necessary.

b. Following are examples of records more effectively maintained as separate records series:

(1) Record sets and reference collections of publications.

(2) Control type records, such as index cards, locator cards, mail control records, document receipts, etc.

(3) Records with short retention requirements such as locator files of messages and transitory and reading files.

(4) Case or project files, such as civilian and military individual personnel records and claims and contract case files.

(5) Specific series of records maintained as prescribed in a separate directive, i.e., numerical and functional forms, bills of lading, supply records, etc.

(6) General correspondence (subject) files.

(7) Nonstandard size records such as film, tape, disks, cards, and cartographic media.

6. Avoid Unnecessary Filing. In an efficient filing system, all unnecessary papers are *eliminated* before they are filed. Following are some of the means by which this is done:

a. Limit the creation of formal communications (i.e., use DD Form 95, "Memo Routing Slip," "short-note" replies, etc., whenever possible—see AFM 10-1).

b. Limit the number of copies of each document prepared to those which are specifically required or requested or which serve a valid purpose.

c. Eliminate file copies of routine communications which require no record—do not prepare file copies of:

(1) Each form and/or guide letter sent when a simple notation on the incoming communication will suffice—see AFM 10-1;

(2) Routine transmittals—see AFM 10-1; and

(3) Copies of letters furnished solely for information purposes unless it is *known* they will be subsequently referred to.

d. Limit "extra copy" files to those which prove efficient to those offices having sufficient justification for their maintenance.

e. Limit the technical reference material received and filed to that which will be of significant reference value.

7. Basic Types of Records Series.

a. *Related Documents Files.* Individual

documents or groups of documents performing the same function or reflecting similar or comparable transactions are filed together, e.g., bills of lading, requisitions, etc. They are usually filed by name or number and are terminated (cut off) either after a specified length of time or upon the occurrence of an event.

b. *Case Files.* These files are comparable to related documents files described above but reflect the "case history" of a transaction or document a series of related actions concerning a person, organization, location, product, or thing, e.g., contract case files, master personnel records, research and development project files, etc. Typically, a case file documents a transaction or relationship from beginning to end. Accordingly, they are terminated upon the occurrence of an event such as contact completion, retirement of an individual, or completion of a project.

c. *Case Working Papers.* These are short-lived correspondence and working papers accumulated in connection with specific case (project) files. They include background and working materials such as reference materials and data obtained for the case or project, data analyses and summaries, drafts, and other preliminary papers leading to final results or findings. The most common type of working papers are routine requests for reports or data on the case or project, routine correspondence concerning the administration of case or project, extra copies of documents or reference materials in the case file, etc. Although these papers should be segregated from the important case documents, they may be filed in the same case file folder but segregated within the folder. They may also be filed in separate folders and the folders placed together within the file drawer.

d. *Routine Transitory Records.* These are short-lived records that do not contain procedural or policy matter applicable to the receiving office. Transitory records:

- (1) Involve routine transactions;
- (2) Do not contain information of continuing reference value; and

(3) May consist of transmittal letters or forms; requests for routine information, publications, or supplies; communications correcting reports or other minor corrections to records; and/or documents not requiring action by the receiving office.

The recognition and separate maintenance of transitory material is important. Immediately destroy transitory material which has served its purpose rather than file it. Elimination of this material simplifies filing and disposition—there are fewer papers to code, sort and file; reference to important papers is easier and faster; and the need to "screen" records at time of disposal is eliminated. Chronologically maintain as a separate records series that material to be of reference value for 90 days or less. If the volume warrants using more than one folder, four folders may be used as illustrated in figure 1 (item 3). Use one folder each month. At the beginning of each month, place the folder used the previous month behind the other three folders until all four folders have been used. At the beginning of the fifth month, destroy the contents of the folder in front and reuse the folder for that month, etc.

e. *General Correspondence (Subject) Files.* Each office of record will normally have a separate correspondence file. This file consists of originals and copies of communications, memoranda, and related attachments. This correspondence invariably involves a wide variety of subjects and as a consequence can best be identified and used if arranged by subject. The prescribed system for the subject arrangement of Air Force correspondence is the Air Force Subjective Classification System found in paragraph 9 and attachment 1.

f. *Technical Reference Materials.* These materials may include copies of publications, special reports and/or studies, periodicals, etc., required by the accumulating office as a "technical reference library." These materials should be evaluated and only those which are current and will be of significant reference value should be filed. They are usually maintained by offices such as those involved in

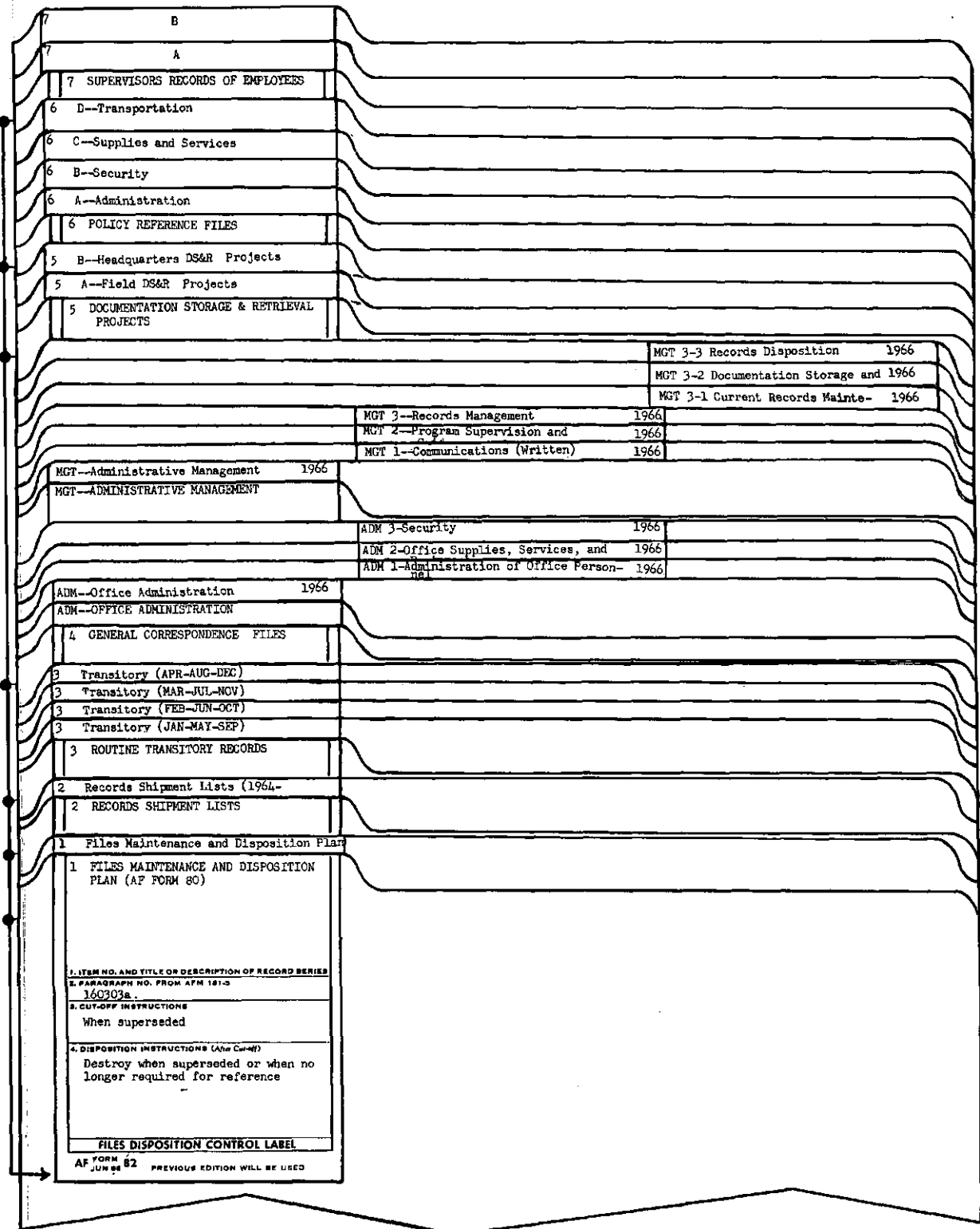

Figure 1. Sample File Drawer.

statistical reporting, research, development, and gathering and disseminating information.

g. Extra Copy (Convenience) Files. These are extra copy files of documents created or received by an office in addition to those filed in other established records series, i.e., copies maintained only for convenience of reference. They should not be maintained by offices unless there is sufficient justification for their use.

(1) *Reading Files.* These are copies of outgoing communications (letters, messages, etc.) or other documents maintained for ready reference, signature control, preparation of periodic activity reports, or similar routine administrative reasons. (See paragraph 4-5, AFR 205-1D, 5 May 1965.)

(2) *Policy Reference Files.* These are copies of selected documents reflecting policies, precedents, procedures, and instructions governing the performance of the mission and operation of the office. They are used as a ready reference in conducting daily business and as a means of indoctrinating new personnel. The file is kept current on a continuing basis by replacing superseded documents, removing obsolete documents, and adding new documents.

h. Nonstandard Size Records. Nonstandard size records such as card files, large maps and charts, roll of film, tape recordings, etc., are filed separately when their size and shape preclude filing with standard size records. They may include:

(1) *Still Pictures* — occasionally received prints may be filed with the regular files whereas the negatives require special housing and care for preservation.

(2) *Sound Recordings*—some disks can be filed with standard size records whereas even a small volume of tapes must be filed separately.

(3) *Magnetic and Paper Tapes, X-ray Films, and Microphotographs.*

(4) *Aerial Photographs.*

(5) *Engineering Drawings* — may be blueprints, diazo prints, pencil sketches, or

tracings on vellum which require special reproduction equipment. Some oversize maps and drawings can be folded and filed with related papers in the regular files. However, too many bulky folded papers seriously hampers filing and reference in standard size records. If more than 10 percent are oversize, file them separately.

(6) *Punched, Microprinted, and Microfilm Aperture Cards.*

8. Basic Filing Arrangements. After determining which records will be filed as separate records series, select a method of arranging each series. The selected arrangement should permit ease of filing and finding and preclude the use of separate indexing systems, whenever possible. Frequently, filing procedures for a specific series of records are provided in the directive which prescribes the records. However, when records are accumulated for which specific filing instructions are not prescribed, select one of the following arrangements for the records based upon the feature by which the records will most often be requested. Within the basic arrangement selected for the records series, one or more of these arrangements can be used for further breakdown or subdivision of the series. For example, records geographically arranged may be further arranged by organization; records filed by subject are further arranged chronologically. See paragraph 26a(3) for obtaining approval of patented filing and indexing systems.

NOTE: The office requiring the creation of specific records may prescribe the filing system for the records providing they follow these basic arrangements. If the system is rather common, it will be included in this manual.

a. Numerical Arrangement. This system is used to arrange records normally identified and referred to by number, such as bills of lading, requisitions, purchase orders, etc. Other records, such as accounting documents are more useful when arranged by allotment number. (*NOTE:* As a general rule, with the exception of subject codes, do not assign numbers to documents for the sole purpose of arrangement for filing. This practice re-

quires the establishment of additional indexes to locate the documents.) The two most common methods of arranging files by number are discussed below.

(1) *Consecutive Numerical Sequence.* This is the conventional method of numerically arranging files—the numbers are arranged by their normal sequence, e.g., 1, 2, 3, 4, etc.

(2) *Terminal Digit Method.* Using this method, the digits (in groups of 2 or 3) are read from right to left. They are arranged first by the last two or three digits (primary group), then by secondary group, etc. The following example of "123456" illustrates the difference between the consecutive sequence and the terminal digit methods.

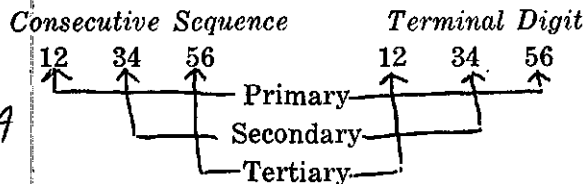

NOTE: Consider using the terminal digit method when documents to be numerically filed have gaps in their numerical sequence, have 5 or more digits, and consist of 25,000 cards or papers or 10,000 case folders. This system speeds sorting and filing, reduces errors caused by transposition of numbers, and permits better workload distribution.

b. *Chronological Arrangement.* This system is used to arrange files in date sequence when the date is the primary means of reference. It is the most useful method for keeping documents in small, manageable groups, usually by year, month, and day. Chronological arrangement is frequently used in conjunction with other arrangements. Transitory, reading, and suspense files are examples of records which are arranged by date.

c. *Geographical Arrangement.* In this arrangement, papers are filed by geographical location such as area, country, state, county, etc. It is used when the geographical location is the primary means of reference. Files are arranged in alphabetical sequence first by the name of the main geographical division, such as a state, then by the next most important subdivision required for reference such as counties, cities, or names of bases.

d. *Organizational Arrangement.* This arrangement is used when the grouping of documents by the name of the pertinent organization is the primary means of reference. Organizational arrangement is fundamentally an alphabetical arrangement of organizations as they relate to each other. They are arranged by particular levels of command and subdivided by subordinate elements arranged alphabetically and numerically by the organizational designations. If both name and number organizational designations are filed in the same group, file the names in front of the numbers.

e. *Alphabetical Arrangement.* This arrangement is used to file documents by name of persons, companies, agencies, etc., in alphabetical sequence. In arranging papers alphabetically, disregard articles, conjunctions, and prepositions but inclose them in parentheses. Apostrophe s ('s) does not affect filing arrangement; however, s apostrophe (s') does. Specific rules follow:

(1) *Surnames*—arrange by names of individuals in alphabetical sequence first by surname, then first name or initial, and then by middle name or initial. In filing, disregard titles such as Jr., Sr., Dr., etc., but inclose them in parentheses following the name.

Example: Allen, A.
Allen, A. B. (Capt.)
Allen, A. B. (Dr.)
Allen, Alice

(2) *Hyphenated and Prefixed Surnames*—arrange as one word.

Example: Dalton Page, A. D.
D'Arcy Page-Lewis, S. M.
Dawes Pagella, T. M.
MacGinty Van Burgund
M'Ginty Vancourtland

(3) *Abbreviations and Names containing Numerals*—arrange as though spelled out.

Example: Assn ----- Association
Mt ----- Mountain
19th ----- Nineteenth
St ----- Saint
10th ----- Tenth

(4) *Names Consisting of Initials (Trade or Coined Names of Firms)*—arrange as one word.

Example: OAR Chemical Company
OAX Radio Station
PDQ Messenger Service

(5) *Names Containing Words Denoting Direction*—arrange as one word.

Example: South East -----Southeast
West Side -----Westside

(6) *Names of Institutions, Schools, and Colleges Containing an Individual's Name*—arrange by first name. (This does not apply to companies and other business organizations.)

Example: Georgetown Hospital
George Washington University
John Hopkins University

(7) *Organizational Titles Containing Names of Individuals*—arrange first by surname of the first individual mentioned.

Example: Charles Brown and Henry Jones
Brown, Charles (and Henry Jones)
Charles Brown and Company
Brown, Charles (and) Company

(8) *Compound Geographical or Location Words*—arrange as written.

Example: Fort Monmouth Supply Company
Newark Provision Company
West Virginia Grocery Company
West Wellington Motors

(9) *Identical Firm Names*—arrange first by firm name and then by location.

Example: Brown & Company, Denver, Colo
Brown & Company, Los Angeles, Calif
Republic Aviation Corporation, Denver, Colo
Republic Aviation Corporation, San Francisco, Calif

(10) *Chambers of Commerce, Boards of Trade, Banks, Newspapers, etc.*, for which the city is the identifying word—arrange first by city with the state in parentheses and then by name of the chamber of commerce, etc.

Example: Chamber of Commerce, Wash DC
Washington (DC) Chamber
(of) Commerce

(11) *Federal Departments and Subdivisions*—arrange by name disregarding the parent organization.

Example: Department of the Air Force
Air Force, Dept (of the)
Executive Office of the
President—President, Executive
Office (of the)

(12) *State, County, Municipal, or Foreign Government Offices* (such as departments, boards, bureaus, etc.)—arrange first by name of state, county, etc., then by name of department.

Example: Police Department, Arlington
County, Va.
Arlington County (Va) Police
(Dept)

(13) *Nongovernment Firms With Names Beginning With "State, City, County, Board of, Bureau of," etc.*—arrange as written.

Example: City Office Supply Company
Committee (for) Hospitality

(14) *Firms Operating Under More Than One Name and Firms With a New Name*—arrange by most active or current name, as applicable, and cross-reference other appropriate names.

(15) *Fraternal and Similar Organizations When Part of a Larger Organization*—arrange first by name and then by parent organization.

Example: American Legion, Arlington Post, Va.
Arlington (Va.) Post, American Legion

(16) *Indexing the Alphabetical File.* Indexing an alphabetical file is accomplished by placing guides to indicate the various divisions and subdivisions of the alphabet under which each group of names falls. The number of alphabetical subdivisions used in a file depends upon the number of names

15 Div.		25 Div.		60 Division							
A	M	A	J	Q	A	Co	Gi	Ki	Mu	Ro	U
B	N	B	K	R	Am	Cr	Gr	L	N	S	V
C	P	C	L	S	B	D	H	Le	O	Se	W
D	R	D	M	T	Be	De	He	Li	P	Sch	We
F	S	E	Mc	U	Bi	Do	Ho	M	Pe	Si	Wi
H	T	F	N	V	Br	E	Hu	Mar	Pi	St	XYZ
I	W	G	O	W	Bu	F	I	Mc	Q	Su	
K		H	P	XYZ	C	Fi	J	Me	R	T	
		I			Ch	G	K	Mo	Ri	To	

100 Division										
A	Bo	Cor	Et	H	J	M	P	Se	Tr	
Al	Br	Cr	F	Ham	John	Man	Pe	Sh	U	
Am	Bro	Cu	Fi	Har	K	McA	Pi	Si	V	
Ander	Bu	D	Fo	Hat	Ke	Me	Pr	Smith	W	
Ar	C	De	Fr	He	Ki	Mi	Q-R	Sp	War	
B	Car	Di	G	Hi	Kn	Mo	Ri	St	We	
Bar	Ch	Do	Ge	Ho	K	Mu	Ro	Sto	Wh	
Be	Cl	Dow	Go	Hon	Le	N	Ros	T	Wi	
Ber	Co	E	Gr	Hu	Li	Ni	S	Tho	Wo	
Bi	Con	El	Gro	I	Lo	O	Sch	Ti	XYZ	

150 Division										
A	Br	Cu	Fl	Har	Jones	Man	P	Se	V	
Al	Bro	D	Fo	Harr	K	Mas	Pe	Sh	Ve	
Am	Bu	Davis	Fr	Hat	Ke	McA	Pet	Si	W	
Ander	Bur	De	Fri	He	Kel	McD	Pi	Smith	Wall	
Ar	C	Del	G	Hen	Ki	McK	Pr	Sn	War	
At	Car	Di	Gar	Her	Kn	Me	Pu	Sp	We	
B	Cas	Do	Ge	Hi	Kr	Mi	Q-R	St	Wei	
Baker	Ch	Dow	Gi	Ho	L	Miller	Re	Sto	Wh	
Bar	Che	Du	Go	Hol	Lar	Mo	Ri	Su	Wi	
Be	Cl	E	Gr	Hon	Le	Mor	Ro	T	Williams	
Ber	Co	El	Gre	Hu	Lei	Mu	Ros	Te	Wilson	
Bi	Con	Et	Gro	Hun	Li	N	Ru	Tho	Wo	
Bl	Coo	F	H	I	Lo	Ni	S	Ti	Wr	
Bo	Cor	Fe	Hal	J	Lu	O	Sch	Tr	XY	
Bon	Cr	Fi	Ham	John	M	Or	Schm	U	Z	

Figure 2. Alphabetical Divisions.

in the file and whether the materials to be filed by name are individual papers, cards, case files, etc. As a general rule, provide an alphabetical subdivision guide for each 10 to 20 name folders, or for each 25 to 50 name cards. Standard sets of alphabetical subdivision guides are available in a wide

variety of numbers of subdivisions. When such guides are procured, specify "non-terminal" alphabetical subdivisions, such as those illustrated in figure 2. Use the number of guides that makes searching the files easiest, but remember that too many guides defeat their purpose.

f. *Subjective Arrangement.* This arrangement is used when the grouping of documents by subject is the primary means of reference. The subjective arrangement of general correspondence files (see paragraph 7e) has been standardized Air Force-wide (see paragraph 9). This standardized arrangement is known as the Air Force Subjective Classification System.

9. Air Force Subjective Classification System.

This system has been designed to arrange and group correspondence and other related papers described in paragraph 7e by the function to which their subject pertains. *Exception:* Small groups (less than 10 papers) of documents with a retention period of 1 year or less may be filed in the "ADM—Office Administration" portion of correspondence files created at major subordinate command level and above and in all correspondence files at lower levels when such action facilitates reference and simplifies disposition.

a. *Major Subjective Categories.* All of the functions performed by Air Force activities have been grouped into 25 broad categories which are referred to as "major categories." A list and description of each major category follows:

(1) ADM—OFFICE ADMINISTRATION. This category is established for classifying and grouping all documents accumulated in carrying out the *internal* administration or "housekeeping" activities of the office, as distinguished from those documents that are incident to the primary mission. For example, this category will consist of:

(a) Correspondence pertaining to the administration of personnel assigned to the office.

(b) Records pertaining to charity campaigns.

(c) Local mail handling and control.

(d) Local security records.

Thus, this category serves as a convenient means for segregating all nonmission correspondence and related paper which should be

retained for one year at all levels of the organization—see Chapters 5 and 6, AFM 181-5.

(2) CIV—CIVILIAN PERSONNEL ADMINISTRATION. This category includes subjects relating to the functions affecting civilian personnel including classification; pay administration; recruitment, employment, placement, and separation of civilian employees; employee-management relations and necessary employee services; career development of civilian employees; participation in the programs of the Board of U.S. Civil Service Examiners; and promotion and administration of the Air Force employee incentive programs. All subjects pertaining to civilian pay operations are correlated under FINANCIAL ADMINISTRATION. All subjects pertaining to civilian training are correlated under TRAINING except those concerning the career development program.

(3) COM—COMMAND CONTROL AND COMMUNICATIONS. The subjects in this category relate to the management, concept of operations, system processing, and individual systems/progress for all Air Force command and control matters. It also includes subjects relating to the establishment, maintenance, and operation of facilities for the electrical transmission of communications, fixed radio, wire facilities, and frequency management.

(4) ENV—AEROSPACE ENVIRONMENT. This category includes subjects concerning the total aerospace environment, such as weather forecasting and observing, related meteorological activities and services, solar observing and forecasting, solar-terrestrial effects, and related aerospace environmental activities and services.

(5) FIN—FINANCIAL ADMINISTRATION. This category includes subjects relating to the disbursement, collection, and accounting for public funds; the operation of the appropriation, expenses, cost, monetary property, and international accounting system; auditing for Air Force and industrial accounts; budgeting; civilian payroll operations and subjects relating to nonappropri-

ated funds, surety bonds, and reports of survey.

(6) INF—INFORMATION ACTIVITIES. This category includes subjects involved in the internal and public information program. It also includes subjects relating to external relations such as international organizations and legislative activities.

(7) INS—INSTALLATIONS MANAGEMENT. This category relates to the construction, maintenance, and operation of facilities including land, buildings, other fixed structures and their appurtenances; family housing; and the related engineering planning programs.

(8) INT—INTELLIGENCE. The subjects in this category concern the collection, analysis, exploitation, and dissemination of intelligence information of military value.

(9) INV—INVESTIGATIONS, INSPECTIONS, AND SAFETY. The subjects in this category relate to the investigations, inspections, and safety systems. They reflect the adequacy and preparedness of the Air Force to accomplish its assigned mission; the state of training readiness, discipline, morale, health, and welfare of units and individuals; ground, flight, nuclear, missile, and explosive safety; and matters involving crime, other violations of public trust, and subversive and related activities within the Air Force.

(10) LEG—LEGAL ADMINISTRATION. This category includes subjects relating to administration of military justice, processing claims, legal assistance for military personnel and dependents; legal opinions and interpretations; patents; and taxation. The Index in the "Digest of Opinions—The Judge Advocates General of the Armed Forces" may be used as a guide for subdividing "legal opinions and interpretations," as required. Documents involving the rendering of an opinion, if accumulated by other than legal offices, should be classified according to the subject matter of the opinion.

(11) MAP—MAPPING AND CHARTING. This category relates to the development, collection, computation, production,

and distribution of cartographic photography, gravimetric, geodetic, intelligence, and other records. These records pertain to Air Force activities engaged in mapping, charting, cartographic aerial photography, aerial electronic surveying, and geodetic and gravimetric surveying.

(12) MED — MEDICAL SERVICES. This category includes subjects concerning the general medical and health status of Air Force personnel; hospital and dispensary administration; professional services and clinics; and veterinary services.

(13) MGT — ADMINISTRATIVE MANAGEMENT. This category is used to group functions, techniques, and activities relating to the general field of management as distinguished from specific management functions. (Specific management functions are covered by other major subjects categories.) Some of the subjects included in this category are documentation and records management; management planning and improvement; histories; postal operations; data and reports management; and organization of Air Force units.

(14) MIL—MILITARY PERSONNEL ADMINISTRATION. This category relates to the administration of military personnel and their pay, welfare, recreation, and morale. It also includes chaplain functions. Subjects dealing with the training of military personnel are found under the "TRAINING" major subjective category. Correspondence and other documents pertaining to the service career of an individual should be filed in the individual's Field Record Group or the Command Personnel Record Group, as appropriate, rather than in a subject file.

(15) MTN — MATERIEL MAINTENANCE ENGINEERING. This category involves preventive maintenance; servicing; repair; modification; and related subjects involving the maintenance of materiel.

(16) OPS—OPERATION. This category refers to military air operations which involve the preparation for and conduct of air warfare. Flight operations during peace

and war are included. Peacetime operations also include subjects relating to maneuvers, flights, exercises, war games, and related activities. Be sure to distinguish between the type of operations above and the subject matter of other unrelated activities which are designated "operations" in a general sense. Such subjects should be classified under the appropriate major subjective category.

(17) PHO—PHOTOGRAPHY. This category includes subjects relating to aerial photography, motion picture and still photography, sound recording, and related photographic activities.

(18) POL—POLICE OPERATIONS. This category relates to the enforcement of law and order; the confinement, retraining, and restoration of prisoners; and related activities of directors of security and law enforcement except "military security" which is established as a separate major subjective category.

(19) PRO—PROCUREMENT. This category relates to the procurement of materiel and services from sources outside the Air Force by contract, purchase, and other negotiations. It includes such related matters as industrial resources, production planning, and quality control.

(20) PUB—PUBLISHING AND PUBLICATIONS. This category covers subjects concerning the preparation, printing, and distribution of publications, forms, and orders. Record and reference sets of publications are not to be filed in this category—they are filed as separate series of records.

(21) R&D—RESEARCH AND DEVELOPMENT. This category includes subjects representing areas and objectives of research and development. The subdivisions of this category are grouped to meet research and development requirements and are based on technical groupings.

(22) SEC—SECURITY. This category is intended to cover the responsibilities and activities of maintaining the National security, and particularly the safeguarding of classified information.

(23) SUP—SUPPLY AND SERVICES. This category involves subjects dealing with the storage, distribution, handling, and cataloging of supplies; and furnishing laundry, commissary, and other services.

(24) TNG—TRAINING. This category concerns the training of military and civilian personnel and the education of dependents in the United States and foreign countries. Subjects concerning the training of civilians as part of the career development program may be subdivided under "CIV (Career Development)." It includes subjects involved in the various types of training that are conducted, as well as those concerning the Air Academy, reserve activities, foreign trainees, and colleges and universities.

(25) TRS—TRANSPORTATION. This category concerns the movement of cargo, personal property, and passengers by commercial and military land, air, and water transportation.

b. Subdivisions. Each of the major categories described above is subdivided by related subject matter. These subdivisions are referred to as primary, secondary, tertiary, and quaternary subjects or topics. The complete list of subjects is referred to as the master outline.

c. Master Outline. The master outline in attachment 1 is intended only as a reference guide in establishing a subjective file to meet the specific requirements of the user. Subjects not specifically provided in the master outline may be added. Secondary and further topics may be used as primary topics when they represent the primary functions of the office of record. Note that the subjects in the master outline refer to correspondence or other documents relating to the subject rather than to the record itself, i.e., reference to "military personnel records" in "MIL" relates to correspondence on that subject rather than to the personnel record itself. Following are specific rules for using the master outline:

(1) Use the master outline as the basis for establishing a file—*use only that part of*

the outline that meets your needs and add new subjects as needed. Select the major categories that represent your subject matter and use a minimum of subdivisions. (Generally, two major categories will be used by an office of record, i.e., "Office Administration—ADM" and the major category representing the mission and responsibilities of the office.) For example, if only a small volume of records is accumulated under a major category, use only the major category as a file title and, if necessary, selected primary subjects.

(2) Add new subjects (topics) only when experience indicates reference rate and volume of documents warrant a separate subdivision.

(3) When numbering primary, secondary, and other subjects, assign your own numbers in sequence under each major category, as illustrated below.

MIL 1 Assignment and Reassignment
 1-1 Permanent Change of Station
 1-2 Temporary Duty
 1-2-1 CONUS
 1-2-2 Overseas

(4) Avoid setting up folders that will contain only one or two papers. Subdivide major and primary subjects only when reference rate or volume warrants.

d. *File Outline.* After choosing the appropriate major categories and subordinate subjects, prepare a file outline as part of AF Form 80, described in paragraph 10 below. Also, see figure 3 for examples.

e. *File Coding.* See paragraph 14 for detailed instructions on file coding. In the Air Force Subjective Classification System, file codes consist of a combination of letters and numbers representing a particular subject. Subjects are assigned file codes to facilitate classifying, sorting, and filing. The coding system consists of a three letter symbol (short title) for each major category and numbers representing the subdivisions. Dashes are used to separate the numbers. An example of file codes under this system follows:

Major Category: CIV
 Primary Subject: CIV 1
 Secondary Subject: CIV 1-1
 Tertiary Subject: CIV 1-1-1

10. Files Maintenance and Disposition Plan (AF Form 80). Now that the files have been properly placed in offices of record, records series identified, and the appropriate filing arrangement selected for each series, each office of record must prepare AF Form 80. This plan identifies all records for which an office has responsibility—both general correspondence files and other records series. When used with AF Forms 82 described in paragraph 11 below, this form provides a comprehensive and efficient system for maintaining and disposing of records.

a. *Preparation.* Prepare AF Form 80, in duplicate, using both sides.

(NOTE: Items 1 through 4 are self-explanatory except that both the office symbol and unit designation may be entered in Item 1.)

(1) *Column 5A.* Start with number "1" and consecutively number each series of records on the "Plan."

(NOTE: When the volume justifies, this item number may be used to code papers for filing in series other than correspondence files—see paragraph 14.)

(2) *Column 5B.* Enter a brief, precise description of each series of records, using title of the applicable paragraph or subparagraph of AFM 181-5 when appropriate. If necessary for series identification, list various documents in the series. For records series other than ^{GENERAL CORRESPONDENCE} subjectively arranged files, the subdivisions may be assigned letters for ease of identification, coding, and filing (see Item No. 6 of figure 3). A

(NOTE: If a group of records is not identified in AFM 181-5, use a brief title that describes the file and its function.)

When records are maintained apart from the majority of files of an office of record, enter their location beneath the pertinent records group. When records are not maintained in filing equipment, also enter disposition instructions. When identifying general cor-

correspondence files accumulated at major subordinate commands and levels above, list the "mission" and "office administration" portions of the file as separate items. At all other levels, list general correspondence files as one item. Then, list specific subjects making up each portion of the file (see figure 3 and paragraph 9.) List records series in the sequence that best suits the needs of the using office. Use unclassified descriptions or if the subject/title/description is classified, use abbreviated or short titles by using the first letter of all words except articles, prepositions, or conjunctions which may be spelled out. For example, "Accountability Records for Classified Documents (S)" would be identified as "AR for CD (S)."

(3) *Column 5C.* Self-explanatory.

(4) *Column 5D.* Enter paragraph and subparagraph numbers of AFM 181-5 prescribing disposition of the records. If a paragraph covering disposition of the files cannot be found, enter "None" and advise the records officer.

b. *Distribution.* The office of record retains AF Form 80 (original). Forward the copy to the responsible records officer for review and use in monitoring the maintenance and disposition of the records concerned.

c. *Review.* Preparing AF Form 80 is a one-time job. However, periodically review and amend the form to insure that all files are accounted for and that cited disposition authorities are appropriate. Notify records officers of any corrections, deletions, or additions. Reaccomplish AF Form 80 only when further corrections or additions cannot be made.

d. *Standardization.* Some lower echelon activities (such as base exchange units) accumulate, maintain, and dispose of like records in the same way. In such cases, standardization of AF Form 80 will save time and money. The records management officer approves proposed standard AF Forms 80 before using activities prepare and distribute them.

11. Files Disposition Control Label (AF Form 82). After AF Form 80 is prepared, the next step is to prepare Files Disposition Control Labels (AF Forms 82)—see figure 1—for each records series listed on AF Form 80.

a. *Preparation:*

(1) *Item 1 (Item Number and Title or Description of Records Series).* Enter information from Columns 5A and 5B of AF Form 80.

(2) *Item 2 (Paragraph Number from AFM 181-5).* Enter applicable information from Column 5D of AF Form 80.

(3) *Item 3 (Cut-Off Instructions).* Indicate day and month (omit year to permit reuse of disposition guide card) or event when records will be cut off as prescribed in paragraph 21.

(4) *Item 4 (Disposition Instructions (After Cut-Off)).* Enter the following information, as appropriate:

(a) If the records series has a short retention period and can be held in available space and equipment in office of record until eligible for destruction, enter the word "Destroy" followed by the retention period, e.g., "Destroy after 6 months."

(b) If the series is "permanent" or subject to a long retention period, enter the words "Retire to Staging Area" or "Retire to Records Center," as appropriate, followed by the period of retention in the office of record, e.g., "Retire to Staging Area after 2 years." If the records are permanent, so indicate; if the records are temporary, give additional retention period, e.g., "Destroy after 3 additional years." If disposition instructions are too lengthy for inclusion in this block, enter "See AFM 181-5."

(c) If no disposition instructions have been published, enter "None." If instructions are published later, cross out "None" and enter applicable instructions.

NOTE: When AF Form 82, Aug 61, is used, enter "after cut-off" after appropriate disposition instructions.

b. *Use.* AF Form 82 is printed on special

FILES MAINTENANCE AND DISPOSITION PLAN		DATE PREPARED	
1. OFFICE SYMBOL OF OFFICE OF RECORD OR UNIT DESIGNATION		2. PREPARED BY (Name of records clerk)	
3. TYPED NAME AND POSITION TITLE OF RECORDS CUSTODIAN		4. SIGNATURE OF CUSTODIAN	
5. FILES PLAN			
ITEM NO.	TITLE OR DESCRIPTION OF RECORDS SERIES	FILING ARRANGEMENT OF EACH SERIES (Subjectively, numerically, alphabetically, etc.)	DISPOSITION (Insert number of paragraph and sub-paragraph in AFM 181-5. If paragraph cannot be found, enter "None.")
1	Files Maintenance and Disposition Plan, AF Form 80		160303a
2	Records Shipment Lists	Chronological	160303b
3	Routine Transitory Records	Chronological	050102
4	General Correspondence Files	Subjective	050101b
	ADM--Office Administration		
	1 Administration of Office Personnel		
	2 Office Supplies, Services, and Equipment		
	3 Security		
	MGT--Administrative Management		
	1 Communications (Written)		
	2 Program Supervision and Guidance		
	3 Records Management		
	3-1 Current Records Maintenance		
	3-2 Documentation Storage & Retrieval Systems (See Item No. 5 for DS&R Projects)		
	3-3 Records Disposition		
5	Documentation Storage and Retrieval Projects	Organizational	160303d
6	Policy Reference Files	Subjective	050202
	A--Administration		
	B--Security		
	C--Supplies and Services		
	D--Transportation		
7	Supervisor's Records of Employees	Alphabetical	070302
8	Position Description Files	Numerical	070303
9	Security Clearance Summary Records	Alphabetical	260110
10	Access Authorization Certificates	Alphabetical	260109b
11	Registered Dispatch Receipts	Chronological	060201c
12	Accountability Records for Classified Documents	Chronological	260104
13	Room and Safe Security Control Records (At each main exit and on each safe)(Destroy when superseding records are prepared)		260111a
14	Reading Files	Chronological	050103
15	Suspense Records	Chronological	060202c

AF FORM 80
Aug 61

Figure 3

paper stock which adheres to file guide cards when moistened with water. Affix this form to tabs of guide cards preceding each records series. When placed on guide cards, these labels identify records filed behind each disposition guide card and prescribe their ultimate disposition in accordance with authorities from AFM 181-5 cited on AF Form 80. It is important that all records following a disposition guide card have the same retention period except as indicated in paragraph 9. These guide cards and labels are "disposition" guide cards as distinguished from "locator" guide cards described in paragraph 12a. (Do not use both "locator" and "disposition" guide cards in front of a records series because the disposition guide card also serves as a locator.) These cards will remain with cutoff files as long as they are retained in the current files area.

(1) *Replacement or Reuse of Cards.* Make new sets of cards as needed for cur-

rent accumulations of each records series. When noncurrent records are retired or destroyed, reuse the disposition guide cards for current accumulations.

(2) *Exceptions.*

(a) When it is not feasible to affix AF Form 82 to a guide card for placing in front of a records series, affix the label to the container housing the records. When the records series is housed in more than one container, affix the label to the first container or to each container.

(b) Do not prepare AF Forms 82 for records maintained for a period of time but never placed in filing equipment (such as safe check and room security inspection records). Instead, enter the disposition instructions immediately below the description of the records on AF Form 80 (see paragraph 10a(2)).

boards, cards, table drawers, etc

will include the file symbol, subject title, and year; e.g., "MGT 1-3, Maintenance of Current Records, 1966." In other records series, the label will include the item number from the AF Form 80, the identifying name, number, and/or symbol of the file series, and the year or inclusive dates, as appropriate. Place folders behind related guides. (See paragraph 17 for instructions on subdividing folders.)

13. Preparing Documents for Filing.

a. Insure that documents have been authorized for filing by the word "File" and that the initials of the authorizing official have been written on them as illustrated in figure 4. (Certain documents upon which current action is obviously completed do not require file authority; examples are: Memo for Record, classified document receipts, large volumes of single-type documents such as requisitions and bills of lading. In addition, specific categories of records may be exempted from these requirements when justified and approved by the records management officer.)

b. Insure that the file is complete and that all attachments are retained or accounted for.

c. Insure that parts of another file are not accidentally attached.

d. Destroy identical duplicate copies of documents to be filed in the same records series except the "originals" and "coordination (file) copies" of correspondence. Remove all mail control forms and receipts, classified cover sheets, envelopes, and memo routing slips except those containing remarks of significant record value.

e. Assemble documents for filing in the same manner as the prescribing directive requires for their creation, dispatch, and use—with the latest action on top.

f. Remove rubber bands, paper clips, pins, and other temporary fasteners. Mend, or reinforce with transparent tape, all torn or frayed papers.

g. Staple related papers together in the upper left corner. When the material is too thick to use wire staples, use prong fasteners to fasten related file material together.

14. Classifying (Coding) Papers for Filing. After the papers have been prepared for filing, the next step is to code or classify them. Classification segregates the papers into logical categories for ease of filing and finding.

a. For other than subjectively arranged files, use the item number from the AF Form 80 together with the identifying name, number, and/or symbol. In most instances, this identification is already somewhere on the paper. If the number, name, or symbol is prominently displayed, there is no need to mark the file code on the paper; if they are not, underline or circle the identifying data or write the appropriate file code in the upper right-hand corner of the paper—see figure 4. To code a paper for filing in item 9 of figure 3, write the item number in the upper right-hand corner of the paper and underline or circle the name of the individual. Another example is a paper to be filed in a records series with two major divisions and several subdivisions, e.g., a file arranged by "CONUS" and "Overseas" and further arranged by name of the organization concerned. If the paper shows only the organizational name, write the item number from the AF Form 80, the location (CONUS or Overseas), and underline or circle the organizational name. For papers to be filed in the "Transitory" file, the item number from the AF Form 80 is adequate classification.

b. In subjectively arranged files, first determine the major subjective category that represents the subject matter and the specific subdivision if needed. For example, a paper concerning the file classification system of an organization would be coded "MGT 3-1" to describe the category "Administrative Management" and subdivision "Current Records Maintenance." See paragraph 9d for further explanation of file coding.

15. Cross-References:

a. *Use.* When a paper to be filed has more

DATE 1 July 1966

INDEX: File #6B

TO: AFDASB

FROM: AFXXX

SUMMARY: Appointment of Local Security Officer

FILED: ADM 3

INDEXER: abc

REMARKS:

DD FORM 1 MAR 50 334

CROSS-REFERENCE SHEET

Figure 5. Example of DD Form 334, Cross Reference Sheet.

than one subject, or other coding under which it should be filed, or when a document is brought forward to be consolidated with another file, use DD Form 334, "Cross Reference Sheet," (illustrated in figure 5) as a filing aid. *Exception:* If extra copies of the paper to be cross-referenced are available or if "fast" copies can be conveniently made, use them instead of the DD Form 334 (see subparagraph c below for preparation instructions).

b. Preparation of DD Form 334, Cross Reference Sheet.

(1) *Date.* Type the date of the document being cross-referenced—day, month, and year (e.g., "1 June 1966"). If no date is shown, insert "ND" and approximate date.

(2) *Index.* List all cross-references which are marked. If more than one reference is required, use additional DD Forms 334 as needed.

(3) *To.* Enter name of individual or organization to whom the document is addressed.

(4) *From.* Indicate document originator.

(5) *Summary.* Enter subject line of document being cross-referenced. If further identification is needed, include names, serial numbers, sums of money, or other supplementary information.

(6) *Filed.* Enter file designation of the document. For continuity cross-references, place the new date (under which the document will be filed) in parentheses after the file code, e.g., "MGT 1-1 (1 Jan 66)."

c. Using Copies for Cross-References. When extra copies are used for cross-references, mark them as illustrated in figure 4. Circle the file code to indicate where the extra copy is to be filed as a cross-reference. When "fast" copies are to be used, mark the record copy as illustrated in figure 4 before making the "fast" copies. Circle the cross-reference file designation on the copy to indicate where it will be filed as a cross-reference. For continuity cross-references, indi-

cate the date under which the document will be filed as prescribed in subparagraph b(6) above.

16. Sorting Records. Sorting is the procedure for arranging records in proper sequence to facilitate filing. It also provides ready reference to the records if they are needed before actual filing in the appropriate folders. The extent to which records need to be sorted depends upon the volume and filing arrangement. See paragraph 24g(3) for types of recommended sorting devices.

a. *Subjective Files* should be sorted and arranged first by major subjective category. Then, sort each major category into primary and secondary subdivisions as required.

b. *Alphabetical Files* may be sorted, if the volume is small, by arranging papers to the first letter of the surname only. For larger collections, it may be necessary to sort papers to the first several letters under which the papers are to be filed. When this is necessary, the alphabetical subdivisions contained in figure 2 can be used as a guide or basis for labeling the sorting equipment.

c. *Numerical Files* may be sorted, if the volume is small, by the basic numbers 0 through 9, e.g., in groups 1-999, 1000-1999, 2000-2999, etc. If the volume is large, sort each group into hundreds, then each hundred group into tens, etc. Numerical labels on sorting equipment from 0 through 9 can be used to represent tens, hundreds, thousands, etc. For example, 9 may also represent 90, 900, 9000, etc. Sort documents to be filed by terminal digit into groups from 00 to 99 to make 100 groups. If filing is to be by the primary group only, arrange the subsequent digits of the whole number in conventional numerical sequence within each primary group. However, if further sorting is required, sort each primary group by the first digit of the secondary group and each resulting group by the second digit of the secondary group. Subsequent digits are filed in conventional numerical order within each group.

17. Filing Procedures. Match the file codes of

the papers with the folder labels before placing papers in the folders. File the papers loosely in the proper folders with the latest date in front. Avoid fastening papers to folders with prong fasteners unless the folders are frequently used away from the files area. When filing papers in folders with prong fasteners, do not punch and fasten the papers until the folders are charged out. Keep folder labels visible by neatly arranging papers in the folders. When the contents of the folders increase to the point that papers begin to obscure folder labels, crease the bottom of the front folder leaves at the scored expansion lines to increase the capacity of the folder. When folder content reaches $\frac{3}{4}$ inches, either (1) add a new folder bearing the same file designation in front of the full folder and show inclusive dates on the folders or (2) subdivide the contents of the folder, if practical, by adding new file designations. Prevent "overcrowding" the files by allowing at least four inches of space in each active file drawer to permit sufficient working space. Avoid cluttering the files by filing bulky material in equipment suitable to its size and filing cross-references with the related file papers. Mark the bulky material to indicate location, file code, and any additional information which will readily identify it with the related papers in the regular files.

18. Labeling File Drawers. Identify the contents of each file drawer on the file drawer label. Normally, each drawer label will include titles of the records series or segment(s) of a records series and the years covered, e.g., "Special Orders (Series G), 1966." See *AFR 205-1* and *local implementing security directives before labeling cabinets containing security classified material.*

19. Using Charge-Out Records (AF Forms 614 and 614a). Prepare AF Forms 614 or 614a to place in the files as a substitute for papers, folders, or 5" x 8" cards borrowed or permanently withdrawn from the files. Office identification (symbol, abbreviation, etc.) and telephone number of the individual

charging out the records may be included on the form if needed. File AF Forms 614 and 614a so that the "OUT" portion is visible. This facilitates identification of charged out files and expedites refiling them. For permanently withdrawn files, the identifying data may be rubber-stamped if the volume of withdrawals warrants. Consistent use of these forms eliminates much wasted effort in searching for documents while they are out of the files.

20. Filing Classified Records. Safeguard classified files according to *AFR 205-1*. File classified records separately, except when it is necessary to maintain the continuity of a particular transaction or event, or the volume of unclassified material is too small to justify establishing separate files. Indicate on the folder the highest classification of the records filed therein (see chapter 3, *AFR 205-1*). Otherwise, label and file designations should be the same in all other respects as the folders containing unclassified material. Folders containing classified material must be filed in equipment authorized for each classification (see chapter 5, *AFR 205-1*). If folders containing classified material are to be filed with folders containing unclassified material, place each classified folder directly behind the folder containing unclassified material of the same type. When classified and unclassified material are filed in the same filing cabinets and additional filing space is needed, segregate the classified and unclassified material and file in separate cabinets to avoid procuring additional approved security containers. When there are both classified and unclassified folders on the same subject maintained separately, place a cross-reference in both folders. When a classified document is to be added to a voluminous unclassified file, substitute a cross-reference sheet for the classified document and file the classified document separately in available approved security containers. *Do not include any classified information on the cross-reference sheets that are to be filed in an unclassified file.*

21. Files Cutoff Procedures. Files "cut off" is the segregation of active and inactive files. Established periodic cutoff of files is essential to effectively control records accumulations and their growth and to facilitate economical disposition in convenient blocks. At least annually, records clerks will cut off files and segregate inactive files from active files; dispose of files eligible for retirement, transfer, or destruction (see AF Forms 82); and destroy all noncurrent technical reference materials (see subparagraph f below).

a. For files maintained on a calendar year basis, cut off on 31 December of each year and establish new files the next day.

b. For files maintained on a fiscal year basis, cut off the files at the end of the applicable fiscal year and establish new files the following day (or on the first day of the new fiscal cycle). For example, when fiscal year 1966 is established to include 1 July 1965 to 30 June 1966, cutoff would be on 30 June 1966 and fiscal year 1967 files established the next day—1 July 1966, etc.

c. For files with a retention period of less than one year (or when the volume and reference value require that only a portion of the file be kept active) maintain them on a daily, weekly, or monthly basis, cut them off on that basis, and dispose of after their authorized retention period. For example, large accumulations of records which are disposable after six months, could be cut off at the end of each month, a new file started the

next day, and the cutoff files disposed of after six months.

d. Records subject to audit or inspection may be:

(1) Cut off as of the closing date of the period covered by the audit or inspection, *or*

(2) Maintained on a calendar or fiscal year basis and either:

(a) Flagged by using a file guide to facilitate disposition of that portion of the file which has been audited or inspected, *or*

(b) Retained for a sufficient period of time to insure that all audit and inspection requirements have been met before the records are disposed of.

e. Files maintained as "case" or "project" files are cut off upon the occurrence of a certain event, such as separation of personnel, final contract payment, or project completion. Upon cut off, place all completed or closed case files in an inactive file. (Unless otherwise specified in AFM 181-5, maintain inactive files on an annual basis.) Then, remove and dispose of the oldest inactive file and case working papers as authorized in AFM 181-5.

f. Since there is no established cut off for most technical reference materials, dispose of them in accordance with AFM 181-5 when they are superseded, obsolete, or no longer needed. At least annually, review these materials to determine that they are current, thus insuring their usefulness. (See AFR 5-31 for guidance on maintaining publications.)

*Legal size folders
can legal size material*

Chapter 4

FILING SUPPLIES AND EQUIPMENT

22. Objectives. A continuing objective is to provide for the proper, complete, and economical use of filing supplies and equipment. Filing supplies and equipment used by Air Force activities will be the most economical possible to meet filing requirements. Do not request filing equipment solely to improve appearance, office decor, status elevation, or because of the desire for the latest design or more expensive types. Maintain only the material needed to conduct current business in filing supplies and equipment in office space. (See TA 006 for additional standard allowances and use criteria. See paragraph 26 before requesting the equipment described in paragraphs 24 and 25 below.)

23. Standard Filing Supplies. The following items are to be used by all Air Force activities as required. (See paragraph 25 for guidance when these supplies will not meet filing requirements.)

a. *Folders.* Exceptions to the use of the following standard folders may occur when supply activities furnish the user with non-standard items such as manila folders of comparable size and comparable or lighter weight.

(1) *Kraft* folders will meet the majority of filing requirements since most records are current for a relatively short time before they are retired or destroyed. The standard kraft folder will be 147-pound, 11 point, natural color, vertical, flat type, blank, bottom scored for $\frac{3}{4}$ " expansion, reinforced top, and square cut:

(a) *Letter Size:* FSN 7530-663-0031, $9\frac{1}{2}$ " x $11\frac{3}{4}$ " \$1.35 per 100 (Manila 5/18)

(b) *Legal Size:* FSN 7530-200-4308, $9\frac{1}{2}$ " x $14\frac{3}{4}$ " \$1.50 per 100

(2) *Pressboard* folders are authorized only for case and project files and then *only* when the kraft folder will not withstand the added volume and/or use. The standard pressboard folders are flat-type, gray, blank, vertical, one-inch expansion, with self tabs, and square cut:

(a) *Letter Size:* FSN 7530-~~286-1720~~⁹²⁶⁻⁸⁹⁸¹, $9\frac{1}{2}$ " x $11\frac{3}{4}$ " \$10.50 per 100

(b) *Legal Size:* FSN 7530-~~264-8646~~⁹²⁶⁻⁸⁹⁸², $9\frac{1}{2}$ " x $14\frac{3}{4}$ " \$11.50 per 100

b. *Guide Cards.* (See paragraph 24e for shelf-filing guide cards.) The standard guide cards are gray pressboard, one-third cut, self tab, without lower projections, all positions:

(1) *Letter Size:* FSN 7530-989-0683. \$2.35

(2) *Legal Size:* FSN 7530-082-2635. \$3.00

c. *Labels:*

(1) Gummed folder labels, blank, $3\frac{3}{4}$ " x $1\frac{1}{8}$ " in perforated fanfold strips, 500 to a box, available in several colors. FSN 7530-223-6606, -6607, -6609, -6611, and 7530-550-5926, depending on color. 15¢ per 100

(2) Pressure-sensitive (self adhering) labels, in sheets of 8 labels (248 labels to a box), $3\frac{1}{2}$ " x $\frac{1}{2}$ ", available in plain white or white with $\frac{3}{32}$ " wide identification strip in various colors. FSN 7530-577-4368 through 7530-577-4376, depending on color. 25¢ per 248 labels

24. Standard Filing Equipment. The following items are to be used by all Air Force activities as required. (See paragraph 25 for guidance when standard equipment will not meet filing requirements.)

a. *Vertical Filing Cabinets.* Maintain only

Graded 3/4" x 2 1/2" 10 MAY 67

material needed to conduct current business in these cabinets in office space. Filing cabinets are gray-finish steel, upright, 5-drawer, 1 drawer wide, 57 $\frac{1}{2}$ " high, and 28" deep.

(1) *Letter Size (15" Wide)*: FSN 7110-286-3799. \$57.00 (-3796 w/locks \$59.00)

(2) *Legal Size (18" Wide)*: FSN 7110-286-3797. Use only when at least one-fourth of the documents are legal size. Smaller quantities of legal size documents will be folded to fit letter size cabinets. \$60.00 (-3796 w/locks) \$62.00

b. Card Filing Equipment:

(1) *For 3" x 5" and 5" x 8" Cards.*

(a) Gray enameled steel cabinets with 16" deep drawers with compressor, label holder, and pull; four removable feet; stacking slots and interlocking lugs. One-drawer units: FSN 7110-273-8770 (3" x 5") and FSN 7110-273-8772 (5" x 8"). Two-drawer units: FSN 7110-273-8774 (3" x 5") and FSN 7110-273-8776 (5" x 8"). \$3.00 and 4.15 5.20 7.40

(b) Gray steel upright cabinets:

1. For 3" x 5" cards, 10 double drawers, FSN 7110-269-8451. —\$108.25
2. For 5" x 8" cards, seven double drawers, FSN 7110-273-9512. \$95.00

(2) *For 3 $\frac{1}{4}$ " x 7 $\frac{3}{8}$ " EAM Cards.*

(a) Ten double drawers, holds 66,000 cards, FSN 7110-273-9459. —163.00

(b) Eleven two-compartment drawers, holds 82,000 cards, FSN 7110-132-6496. \$194.00

(c) Two-drawer unit with compressors and stacking slots, 16" deep.

c. Cabinets for Maps, Plans, and Drawings.

Five-drawer cabinets, 15 $\frac{3}{8}$ " x 41 $\frac{1}{16}$ " x 53 $\frac{3}{4}$ " with waterproof fabric drawer covers. FSN 7110-205-0821. Separate base (FSN 7110-205-0822) and top (FSN 7110-205-0823) units are available. \$89.00 \$17.80 \$14.00

d. Cabinets for Machine Listings. These cabinets are "jumbo" file cabinets (18 $\frac{1}{4}$ " wide, 14 $\frac{5}{16}$ " high, and 25 $\frac{1}{32}$ " deep), three-drawers with "follow blocks" which hold listings in an orderly vertical position when filed in appropriate binders or separated by pressboard guide cards. This item

has not been included in the GSA Stores Stock Catalog; therefore, Air Force activities maintaining machine lists may locally procure these cabinets and guide cards. Among manufacturers of the "jumbo" file cabinets are All Steel Equipment Company, Art Metal Company, Art Steel Company, Atlas Stencil Files Corporation, Cole, General Fire-proofing, Shaw-Walker, etc. The following pressboard binders (with punched cloth hinges) listed in the GSA Stores Stock Catalog are most satisfactory for maintaining machine listings:

(1) 11" x 17," FSN 7510-281-4310 (3" capacity, with fasteners). \$5.50

(2) 11" x 14 $\frac{7}{8}$," FSN 7510-582-5488 (without fasteners). \$4.45

e. Shelf Filing. The standard shelf filing cabinet units described in (3) below may be more appropriate than filing cabinets for filing certain material.

(1) *Use.* Shelf filing is most adaptable to records that are alphabetically or numerically arranged such as case or project files. Consider shelf filing when these records total, or are expected to total, 200 linear feet or more, and when:

(a) The filing station is in a relatively permanent location.

(b) The purchase of new filing equipment is contemplated.

(c) Additional space for filing operations is required and only a limited amount of space is available.

(d) The area is relatively free from excessive dust and is not subject to infestation by rodents and vermin. When these conditions prevail, consider standard filing cabinets.

(2) *Factors to Consider.* Under the above conditions, shelf filing equipment costs less than standard filing cabinets, requires less office space, and permits ease of filing operations. Below are specific factors to consider when planning for shelf-filing:

(a) *Records*—must be easily maintained and referenced in shelf filing equipment.

ROYAL Metal Co.
Jan-31st 67
(USA) FSC GP 71-
li 710
3 October 1966
\$29.87

(b) *Cost.* Open shelf filing units cost considerably less per linear filing foot than standard filing cabinets. For example, a seven-shelf unit costs approximately half that of a standard five-drawer filing cabinet. (Closed shelf filing is not recommended because the cost is considerably more than standard filing cabinets.)

(c) *Space.* Shelf filing is used primarily when space is a problem since it provides better use of space than standard filing cabinets. For example, floor space for 80 linear feet of files requires 14.3 square feet of shelf units versus 23.3 square feet for drawer type units—39% more space for drawer units. A 7-shelf unit has 21% more linear feet filing capacity per square foot of space than a 5-drawer filing cabinet. Aisle space for operating shelf type units is a minimum of 30" versus a minimum of 36" for drawer type units. However, floor load should be carefully checked for adequacy and file units placed in a safe load carrying location.

(d) *Filing Operations.* In shelf filing equipment, removing and replacing folders and removing and inserting papers fastened to folders is 20% to 30% faster than in drawer type equipment. However, inserting and removing loosely filed papers is slower in shelf filing than drawer type units since the folder must be removed from the shelf—papers can be dropped into folders remaining in drawer type units. Compactness of shelf filing also results in less walking distance to files.

(e) *Appearance.* Untidy recordkeeping is easily seen in shelf units whereas untidiness in drawer units is hidden when drawers are closed.

(f) *Security.* Shelf filing units are not authorized for storage of classified material unless the units are located within a secure room or alarmed area (see AFR 205-1).

(3) *Shelf Filing Cabinet Units.* These units have knockout holes to permit fastening the units together side by side, back to back, or "stacking."

(a) Letter Size.

1. Three-shelf opening (36 $\frac{3}{4}$ " x 14" x 38"), FSN 7110-817-0646; with built-in base (36 $\frac{3}{4}$ " x 14" x 42"), FSN 7110-817-0657.

2. Seven-shelf opening, with built-in base (36 $\frac{3}{4}$ " x 14" x 84"), FSN 7110-817-0665; or with posting shelf, FSN 7110-817-0641. → 50.32

(b) Legal Size.

1. Three-shelf opening (36 $\frac{3}{4}$ " x 17" x 38"), FSN 7110-817-0671; with built-in base, (36 $\frac{3}{4}$ " x 17" x 42") FSN 7110-817-0662. → 34.10

2. Seven-shelf opening, with built-in base (36 $\frac{3}{4}$ " x 17" x 84"), FSN 7110-817-0669; or with posting shelf, FSN 7110-817-0667. → 61.15

(4) *Shelf Filing Accessories.* In addition to the items listed below, it may be necessary to obtain a step stool for access to upper shelves, depending on the height of the units.

(a) *Guide Cards.* Gray pressboard, calendered, Type III, $\frac{1}{8}$ " cut, self tab, all positions, with metal shelf hook: Letter size, FSN 7530-988-9787 (approximately \$5.75 per hundred); legal size, FSN 7530-988-9788 (approximately \$6.50 per hundred).

(b) *Folders.* Use the standard kraft folders prescribed in paragraph 23a(1) in shelf filing equipment. For better visibility, label the folders on the extreme right tab to provide left to right order.

(c) *Dividers.* Metal dividers are supplied with the equipment to support folders and guide cards. However, if additional dividers are necessary, use the following:

1. Letter size, FSN 7125-819-4245.
2. Legal size, FSN 7125-819-4246.

f. *Containers for Safeguarding Classified Material.* Maintain classified material in containers or areas prescribed in chapter 5, AFR 205-1.

g. *Equipment for Easier and Faster Filing.* Use of the following items, as required, can save time and facilitate filing.

- (1) *Filing Stools*—make filing in upper

and lower drawers easier: FSN 7110-634-9617 (14" high, with casters) and FSN 7110-634-9618 (26" high, without casters).

(2) *Filing Shelf*—holds papers for filing and attaches to file drawer handle, vinyl bumper protects drawer finish—FSN 7520-634-5922 (12 $\frac{3}{4}$ " x 11").

(3) *Sorting Devices*. When the volume of papers is small, desk trays, a table, or desk top can be used for sorting. However, a sorter is recommended for most small filing operations. It has a series of dividers, three to four inches wide, each hinged to a flat base. Tabs can be labeled and inserted as required. A 24-division sorter will generally meet the sorting requirements of a small office of record. Sorters with more divisions are available—some equipped with a sliding base mechanism. Other sorting equipment is available containing horizontal or vertical dividers. Also, rack sorters can be constructed to meet most sorting requirements.

25. Nonstandard Filing Equipment and Supplies.

As used in this manual, any filing equipment and supplies not listed in paragraphs 23 and 24 are "nonstandard." They will be procured only when the need for such equipment and supplies meets the criteria and requirements in paragraph 26 below.

26. Procedures for Requesting and Controlling Filing Equipment and Nonstandard Filing Supplies.

To insure adequate control and proper use of filing supplies and equipment, all Air Force activities will follow the procedures below. Commands may impose additional controls, as required, to meet these objectives.

a. *Records Custodians* will insure that the following actions are taken before requesting file equipment or nonstandard filing supplies.

(1) *General:*

(a) All records are identified on AF Forms 80 and 82 and are maintained according to this manual.

(b) All temporary records eligible for destruction have been destroyed.

(c) All noncurrent records not eligi-

ble for destruction have been retired to the records staging area or records center.

(d) Filing cabinets, including top and bottom drawers, are being fully used for material needed to conduct current business.

(e) All current records are maintained in the most economical equipment, such as shelf files.

(f) All security filing cabinets not being used for classified material have been exchanged for nonsecurity type filing cabinets.

(2) *Requests for Powered or Other Mechanized Filing Equipment:*

(a) *Factors*. Consider the following factors when planning the use of mechanized filing equipment:

1. The system for which the equipment is intended is well established and not likely to undergo changes which would eliminate the need for the equipment.

2. The site where the records are to be maintained is suitable. Because of the weight of the equipment, it may be necessary to reinforce floors or even preclude its use in some buildings. Also, insure that adequate electrical current is available to safely operate the equipment.

3. The proposed equipment will house a large concentration of records that need to be accessible to one individual at a time. If several persons need to reference the file at the same time, mechanized equipment is not practical and cannot be justified.

4. The filing station is in a relatively permanent filing location.

5. Since none of this equipment of this type is authorized to be used for storing security classified material, insure that adequate security precautions are taken—see AFR 205-1.

6. Adequate maintenance and repair facilities are available.

(b) *Justification*. If all of the above conditions are met, the equipment may be requested provided that the request includes specific evidence that the justification meets one or more of the following criteria and the total savings to be realized exceeds the differ-

ence between the cost of standard and mechanized filing equipment when prorated over a three-year period. (NOTE: Consult with various representatives (vendors) of commercial firms to obtain up-to-date information on the capabilities, limitations, and costs of the equipment that appears to be suitable for your requirements. Specific equipment, identified by manufacturer, make, model etc., may be requested but a commitment must not be made before approval by the records management officer.)

1. *Manpower Savings*—one or more positions (either existing or budgeted for) will be eliminated.

2. *Space Savings*—space saved through the use of the equipment will be used for other essential operating functions.

3. *Work Production*—any predicted increase in workload capability is based upon provable and current workload data.

(3) *Requests for Use of Patented Filing and Indexing Systems.* The use of filing and indexing systems which have been patented by the manufacturer or are protected by proprietary rights is prohibited before HQ USAF (AFDASB) approval. Requests for such systems should include a description of the system, name of manufacturer, and the records to be maintained thereby.

(4) *Requests for All Other Nonstandard Equipment and Supplies.* These requests will include specific evidence that standard equipment or supplies will not meet the needs of the requesting office in terms of reference or storage requirements, or will result in manpower savings or reductions in time and effort.

b. *Records Officers:*

(1) Review each request for all filing equipment and nonstandard filing supplies.

(2) Approve or disapprove each request based on a review of AF Form 80 and inspection of the records to insure compliance with paragraphs 24, 25, and 26a.

(3) Forward approved requests to the supply activity for necessary action—*except* those requests described in paragraphs a(2) and (3) above which he recommends for approval; forward such request, with appropriate comments, to the command records management officer.

(4) Periodically review the use of filing equipment to determine whether the equipment is being adequately used. If the equipment is not being properly used, recommend redistribution or return of the equipment.

c. *Records Management Officers:*

(1) Insure proper use and control of all command filing equipment and supplies.

(2) Review and approve or disapprove all request described in paragraph a(2) above proposed for use within their command.

(3) Submit these approved requests to the supply activity.

(4) Forward an information copy of each approved request for powered or mechanized filing equipment to HQ USAF (AFDASB).

(5) Forward all requests described in paragraph a(3) above which he recommends for approval, with appropriate comments, to HQ USAF (AFDASB) for final approval or disapproval.

BY ORDER OF THE SECRETARY OF THE AIR FORCE

OFFICIAL

J. P. McCONNELL
General, U.S. Air Force
Chief of Staff

R. J. PUGH
Colonel, USAF
Director of Administrative Services

Air Force Subjective Classification System Master Outline

Major Subjective Categories and Symbols

ADM OFFICE ADMINISTRATION
 CIV CIVILIAN PERSONNEL
 ADMINISTRATION
 COM COMMAND CONTROL AND
 COMMUNICATIONS
 ENV AEROSPACE ENVIRONMENT
 FIN FINANCIAL ADMINISTRATION
 INF INFORMATION ACTIVITIES
 INS INSTALLATIONS MANAGEMENT
 INT INTELLIGENCE
 INV INVESTIGATIONS, INSPECTIONS,
 AND SAFETY
 LEG LEGAL ADMINISTRATION
 MAP MAPPING AND CHARTING
 MED MEDICAL SERVICES
 MGT ADMINISTRATIVE MANAGEMENT
 MIL MILITARY PERSONNEL
 ADMINISTRATION
 MTN MATERIEL MAINTENANCE
 ENGINEERING
 OPS OPERATIONS
 PHO PHOTOGRAPHY
 POL POLICE OPERATIONS
 PRO PROCUREMENT
 PUB PUBLISHING AND PUBLICATIONS
 R&D RESEARCH AND DEVELOPMENT
 SEC SECURITY
 SUP SUPPLY AND SERVICES
 TNG TRAINING
 TRS TRANSPORTATION

ADM—OFFICE ADMINISTRATION
 Administration of Office Personnel
 Building Services
 Charity and Public Interest Campaigns
 Mail and Messenger Services (Local)
 Office Supplies and Equipment
 Security Procedures for Local Office

**CIV—CIVILIAN PERSONNEL
 ADMINISTRATION**

Accessions
 Career Development
 Compensation for Injury or Death
 Conduct
 Disciplinary Actions
 Gratuities and Favors
 Political Activity
 Death and Burial
 Detailing Employees
 Employee Relations
 Employee Groups

Equal Employment Opportunity
 Grievances
 Housing—Transportation—Food Services
 Insurance
 Government Life
 Hospitalization
 Recreation, Morale, Welfare
 Employment Records
 Official Personnel Folder
 Hours of Work
 Tours of Duty
 Leave
 Annual
 Sick
 Without Pay (LWOP)
 Pay Administration (Payroll Operations—
 see FIN)
 Employee Claims
 Indebtedness
 Overtime
 Pay Rate Determination
 Performance
 Awards—Commendations
 Incentive Programs (Suggestions)
 Ratings
 Appeals
 Standards
 Position Classification
 Position Series and Standards
 Surveys
 Promotion and Demotion
 Recruitment and Placement
 Applications
 Boards of Civil Examiners
 Overseas Employment
 Qualifications (Training, Experience, and
 Physical)
 Examinations (Mental and Physical)
 Selection
 Restoration after Military Service
 Separation
 Travel
 Passports—Visas
 Per Diem

**COM—COMMAND CONTROL AND
 COMMUNICATIONS**
 Command and Control
 Concept of Operations
 Definitions
 Doctrine, Plans, Policy, Objectives

Individual Systems—Programs
 C&C Support Systems
 Operational Combat C&C Systems
 Resources Management C&C Systems

Management
 Acquisition
 Operation
 R&D

System Processes—Functions
 Communications
 Control—Feedback
 Decision-Making
 Displays
 Information Collection
 Information Processing

Communications

Communications Center Operations
 Communications Accounts
 Message Transmission (Distribution
 and Control)
 Relay Centers

Communications Security
 Cryptosecurity Accounts
 Physical Security (Of Communications
 Facilities and Cryptomateriel) (Also
 see SEC)

TEMPEST Program
 Transmission Security

Communications Systems
 Airborne Communications
 Amateur Radio
 Fixed Ground Communications
 Ground Mobile Communications
 Military Affiliate Radio System
 (MARS)
 Tactical Communications

Frequency Management
 Compatibility Engineering
 Frequency Authorizations
 Frequency Engineering Above 30
 MCS
 Frequency Engineering Below 30
 MCS
 Records and Registration

Wire Facilities
 Commercial Facilities
 Control Stations
 Flight Checks
 Plant in Place Maintenance

ENV—AEROSPACE ENVIRONMENT

Geographical Requirements
 Techniques and Equipment

Space Environment
 Solar Observations
 Solar Forecasting
 Solar-Terrestrial Effects

Weather

Meteorological Analysis
 Climatology
 Forecasting
 Storm Tracking-Warning
 Meteorological Data Exchange
 Meteorological Observations

FIN—FINANCIAL ADMINISTRATION

Appropriation Accounting
 Advance Payments and Recoupments
 Allocation, Suballocation, and Allotment of
 Funds
 Administrative Control
 Advice of
 Records

Adjustments and Corrections
 Allocation, Suballocation Ledgers
 Allotment Ledgers
 Subsidiary Allotment Ledgers

Annual Budget Authorization

Claims

Collection
 Appropriation Receipts
 Appropriation Refunds
 Appropriation Reimbursements
 Deposit Fund Accounts
 General Fund Miscellaneous Receipts
 Records
 Control Ledgers
 Subsidiary Collection Ledgers
 Reporting Instructions and
 Requirements

Commitments

Disbursements, Expenditures

Inter-Intradepartmental Transactions

Obligations

Special Activities and Tenants

Auditing

Administration and Control
 Auditor's Records
 Internal Audits

Banking—Currency

Budgeting

Budget Program Management
 Annual Financial Plan
 Apportionments
 Appropriation Law
 Funds Administration
 Special
 Transfers

Budget Structure
 AF Budget Code (Fiscal Code)

- Estimates
 - Call for Estimates
 - Program Guides and Assumptions
 - Justification
 - Review
 - Special (Flash)
 - Supplemental
 - Federal Budget
 - Cost Accounting
 - Base Maintenance
 - Depot Maintenance
 - Field Maintenance
 - Motor Vehicles Maintenance
 - Expense Accounting
 - Accounting Procedures
 - Chart of Accounts
 - Contractual Services
 - Materiel
 - Medical Services
 - Personnel Services
 - Special Activities and Tenants
 - Travel and Transportation
 - Records
 - Expense Ledger—Accounts
 - Subsidiary Ledgers and Files
 - Reporting Instructions and Requirements
 - General Ledger Accounting
 - Accounting Procedures
 - Chart of Accounts
 - Special Activities and Tenants
 - Records
 - General Ledger Control Accounts
 - Subsidiary Ledgers and Files
 - Reporting Instructions and Requirements
 - International Accounting
 - Agreements, Bilateral
 - Canada
 - Korea
 - South Africa
 - United Kingdom
 - MAP (Grant Aid)
 - MAP (Military Assistance Sales)
 - NATO
 - Reporting Instructions and Requirements
 - SHAPE
 - Monetary Property Accounting
 - Equipment in Use
 - Financial Inventory Accounting
 - Medical Inventory Management System (MIMS)
 - Real Property
 - Nonappropriated Funds
 - Revenue Producing Activities and Funds
 - Book Department Funds
 - Exchange Service Funds
 - Motion Picture Service Funds
 - Post Restaurants Funds
 - Vocational Training Activities Funds
 - Sundry Association Activities and Funds
 - Central Mess Funds
 - Chaplains Funds
 - Installation and Organizational Religious Funds
 - Officers', Noncommissioned Officers', and Cadets' Open Messes
 - Welfare Activities and Funds
 - Base Trust Funds
 - Central Base Funds
 - Central Welfare Funds
 - Civilian Welfare Funds
 - Command Welfare Funds
 - Unit Funds
 - Payroll Operations (Civilian Pay) (Also see MIL)
 - Revolving and Working Capital Funds
 - Industrial Funds
 - Laundry and Dry Cleaning Services
 - Printing Services
 - Management Funds
 - Stock Funds
 - Air Force Academy Division
 - Aviation Fuels Division
 - Clothing Division
 - Monetary Allowance System
 - Commissary Division
 - Salvage and Surplus Materiel Accounting
 - Statement of Charges
 - Surety Bonds
 - Survey, Reports of
- INF—INFORMATION ACTIVITIES
- Information Activities
 - Community Relations
 - Civic Leader Liaison
 - Holiday and Special Event Observances
 - Off Base
 - On Base
 - Speakers Bureau
 - Internal Information
 - Air Force Radio and Television Service (AFRTS)
 - Base Newspaper
 - Bulletin Board Program
 - Commanders Call
 - Public Information
 - Media Inquiries
 - Media Visits
 - Releases
 - International Affairs
 - (Subdivisions as applicable to command and location, i.e., NATO, SEATO, MACV, NORAD, etc.)

Legislative Relations

Congressional Inquiries

(Subdivisions as applicable to command, i.e., legislative proposals, legislative programs, etc.)

INS—INSTALLATIONS MANAGEMENT

Facilities (Construction, Maintenance, and Operation)

Aerospace R&D Facilities (Excluding Buildings)
 Airfields, Pavements, Aprons, etc.
 Building Equipment
 Buildings and Structures (Subdivide by type as required)
 Custodial Services
 Fire Protection and Aircraft Crash Rescue Grounds
 Insects, Rodent, and Vermin Control
 Liquid Fuel Storage and Dispensing Systems
 Missile Launch and Launch Control Facilities
 Railroads
 Roads and Other Surfaced Areas (Excluding Airfields, Pavements, etc.)
 Training Aids
 Utilities
 Air Conditioning Systems
 Electric Plants and Systems
 Gas Plants and Systems
 Heating Plants and Systems
 Sewage Plants and Systems
 Water Plants and Systems

Family Housing

FHA Housing
 Title VIII Housing (Wherry Housing)

Planning Engineering

Construction Planning (Program and Projects)
 Design Criteria
 Master Planning (Programs)

Real Estate

Accounting and Inventory
 Acquisition
 Disposal
 Utilization

INT—INTELLIGENCE

Collection—Dissemination

Attaches, Defense
 Attaches, Air
 Briefing
 Captured Materiel
 Clandestine Source
 Documents
 Electronic Collection

Communications

Collection-Dissemination
 Interception

Electronics

Collection-Dissemination
 Interception
 Multi-Sensor

Foreign Nationals

Accreditation
 Tours
 Visits

Guidance Material

HUMINT

Biographical Data
 Debriefing
 Interrogation
 Resources

Intelligence Collection Plans

Intelligence Reports

Photo Intelligence

Reconnaissance

Requirements and Priorities

Estimates

Air Facilities

Airfield & Seaplane Stations of the World

Climatology

Communications

Terrain

Transportation

Air Order of Battle

Air Defenses

Civil Air

Strategic Establishments

Tactical Establishments

Area Studies

Geographical Regions

Battle Staff

Capabilities

Economic

Military

Political

Technical

Indications

Aerospace Threats

Briefings

Current Indications

Intentions

Economic

Military

Political

Technical

Watch Reports

Operational Plans

Intelligence Annexes

Scientific and Technical Intelligence

Aeromedical Intelligence

Aircraft & Aircraft Engines

Antiaircraft Artillery

Armament, Conventional

- Ballistic Missiles
 - ICBM
 - Rockets, Air to Air
 - Rockets, Ground to Air
- Electronics
 - ELINT
 - Radar
 - Radio
 - Sensors
 - SIGINT
- Reconnaissance
 - Unidentified Flying Objects
- Information Disclosure Policy
 - Delegated Disclosure Letters
 - Disclosures Made
 - Foreign
 - U. S. Requesters
 - Requests for Disclosure
 - Authority
- Intelligence Training
 - Evasion & Escape Briefings
- Target Intelligence (Analysis and Compilation)
 - Physical Vulnerability
 - Weapons Effects
 - Weapons Recommendations
 - Weapons Requirements
 - Target Analysis
 - Bombing Encyclopedia
 - Damage Predictions
 - Target Systems
- Target Intelligence Requirements and Priorities
- Target Materials
 - Air Objective Folder Program
 - Radar Target Intelligence
 - Target Dossiers (Tactical)

INV—INVESTIGATIONS, INSPECTIONS, AND SAFETY

- Investigations
 - Liaison
 - Technique
 - Types
 - Counterintelligence
 - Collections and Operations
 - Criminal
 - Personnel
 - Procurement
- Inspections and Staff Visits
 - Personal Conference Periods
 - Scheduling
 - Special Subjects for Inspection
 - Types
 - Compliance
 - Procedural
 - Special
 - Staff Visits

- Safety
 - Accident/Incident Reporting
 - Awards
 - Programs
 - Statistics
 - Studies, Surveys, and Visits

LEG—LEGAL ADMINISTRATION

- Administration of Military Justice
 - Appellate Review and Procedure
 - Clemency
 - Correctional Custody
 - General Courts-Martial
 - Nonjudicial Punishment
 - Special Courts-Martial
 - Summary Courts-Martial
- Alcoholic Beverage Control
- Claims
 - Claims Against the U. S.
 - Claims Data Management System
 - Claims in Favor of the U. S.
 - Copyright Infringement Claims
 - Invention Secrecy Claims
 - Patent Infringement Claims
 - UCMJ Article 139 Claims
- Copyrights
- Labor Relations
 - Air Force Employees
 - Contractor Employees
- Legal Assistance
 - Adoption
 - Civil Relief Act
 - Divorce—Separation
 - Leases
 - Marriage
 - Power of Attorney
 - Wills
- Legal Opinions and Interpretations
 - (Use the Index in the "Digest of Opinions—The Judge Advocates General of the Armed Forces" to subdivide subject files as required)
- Litigation
 - Litigation Against Air Force Personnel
 - Reports
 - Witnesses
- Public Utilities
 - Communications
 - Electricity
 - Gas
 - Sewage
 - Transportation
 - Water

Taxation

- Federal Excise
- Federal Income
- State Excise
- State Income
- State Sales and Use
- State Tax, Other

MAP—MAPPING AND CHARTING

Aeronautical Information Publications

- Aeronautical Overprints
- Foreign Clearance Guides
- Jet Flight Information Manuals
- Pilot's Handbooks
- Radio Facility Charts

Air Target Materials

- Geodetic Data Sheets
- Radar Return Codes
- Reliability Data Sheets
- Target Charts
- Target Mosaics

Chart Quantities and Stocks

Development

- Experimental Items
- Portrayal
- Test and Evaluation

Distribution

- Exchange Agreements
- Hydrographic Charts

Maps

Production

Requirements

Source Materials

- Evaluation of
- Dissemination
- Procurement
- Utilization

Special Charting Items

- Aeronautical Video Plate
- Special Charts
- Special Mosaics
- Terrain Models

Standard Series Aeronautical Charts

- Aeronautical Approach Charts
- Aeronautical Planning Charts
- Cloth Charts
- Crash Grid Charts
- Equidistant Charts
- Evasion Charts
- Navigation Charts
- Radar Tracking Charts
- Strategic Charts
- Weather Charts
- World Aeronautical Charts

MED—MEDICAL SERVICES

Aeromedical Evacuation

- Inter-Theater Evacuation
- Intra-Theater Evacuation

Aerospace Medicine

- Aerospace Crew Effectiveness
- Bioenvironmental Engineering
- Epidemiology
- Military Public Health
- Occupational Medicine

Dentistry

- Accreditation
- Authorized Dental Treatment Rooms
- Facilities and Construction—Dental
- Criteria
- Consultants
- Dental Clinic Administration
- Career Guidance
- Dental Operating Instructions
- Physical Standards
- Dental Health Records
- Dental Reports
- Laboratory Services
- Area Support
- Satellite Bases
- Professional Services
- Examination and Treatment Planning
- Policies
- Preventive Dentistry
- Clinical Phase
- Community Health
- Special Dental Materials
- Accountability
- Artificial Teeth
- Chrome Alloy
- Specialty Sections
- X-Ray Dental
- Film Control
- Radiation Monitoring

General Medical and Health Status

- Aerospace Crew Effectiveness
- Battle Casualties
- Diseases
- Eye and Adexa and Ear, Eye, Nose,
- and Throat
- Circulatory System
- Digestive System and Hernia
- Digestive Tract, Infection Arising in
- Gynecology and Obstetrics
- Infective and Parasitic, Other
- Mental Psychoneurotic and Personality
- Disorders
- Neoplasma
- Nervous System
- Respiratory System
- Acute Infection in
- Other Diseases of

- Skin and Cellular Tissue
- Tuberculosis
- Venerial
- Urinary and Male Genital System
- Injuries
- Hospital and Dispensary Administration
 - Capacity and Status
 - Clinical Records
 - Patient Management
 - Admissions
 - Bed Occupancy, Patient Days & Length of Stay
 - Deliveries
 - Dispositions
 - Outpatients
- Medical Intelligence
- Medical Nomenclature and Classification
- Physical Examinations
- Professional Services and Clinics
 - Flight Medicine
 - Laboratory
 - Medical
 - Cardiovascular
 - Dermatology
 - Gastroenterology
 - Internal Medicine
 - Pediatrics
 - Physical Medicine
 - Psychiatry and Neurology
- Nursing
- Pharmacy
- Roentgenology
- Surgical
 - General Surgery
 - Obstetrics and Gynecology
 - Orthopedic Surgery
 - Urology
- Strength Statistics
- Veterinary Services
 - Animal Service
 - Base Veterinary Service
 - Food Inspection
 - Food Source Establishment Inspections
 - Government Verification of Contractor Inspection
 - Quality Audit
 - Veterinary Public Health
 - Environmental Sanitation
 - Epidemiological Investigations of Food-borne Diseases
 - Food Service Sanitation
 - Zoonosis Control
 - Veterinary Research
 - Basic Research
 - Research Support

MGT—ADMINISTRATIVE MANAGEMENT

- Communications (Written)
 - Accountability
 - Format
 - Processing
 - Stationery Specifications
- Data Automation and Reports Management
 - Advanced Technology
 - Data Management
 - Reports
 - Elements and Codes Standardization
 - Requirements Control
 - Data Systems
 - Approval
 - Compatibility
 - Development
 - Projects
 - Equipment Review
 - Program Management
 - ADPE Evaluation
 - Contract Negotiation
 - Control
 - Data Systems Evaluation
 - Indoctrination and Education
 - PCAM Approval
- Forms Management
- Historical Documentation and Properties
 - Historical Properties
 - Monographs
 - Unit Histories
- Interservice Relations (Joint Activities)
- Management Planning and Improvement (Surveys and Studies)
 - Office Methods and Procedures
 - Organizational Analysis
 - Program Planning and Analysis
 - Work Measurement—Production
 - Layout and Materiel Flow
 - Production Control and Scheduling
 - Survey and Audit
 - Work Measurement
 - Work Simplification
- Manpower
 - Deferred Manpower Requirements
 - Manpower Authorization Document (MAD)
 - Manpower and Authorization Files (MAF)
 - Unit Manning Document (UMD)
- Organization and Functions (Including, generally, the organization of boards and committees. Classify documents pertaining to the organization and work of specific boards and committees by subject, using the name of the board or committee as the subdivision of subject, as required)
 - Activation

- Assignment of Organizational Units
 - Unit Movements
- Constitution
- Designation
 - Insignia—Flags
 - Nomenclature
- Disbandment
- Discontinuance
- Inactivation
- Reorganization
- Postal and Courier Service
 - Courier System
 - Courier Transfer Stations (CTS)
 - Distribution
 - Money Orders
 - Penalty Matters
 - Post Offices (APOs)
 - Postage
 - Postal and Courier Equipment
- Records Management
 - Current Records Maintenance
 - Documentation Storage and Retrieval Systems
 - Records Disposition

MIL—MILITARY PERSONNEL

ADMINISTRATION

- Absence
 - AWOL
 - Desertion
 - Leave
 - Emergency
- Assignment and Reassignment
 - Air Force with the Armed Services of U. S. and Other Countries
 - Armed Forces of the United States with the Air Force
 - Armed Forces of Other Countries Serving with the Air Force
 - Attached
 - Flying Status
 - Permanent Change of Assignment and/or Stations (PCS and/or PCA)
 - Base of Preference/Base of Terminal Service Assignments
 - Consecutive Tours
 - Deferments and Humanitarian Assignments
 - Overseas Assignments
 - Permissive and Project CHAP Reassignments
 - Secretarial Determination on Second PCS in Fiscal Year (DLA)
 - Special Duty Assignments
 - Release
 - Temporary Duty

- Career Development
 - Classification
 - Qualification Records (Such as AF Form 11, etc.)
- Chaplaincy
 - Cultural Activities
 - Ecclesiastical Indorsing Agencies
 - Humanitarian Services
 - Personal Counseling
 - Preaching Missions
 - Jewish
 - Protestant
 - Roman Catholic
 - Religion
 - Jewish
 - Protestant
 - Roman Catholic
 - Religious Education
 - Retreats
 - Jewish
 - Protestant
 - Roman Catholic
 - Worship
- Discipline and Conduct
 - Misconduct
 - Administrative Reprimand
- Military Personnel Data and Records
 - Personnel Data Systems
 - Airmen
 - Officers
 - Records
 - Command Personnel Records Group
 - Field Record Group
 - Master Personnel Records Group
- Pay and Allowances
 - Allotments
 - Dependents
 - Income Tax
 - Pension
 - Savings
 - Benefits—Gratuities—Compensation
 - Clothing Allowances
 - Enlistment Bonus
 - Flying Pay
 - Inactive Duty Training Pay
 - Pay Withheld or Delayed
 - Quarters
 - Student Officers
 - Subsistence
 - Travel
- Performance
 - Commendations
 - Decorations and Awards
 - Effectiveness Evaluation
- Personal Affairs
 - Air Force Aid Society
 - Casualty Assistance

Casualty Reporting and Notification
 Children Have a Potential (CHAP)
 Counseling
 Credit Unions
 Family Services
 Insurance
 Leave
 Marriage
 Retired Servicemen's Family Protection
 Plan (RSFPP)

Personnel Services

Nonappropriated Fund Management

Book Department
 Personnel Services Supply
 Theater

Open Messes

Airmen
 NCO
 Officer

Recreation Services Management

Aero Clubs
 Bowling
 Crafts and Hobbies
 Golf
 Libraries
 Marinas
 Miscellaneous Activities
 Recreation Areas
 Riding Stables
 Rod and Gun Clubs
 Service Clubs
 Sports
 Swimming
 Youth Activities

Personnel Statistics

Average Strength Report
 Military Strength Balance Report
 Rosters
 Strength

Political Activities

Voting

Prisoners of War

Allied
 American
 Enemy

Procurement

Appointment and Enlistment

Examinations (Mental and Physical)
 Qualifications (Education and
 Physical)
 Waivers

Induction and Recall

Draft Deferment

Recruiting

Promotion and Demotion

Rank and Precedence

Retirement

Separation

Death
 Discharge
 Inactive Duty

Uniforms (Regulations of Apparel)

MTN—MATERIEL MAINTENANCE ENGINEERING

Conservation Practices
 Contractor Technical Assistance
 Equipment Histories
 Materiel Items (Subdivide as required in accordance with standard classes of supply (AFM 67-1) using class numbers in parentheses as secondary subject designations, viz: MTN 4 (01).)

Modification

Performance Data
 Preventive Maintenance
 Repairs
 Technical Order, Compliance
 Unsatisfactory Reports

OPS—OPERATIONS

Air Bases, Use of

Domestic
 Foreign
 Site Surveys

Air Traffic Control

Aircraft Dispatch and Clearance
 Identification
 Air Routes
 Control Tower
 Flight Rules and Regulations

Atomic Warfare

Liaison (Atomic Energy Commission, Military Liaison Committee, Armed Forces Special Weapons Project) (Also see INF)

Maneuvers
 Tests

Clandestine Operations

Electronics Systems

Airborne Radar
 Aircraft Control and Warning
 Radar Calibration
 Combat Electronics

Flight Operations

Airlifts
 Air Ground Rescue
 Air Sea Rescue
 Bombardment

Evacuation

Disaster
 Wounded (See Aeromedical Evacuation—MED)

Fighter

- Ground Support
- Reconnaissance
- Special Missions
- Transport
 - Inflight Refueling
- Troop Carrier
- Joint Operations
- Navigation
 - Navigations Aids
- Operations Analysis
- Studies
 - Airlift
 - General Purpose
 - Strategic
 - Tactical
- War Plans
 - Combined War Plans
 - Foreign Military Assistance
 - Defense
 - Civil Defense
 - Mobilization
 - Civil Aviation
 - Joint War Plans
 - Logistics
 - Offense
 - Biological and Chemical
 - Psychological
 - Strategic
 - Tactical
 - Ground Support

PHO—PHOTOGRAPHY

- Aerial Mapping and Charting
 - Cross Servicing Agreements (Interagency)
 - Identifications and Titling
 - Mapping and Charting Projects
 - Print Libraries
- Armament Recording Photography
 - Gun Cameras
 - Other
 - Scope Cameras
 - Strike Cameras
- Base Photograph Laboratories
 - Camera Operation
 - Distribution
 - Film Control
 - Finishing
 - Processing
- Documentation
 - Motion Picture
 - Processing and Printing
 - Still
- Instrumentation
 - Distribution
 - Motion Picture
 - Printing
 - Processing
 - Still Picture

- Motion Picture Photography
 - Animation
 - Archival
 - Exhibition Clearance and Classification
 - Processing
 - Production
 - Projection Prints
 - Public Sale and Release
 - Sound Recording
 - Stockfootage

Programming

- Annual Budget
- Annual Production Requirements
- Current File Production Status
- Policy Directives
- Rate of Production Status
- Standing Operating Procedures
- Technical Bulletins
- Utilization and Control

Television

- ACERPS by Command and Base
- Boards and Committees
- CEIPS by Command and Base
- Financial Administration
 - Budget
 - Contractual Services
 - Procurement
 - Project "Savings"
- Inquiries
 - Congressional
 - General Officers
- Manpower and Organization
- Policy
- Programming
 - Five Year CCTV Management Program
- Special Projects
 - Intrusion Resistant Cable
 - Secure TV (KG-24) TV Vans
- Studies

POL—POLICE OPERATIONS

- Police Administration
 - Authority and Jurisdiction
 - Civil Police Liaison
 - Complaints
 - Individual Case Files
 - Disposition of Offender Reports
 - Gate Guarding
 - Offenses or Incidents (Including Arrests and Routine Investigations of Delinquency and Complaints)
 - Patrolling
 - Permits (Hunting, Fishing, Firearms, etc.)
 - Property

- Records of Events (Desk Journal)
- Relief Schedules
- Security and Law Enforcement Activities
 - Reports
- State of Discipline
- Traffic Control
- Vehicle Registration

Corrections

- Casual Prisoners
- Confinement Administration
- Confinement Operations
- Prison Administration
- Prisoners Complaints
- Prisoners Individual Records
- Restoration and Clemency
- Retraining of Prisoners

PRO—PROCUREMENT

Contract Administration

- Contractor's Records
- Cost Reimbursement (Approval of Cost)
- Price Redetermination
- Subcontracting
- Tax Exemption

Contract Financing

- Advance Payment
- Guaranteed Loans
- Partial Payments

Contract Placement

- Bonds
- Coordinated Procurement
- Execution (Awards)
 - Approval
 - Distribution
 - Numbering
- Formal Advertising
- Interdepartmental Procurement
 - Federal Supply Service
- Negotiation
 - Findings and Determinations
- Sources
 - Bidders List
 - Small Business
- Specifications

Contractual Instruments

- Changes
- Types
 - Cost-Plus-Fixed-Fee
 - Fixed Price
 - Time and Materials

Foreign Procurement

Government Property

- Bailment
- Government-Furnished Aeronautical
 - Equipment
- Industrial Property Control

Industrial Resources

Facilities

- Industrial Equipment
- Modernization/Replacement
- Plant Expansion
- Special Tooling

Labor and Technicians

Materials

- Controlled Materials
- Customs Entry
- Priorities

Mobilization

- Production Planning

Initiation of Purchase and Procurement

Authority

- Assignment of Procurement Responsibility
- Delegation of Authority
- Procurement Directives
- Purchase Requests

Labor Relations

- Inquiries
- Labor Disputes
- Labor Laws

Procurement and Contract Management

- Reports
- Surveys

Production

- Delivery Schedules
- Engineering Changes
- Expediting

Programming

- Requirements Computation

Quality Control

- Inspection and Acceptance

Readjustment

- Claims
- Property Disposal
- Settlement
- Termination
 - Convenience
 - Default

Reliability

- Management Procedures
- Operational Reliability
- Specifications

Standardization

Domestic

- Aircraft, Rocket, & Missile Designation
- Documentation
- Engineering
- Qualified Products List
- Supply

International

Air Standardization Coordinating
Committee (ASCC)
CENTO
NATO
SEATO

Value Engineering

Change Proposals
Manning
Training

Zero Defects

Awards to Industry
Crossfeed Items
Publicity/Promotions

PUB—PUBLISHING AND PUBLICATIONS

Orders

Aeronautical
Court-Martial
Flight
Movement
Reserve
Special

Publishing Management

Budget and Fiscal
Printing, Binding, and Reproduction
Binding
Contract Printing
Departmental Printing
Duplicating
Field Printing

Publications

Distribution and Requirements
Format and Editorial Policy
Procurement

R&D—RESEARCH AND DEVELOPMENT

Aircraft

(Subdivide as required: amphibian; bomber; cargo and transport; convertiplane; fighter; glider; liaison; lighter-than-air; parasite; reconnaissance; rotary wing; and trainer).

Aerodynamics (Exclusive of propellers and rotors)

Airfoils
Boundary Layer Control
Design Criteria
External and Internal Flow
Fluid Mechanics
Turbulence
Wind Tunnel Studies

Alighting Gear

Antiskid Devices
Brakes, Tires, Wheels
Cross-wind Landing Devices
Floats, Skis
Steering

Components

Fuel Cells
Fuselages
Tail Assemblies
Wings

Design

Escape and Recovery
Load, Weight and Balance
Parameters
Passive Defense
Performance
Pressurization
Structural Testing

Electrical Accessories

Actuators
Auxiliary Power Plants and Generators
Circuit Breakers
Convertors, Regulators
Motors

Flight Instruments

Accelerometers
Airspeed
Altitude
Free Air Temperature
Pitch and Yaw

Flight Operation Techniques and Equipment

All Weather Operation
Cruise Control
Floating Wings
Range
Towing
Unconventional Landing and Takeoff

Maintenance and Test

Engine Test Cells, Stands
Repair Equipment

Mechanical Accessories

Aerial Delivery Equipment
Actuators
Aerial Dispensers
Cooling and Air Conditioning
Deicing and Anti-icing Devices
Fire Prevention Equipment
Heating Equipment
Hydraulics
Inflight Cargo Handling Equipment
Oxygen Equipment
Pneumatic

Propellers and Rotors

Aerodynamics of
Components
Control
Drive Mechanism

Servicing and Handling

Fueling and Fuel Storage
Gas Generators and Gas Servicing
Heating and Air Conditioning
Launchers and Arresters
Lubrication Equipment
Mobile Compressed Air Supply

- Stability and Control
 - Control Mechanisms
 - Control Surfaces
 - Criteria
 - Dynamic Load
 - Flutter, Vibration
- Armament
 - Aircraft Armor (Plates, Bullet Proof Glass, etc)
 - Ammunition and Guns (Exclusive of Fire Control System)
 - Accessory Equipment
 - Destructive Effects
 - Drives
 - Feed and Storage (Aboard Aircraft)
 - Mounts
 - Analysis and Evaluation
 - Ballistics
 - Computation
 - Control Theory
 - Dynamics of Systems
 - Performance Evaluation
 - Systems Synthesis
 - Bombs (Exclusive of Special Weapons) (Subdivide, as required, by type)
 - Bomb Accessories
 - Computers
 - Bombing
 - Ground Defense
 - Demolitions
 - Application
 - Techniques
 - Fire Control Systems
 - (Position reference — radar; optics; gyros; computers; servo-transmitters; all equipment applicable to an integrated fire control system)
 - Fuses
 - Mines and Torpedoes
 - Munitions Handling Equipment
 - Rockets and Launchers
 - Accessory Equipment
 - Destructive Effects
 - Feed and Storage (Aboard Aircraft)
 - Launching Equipment
 - Release Equipment
 - Rockets
 - Sights
 - Bombsights
 - Gunsights
 - Warheads
- Bioastronautics
- Chemistry
 - Analytical Physical
 - Inorganic, Organic
- Communication
 - Acoustics
 - Airborne Systems
 - Ground Systems
 - Linguistics
 - Receivers, Recordings
 - Telemetry
 - Theory of Information and Communication
 - Transmitters
- Electronics
 - Combat Electronic Application (Electronic Countermeasures)
 - Screening
 - Signal Search and Analysis
 - Simulation
 - Components, Techniques and Tests
 - Amplification
 - Antennas and Antenna Shelters
 - Meters, Generators
 - Modulation
 - Moving Target Identification
 - Signal Analysis
 - Electromagnetics
 - Analysis
 - Wave Propagation
 - Electronic and Electrical Parts (Subdivide as required)
- Engines
 - (Subdivide as required: gas turbines, turbo jets and turboprops; nuclear; ramjet; rocket)
 - Accessories
 - Instruments
- Equipment
 - Aerospace Ground Equipment (AGE)
 - Air Base Equipment
 - Auxiliary Power
 - Camouflage
 - Construction and Maintenance Equipment
 - Fire, Crash and Salvage Equipment
 - Lighting and Marking
 - Materials Handling
 - Personnel Carriers
 - Structures
 - Clothing and Protective Equipment
 - Machine Elements and Hardware
 - Medical and Dental Equipment
 - Rescue and Survival Equipment
 - Aerial Pickup and Tow
 - Airborne Sea Rescue Equipment
 - Detection Devices
 - Droppable Survival Gear
 - Flotation Gear
 - Personal Survival Clothing
 - Rescue Boats and Equipment

- Test Support
 - Aerospace
 - Range
- Trainers and Simulators
- Quartermaster Type Equipment
 - Cleaning and Sanitation Equipment
 - Food Preparation Equipment
 - Personal Care Equipment
 - Shelters
- Fuels, Lubricants and Propellants
 - Exotic Fuels
 - Hydraulic Fluids
 - Rocket Propellants
 - Fusion
 - Hybrid
 - Isotope
 - Liquid
 - Monopropellant
 - Nuclear
 - Solid
 - Toxic Fuels
- Industrial Processes (bonding; cutting; fixtures; forming; finishings; gauges; inspection instruments; joining methods; packaging; preserving; tools; treatment; welding)
- Instrumentation
 - Aircraft
 - Electronics
 - Manometers
 - Missiles
 - Laboratory
 - Optical
 - Potentiometers
 - Range
 - Transducers
- Materials
 - Ablatives
 - Chemicals
 - Metallurgy and Metallics
 - Non-metallics
- Mathematics and Computation
- Medicine and Biology
 - Air Evacuation
 - Allergy
 - Anatomy
 - Aviation Medicine
 - Bacteriology
 - Biochemistry
 - Biomedical Aspects of Special Weapons
 - Biophysics
 - Dentistry
 - Dermatology
 - Entomology
 - Epidemiology
 - Immunology
- Military and Field Medicine
 - Neurology
 - Neuropsychiatry
 - Ophthalmology
 - Orthopedics
 - Otorhinolaryngology
 - Parasitology
 - Pathology
 - Pharmacology
 - Physiology
 - Preventive Medicine
 - Radiobiology
 - Radiology
 - Surgery
 - Toxicology
 - Veterinary Medicine
 - Virology
- Meteorology
 - Atmospheric Hydrodynamics and Circulation Temperature
 - Balloon Probing and Transport System
 - Micrometeorology
 - Synoptic Techniques
 - Winds, Turbulence and Diffusion
- Military Psychology
 - Intelligence Operations Techniques
 - Psychological Warfare Methods
- Missiles
 - (Subdivide as required: air to air; air to surface; air to underwater; surface to air; surface to surface; surface to underwater; underwater to air; underwater to surface; underwater to underwater.)
 - Alighting Gear
 - Components, Accessories and Parts
 - Design
 - Electrical Equipment
 - Instruments
 - Launching and Recovery Equipment
 - Mechanical Equipment
 - Stability and Control
 - Test Vehicles
- Navigation and Navigation Instruments and Equipment
 - Ground Reference Navigation
 - Distance and Position Finding
 - Radar Beacons and Markers
 - Radar Search
 - Navigation Instruments
 - Astrograph Data Boards
 - Chart Projection Methods
 - Chronometers
 - Computers
 - Driftmeters
 - Octants

- Self-Contained Navigation
 - Celestial
 - Celestial-Inertial
 - Inertial
 - Position Indicators
- Terminal Control of Air Vehicles
 - Air Traffic Control
 - Ground-Controlled Approach
 - Homing
 - Instrument Landing Systems
- Vehicle Guidance and Control
 - Beam Riding
 - Command Systems
 - LORAN
 - Radio Compass Auto-pilots and Coupling to Beams
 - SHORAN
- Parachutes (Cargo; ballute decelerator; hyperflo chute; missile recover; personnel theory of)
- Personnel Utilization
 - Assignment, Evaluation, Promotion
 - Human Engineering
 - Manpower
 - Psychology of Training
 - Psychophysiology
 - Training and Education
- Photography (Including Aerial Reconnaissance Collection)
 - Interpretation and Compilation
 - Processes and Devices
 - Cameras
 - Emulsions
 - Optics
 - Processing
 - Schliren
 - Shadowgraph
 - Techniques
 - Infra-red
 - Micro
 - Three Dimensional
 - Ultra-violet
- Physics
 - Acoustics
 - Electricity and Magnetics
 - Experimental Physics
 - Lasers
 - Magnetohydrodynamics
 - Masers
 - Plasma Stream
 - Seeded Plasma
 - Mathematical Physics
 - Mechanics
 - Nuclear, Atomic, Molecular Structure
 - Solid State Physics
 - Thermodynamics
- Physics (Atmospherics)
 - Acoustics
- Cloud Physics and Nucleation
 - Cosmic and Solar Influences
 - Electricity and Ionization
 - Meteors
 - Optics
 - Radiation
 - Structure and Composition
- Sociology
 - Demography
 - Inter-group and Inter-personnel Relations
 - Morale and Leadership
- Space Technology
 - Astronautics
 - Operations in Space
 - Orbital Rendevous
 - Space Exploration
 - Spacecraft
 - Aerospace Planes and Components
 - Design and Construction
 - Satellites
 - Space
 - Capsules
 - Damage Assessment and Vulnerability Studies
 - Probes
 - Stations
 - Vehicles
 - Spacecraft Launch Vehicles and Ground Support
 - Handling and Launching (including transportation and storage)
 - Preparation for Launch, Countdown
 - Spacecraft Trajectories and Re-entries
 - Analysis
 - Determination
 - Orbital Calculations
 - Re-entry
 - Space Mechanics
- Special Weapons, Effects and Defense
 - Atomic Weapons
 - Bacteriology and Biological Warfare Agents
 - Chemical Warfare Agents (CW)
 - Radiological Warfare Agents (RW)
 - Thermonuclear Weapons
- Terrestrial Sciences
 - Geodesy
 - Geology
 - Geomagnetisms
 - Geophysical Aspects of Atomic Weapons
 - Oceanography
 - Seismology
 - Soil Mechanics
- SEC—SECURITY
 - Censorship
 - Classification Management
 - Classifying, Regrading, and Declassifying
 - Marking
 - Security Classification Guides

Counterintelligence
 Subversive Activities (See INV)
 Individuals
 Organizations

Personnel Security (See INV)
 Civilian Personnel
 Military Personnel
 Training, Indoctrination, and Education

Physical Security
 Control of Entry and Exit
 Guarding and Patrolling (Guarding
 and Patrolling Operations—see POL)
 Identification and Passes
 Physical Safeguards
 Barriers, Devices, and Equipment
 Visitor Control
 Travel Control
 Security of Materiel Movements (Supply)
 Security of Troop Movements (Personnel)

Safeguarding Classified Information
 Destruction
 Dissemination/Disclosure and Access
 Handling, Transmission, and Transportation
 Preparing, Reproducing, and Controlling
 Security Compromise and Administrative
 Deviations
 Storage and Safeguarding

SUP—SUPPLY AND SERVICES

Budget/Buy/Requirements (Subdivide by appropriation, as required by activity)

Commodities
 Airspace
 Communications
 Munitions

Facilities
 Construction
 Methods
 Storage
 Utilization

Services
 Clothing Sales
 Commissary Operations
 Food Services
 Menus
 Laundry and Dry Cleaning
 Mortuary and Grave Registration
 Escorts and Honors
 Headstones and Markers
 Interments and Disinterments
 Post Exchange Operations
 Supply Policy/Procedures AFM 67-1
 Volume I, Part One
 Chapter One

Volume I, Part Two
 (Further subdivided as required to indicate divisions of AFM 67-1 utilized by the activity)

Systems Management
 Data Automation Proposals
 Effectiveness Reports
 Equipment Management
 Projects

TNG—TRAINING

Administrative Training and Facilities (Schools)
 Administrative Procedures
 Management Training
 Secretarial Training

Air Academy
 Civilian Components
 Air Force Reserve
 Air National Guard
 Civil Air Patrol

Education Services
 Group Study
 Operation Bootstrap
 USAFI
 Veterans Administration In-Service Program

Flying Training and Facilities (Schools)
 Basic
 Bombardment
 Fighter
 Instrument
 Ground Control Approach (GCA)
 Instrument Landing (ILS)
 Navigation
 Reconnaissance
 Rotary Wing
 Tactical

Foreign Trainees

General Military Training
 Code of Conduct
 Disaster Actions and First Aid
 Physical Conditioning
 Security
 Small Arms Marksmanship

Military Training (Non-Flying)
 Basic Training
 Officer Training

Professional and Academic Training and Facilities (Schools)
 Academic
 Chaplains
 Dental
 Legal
 Medical

Technical Training and Facilities (Schools)

- Field Training
- On-the-Job Training
- Skill Training
 - Support Training
 - Systems Training
- Special Training
- Training Programming

Training Aids

- Equipment
- Materials

Unit Training

TRS—TRANSPORTATION

Cargo

- Air
- Land
- Sea

Equipment and Facilities

- Facilities
- Materials Handling Equipment
- Railroad Equipment
- Utility Boats

Military Air Transport

- Ferrying of Aircraft
- Integration of Commercial Facilities
 - Charters
 - Contracts
 - Ground Detention
 - Regulations (Operating Rights, CAB Proceedings, etc.)

- Lost or Destroyed Aircraft (Cargo and/or Personnel in)

Monthly Reports

- Channel Requirements
- Movement Reports
- SAAM Requirements

Nonrevenue Traffic

- Cargo
- Mail
- Passengers
 - Civilian
 - Dependent
 - Military
 - Retired, Reserve, ROTC

Revenue Traffic

- Cargo
- Passenger

Special Projects

Traffic Regulations

- Capabilities and Allocations
- Clearances
- Documentation
- MAP Traffic
- NATO Traffic
- UN Traffic

Military Motor Vehicles

- Base Authorized Allowances
- Bus Movements
- Drivers Qualification and Training
- General Purposes
 - Administration
 - Tactical
- Operations
- Special Movement Authorizations
- Special Purpose
- Tolls.

Military Sea Transport

Billing Procedures (MSTS)

Cargo

- Outturn Reports
- Overseas Destination
 - England
 - Germany
 - Others
- Special Cargo
 - Aircraft
 - Privately Owned Automobiles
- Z. I. Ports
 - HRPE
 - NOPE
 - NYPE
 - SEPE
 - SFPE

Monthly Reports (MSTS)

- Monthly Requirements
- Movement Reports
- Special Requirements

Passengers

- Civilian
- Dependent
- Military
- Retired Personnel
- Space Available

Port Detachments

Stevedoring

Movement Control (Priorities)

Packaging—Marking

- Dangerous Materials
- Marking
- Packaging—Preservation
- Packing
- Unitization

Passenger

- Commercial
- Military
- TPA

Personal Property

- Household Goods and Unaccompanied Baggage
- House Trailers
- POVs

Petroleum, Oil, and Lubricants (POL)

IMMEDIATE ACTION

CHANGE

AFM 181-4A

AIR FORCE MANUAL
NO. 181-4A

DEPARTMENT OF THE AIR FORCE
Washington, 2 November 1966

Records Management

MAINTENANCE OF CURRENT RECORDS

AFM 181-4, 3 October 1966, is changed as follows:

1. Pen and Ink Changes:

Page	Paragraph	Line	Action To Take
✓5	✓7b	✓12	Change "contact" to "contract."
✓8	✓8a(2)	✓9-13	Change example as shown below: <div style="display: flex; justify-content: space-around; align-items: flex-start;"> <div style="text-align: center;"> <p><u>Consecutive Sequence</u></p> <p>12 34 56</p> <p>↑ ↑ ↑</p> </div> <div style="text-align: center;"> <p><u>Terminal Digit</u></p> <p>12 34 56</p> <p>↑ ↑ ↑</p> </div> </div>
✓14	✓10a(2)	✓7	Change "subjectively arranged" to "general correspondence."
✓18	✓Figure 4	✓Upper right corner	Change the figure as shown below: <div style="border: 1px solid black; padding: 5px; display: inline-block; margin: 10px;"> <p>ADM 3 X 6B</p> <p style="margin-top: 10px;"><i>File adm</i></p> </div>
✓27	✓24g(3)	✓2	Change "deck" to "desk."

2. Filing. After making the above changes, file this change sheet in back of the manual.

BY ORDER OF THE SECRETARY OF THE AIR FORCE

OFFICIAL

J. P. McCONNELL
General, U.S. Air Force
Chief of Staff

R. J. PUGH
Colonel, USAF
Director of Administrative Services

DISTRIBUTION: F; X: National Personnel Records Center (Military),
9700 Page Blvd, St. Louis, Mo. 63132 25
Federal Records Center, Cameron & Union Streets, Alexandria, Va. 22314 10

AFDASS

23 Jan 1967

Maintenance of Mission Correspondence Files (Your Ltr, 6 Jan 1967)

USAFCS (CAS-4)

1. Maintenance procedures for correspondence files were simplified in the current edition of AFM 161-4 because of numerous complaints. Mostly, the complainants said (a) it was impractical for records clerks to distinguish between permanent and temporary documents, (b) it resulted in at least one more place to search for a document, and (c) the volume of temporary documents did not warrant the additional filing costs necessary to segregate the documents. On the basis that the primary purpose of filing is to quickly and economically file and find documents and that the ultimate disposition of the records (while important) is secondary, we decided to return to the former system of maintaining permanently all mission correspondence files at major subordinate command levels and above.

2. Screening records to remove unwanted or unnecessary papers is a costly files operation and normally exceeds any related savings in records storage costs. For this reason, "screening" is not authorized in AFM 161-4.

3. We believe, however, that eliminating unnecessary records is important when the cost is justified. Based on problems peculiar to your command and because the records will be screened, in any event, for security reasons, your command is authorized to eliminate temporary documents when preparing correspondence files for staging. Use paragraph 050101b, AFM 161-5, as disposal authority.

FOR THE CHIEF OF STAFF

WILLIAM R. BOUCHER
Chief, Documentation Systems Division
Directorate of Administrative Services

CHAP 1

OBJECTIVES

~~OBJECTIVES~~ AND RESPONSIBILITIES
~~GENERAL~~

Apr 110-10--

Para 16 - "Custodian. A person in charge of an office in which official A.F. records are filed by law, regulation, or custom; a person so designated by proper authority; and for certain purposes, a person who has physical possession of official AF records for use in his official duties."

CHAP. 2

PLANNING AND ARRANGING FILES

CHAP. 3

FILES PROCEDURES

para 14 b -- last sent -- chg "9d" to
"9e"

CHAP. 4

FILING SUPPLIES & EQUIPMENT

AF SUBJECTIVE
CLASS, MASTER
OUTLINE

~~DATE LISTING REQUIREMENTS~~

DEPARTMENT OF THE AIR FORCE
WASHINGTON DC 20330AIR FORCE LETTER
NO. 181-4

22 August 1966

SUBJECT: Conservation of Equipment and Space Occupied by Records

TO: (Distribution: S).

Expires 31 December 1966 unless sooner rescinded or superseded.

1. Purpose. This letter implements a Presidential directive and General Services Administration (GSA) regulation, imposing on all Federal agencies, a moratorium on the purchase of filing cabinets. It applies to all activities Air Force-wide.

2. Background. The President's moratorium is intended to attain the more effective use of office space and equipment used for maintaining records through procedures which will insure the prompt retirement or destruction of records no longer required for conducting current business. To this end, prerequisite actions are required as justification for the procurement of filing cabinets.

3. Security Filing Cabinets. While the President's moratorium does not apply to GSA tested and approved security filing cabinets required for the safeguarding of classified information by AFR 205-1, the requirements of paragraphs 4 and 5 apply to requisitions for such equipment.

4. Action Required:

a. Commanders will require that all requisitions for letter- and legal-size filing cabinets be reviewed by a records officer (appointed in accordance with AFR 181-1) to insure that the office requesting the filing cabinets has taken the following actions:

(1) All records are identified on AF Forms 80, "Files Maintenance and Disposition Plan," and 82, "Files Disposition Control Label," and maintained in accordance with AFM 181-4.

(2) All temporary records eligible for destruction in accordance with disposal criteria in AFM 181-5 have been destroyed.

(3) All noncurrent records not eligible for destruction have been retired to the records staging area or records center in accordance with the instructions on AF Forms 80 and 82.

(4) Filing cabinets are being fully used for current records, including top and bottom drawers.

(5) The contents of filing cabinets have been re-housed in more economical equipment such as shelf files in accordance with guidelines prescribed by chapter 5, AFM 181-4.

This letter supersedes AFL 181-4, 11 March 1965.

OPR: AFDASB

(6) All security filing cabinets not being used for classified material have been exchanged for nonsecurity type of filing cabinets.

b. If the office requesting the filing cabinet has complied with all of the prerequisites prescribed in a above and the additional filing cabinet is needed, the records officer will so certify on the requisition. He will then forward the requisition to the supply activity for necessary action.

5. Collateral Policies and Actions:

a. Requests for filing cabinets normally will be limited to essential requirements arising from new or materially expanded offices.

b. Filing cabinets will not be requested solely for the purpose of improvement in appearance, office decor, status elevation, or desire for the latest design or more expensive types.

c. The requisition and use of power files or other unconventional filing equipment solely as a basis for circumventing this moratorium is prohibited.

d. All filing cabinets turned-in as a result of actions required by paragraph 4 and the office space released by such actions will be reported as cost reduction items according to AFM 400-12 if they meet the applicable criteria. See action 3, chapter 3, AFM 181-5, 1 July 1963, as amended, for calculation guidelines.

BY ORDER OF THE SECRETARY OF THE AIR FORCE



R. J. PUGH
Colonel, USAF
Director of Administrative Services

RECORDS MANAGEMENT

**MAINTENANCE
OF
CURRENT RECORDS**

20 FEBRUARY 1960

THIS REPRINT DATED 26 DECEMBER 1963 CONTAINS THE BASIC MANUAL
AND CHANGES A AND B.

FOREWORD

1. ~~Purpose and Scope.~~ This manual implements ~~AFR 181-1.~~ It prescribes policies, procedures, and techniques for the maintenance of current records. It is designed to show records management personnel and records custodians how to establish basically uniform, economical, and efficient practices for maintenance of current records. While this manual stresses the maintenance of subject files, it also prescribes records maintenance procedures that are applicable to all types of records. These procedures include:

- a. Establishing proper locations for maintaining records (offices of record).
- b. Assigning duties and responsibilities for records maintenance.
- c. Using and controlling filing supplies and equipment.
- d. Applying filing practices and techniques.

2. *Applicability.* This manual is applicable to all Air Force activities. It will be effective when received. However, files established according to procedures of the superseded manual may be maintained according to those procedures until new files are established. The new files will then be maintained according to this manual from that time on.

3. *Purpose of Revision.* This manual changes procedures, adds new information, and revises subjects in the major subjective categories. The greatest number of subject changes have been made to the major subjective categories of Financial Management, Mapping and Charting, Administrative Management, and Training (formerly Military Training). Office Services have been deleted and Office Administration has been added. Custodians of records will review the text and the Master Outline in Appendix A, prior to establishing a new set of files.

4. *Supplemental Instructions.* The issuance of supplemental instructions to interpret and apply these basic policies and procedures to organizations or types of records peculiar to certain Air Force activities is authorized. Supplementary directives or manuals which alter basic policies or merely reiterate or duplicate the text of this manual are prohibited.

5. *Changes to Manual.* Recommended changes with supporting reasons will be forwarded to the Director of Administrative Services, Headquarters USAF, ATTENTION: Records Management Group, Washington 25, D. C. 20330

6. *Distribution.* Distribution of this manual is not restricted to the activities named or in the quantities indicated. Additional copies are avail-

This manual supersedes AFM 181-4, 4 September 1953, 20 Feb 1958, as amended, and AFL 181-4, 11 Mar 1965

HQ USAF (AF)

181-4

stated

able through publications distribution channels and may be requisitioned by any element or activity of the Air Force having a legitimate need for them.

7. *Supply of Forms.* Forms prescribed in this manual will be requisitioned through publications distribution channels.

BY ORDER OF THE SECRETARY OF THE AIR FORCE:

OFFICIAL:

THOMAS D. WHITE
Chief of Staff

J. L. TARR
Colonel, USAF
Director of Administrative Services

This manual contains no copyright material.

DISTRIBUTION:

F;X:

Air Force Records Center, 9700 Page Blvd., St. Louis 14, Mo.	25
Federal Records Center, GSA, King and Union Streets, Alexandria, Va.	10
Military Assistance Advisory Groups	1
Air Force Sections of Missions	1

CONTENTS

	<i>Paragraph</i>	<i>Page</i>
CHAPTER 1. CURRENT RECORDS—CUSTODY AND RESPONSIBILITY		
Why Records and Efficient Records Maintenance Practices Are Necessary	1	1
Where Records Will Be Located	2	1
Office of Record	2a	1
Role of the Office of Record	2b	1
Determining Factors for Locating Offices of Record	2c	1
Duties and Responsibilities	3	2
Records Management Officers	3a	2
Records Officers	3b	2
Records Custodians	3c	2
CHAPTER 2. BASIC FILING ARRANGEMENTS		
Planning Files	4	3
Basic Filing Arrangements	5	3
Subject Arrangement	6	3
Numerical Arrangement	7	4
In Consecutive Numerical Sequence	7a	4
By the Terminal Digit Method	7b	4
Chronological Arrangement	8	5
Geographical Arrangement	9	5
Organizational Arrangement	10	5
Alphabetical Arrangement	11	6
Case Filing	12	6
Use of Copyright Indexing and Filing Systems	13	7
CHAPTER 3. THE AIR FORCE SYSTEM FOR THE ARRANGEMENT OF RECORDS BY SUBJECT		
What This Chapter Contains	14	8
The Air Force Subjective Classification System	15	8
Introduction	15a	8
Major Subjective Categories	15b	8
Subdivisions	15c	8
Rules for Using the Subjects in the Master Outline	15d	9
File Codes	15e	9
Relative Index	15f	9
File Outline	15g	10
Classifying Correspondence	16	11
Cross-Referencing	17	14
Subject Cross-Referencing	17a	14
Name Cross-Referencing	17b	14
Continuity Cross-Referencing	17c	15
Cross-reference Designation	17d	15
Preparation of Cross-Reference Sheets	17e	15
CHAPTER 4. FILES PROCEDURES		
What This Chapter Contains	18	16
Coordination of Filing Procedures to Facilitate Disposition of Records	19	16

	<i>Paragraph</i>	<i>Page</i>
General Policy	19a	16
Correspondence Files	19b	16
Transitory Records	19c	17
Small Collections of Records	19d	18
Filing Security-Classified Records	20	18
Preparation of Documents for Filing	21	18
Assembling Correspondence for Filing	22	19
Letter with No Indorsements	22a	19
Letter with Indorsements	22b	19
Filing Date	22c	19
Connecting Related Papers	23	19
Fastening Practices	24	19
Preparation and Use of Guides and Folders	25	19
Guides	25a	20
Folders	25b	20
Positions of Guides and Folders	25c	21
Labeling Cabinets	26	21
Sorting	27	22
Methods	27a	22
Equipment	27b	23
Use of Charge-Out Form	28	24
Files Cutoff Procedures	29	24
Purpose	29a	24
General Policy	29b	24
 CHAPTER 5. FILING SUPPLIES AND EQUIPMENT		
Objectives	30	25
Standard Filing Cabinets	31	25
Letter Size	31a	25
Legal Size	31b	25
Standard Filing Supplies	32	25
Folders	32a	25
Guides	32b	25
Labels	32c	26
Forms	32d	26
Utilization Standards for Filing Equipment	33	26
Procedures for Control of Filing Equipment	34	26
Open Shelf Filing	35	27
What Open Shelf Filing is	35a	27
When it Should be Used	35b	27
General Comparisons with Filing Cabinets	35c	27
Guide for Comparison	35d	27
 APPENDICES:		
A—Air Force Subjective Classification System.....		29
B—Rules for Alphabetical Arrangement.....		71

Illustrations

	<i>Figure</i>	<i>Page</i>
Conventional Numerical Arrangement	1	4
Terminal Digit Numerical Arrangement	2	5
Chronological Arrangement	3	6
Geographical Arrangement by State	4	6
Organizational Arrangement	5	6
Alphabetical Arrangement	6	7
File and Cross-Reference Designation	7	12
DD Form 334, Cross-Reference Sheet	8	13

	<i>Figure Paragraph</i>	<i>Page</i>
Example of Mission and Office Administration Correspondence File	9	14
Disposition of Correspondence File	10	17
How to Assemble Basic Letter and Inclosures, with no Indorsements, for Filing	11	19
How to Assemble Basic Letter with Indorsements, Inclosures, and Re- lated Material for File	12	20
Subject File Arrangement Showing Guides and Folders with Major Subjective Categories in the First Position	13	21
Subject File Arrangement Showing Guides and Folders with Major Subjective Categories and Primary Subdivisions in the First Position	14	22
Correspondence Sorter	15	23
Rack Sorter	16	23
Square Cut, Reinforced Top Folder	17	25
One-Third Cut, Self-Tab Pressboard Guide	18	26

Chapter 1

CURRENT RECORDS-CUSTODY AND RESPONSIBILITY

O.K.
1. Why Records and Efficient Records Maintenance Practices are Necessary

Records play a vital role in the management and operation of Air Force activities. They serve as the memory of the organization, a record of past events, and the basis for future actions. Records maintained systematically will be complete, easily accessible, and properly arranged to serve their purpose at present, as well as requirements of the future. Eliminating duplicate and unnecessary records will reduce the expense of handling, and the cost and amount of supplies, equipment, and office space to maintain them. Locating records properly within the organization is most important to allow full utilization and to eliminate duplication of current records.

2. Where Records Will Be Located

Current records will be maintained by those elements designated by the organization commander as offices of record.

a. Office of Record. ~~Commanders will establish offices of record at organizational levels where effective documentation of assigned functions and responsibilities can be assured.~~ *Records will be sufficiently accessible to the using activities to preclude the maintenance of duplicate files. The office of record will be assigned responsibility for the custody and maintenance of the permanent and temporary current records of the offices it serves. Records maintained by offices of record will be complete. They will include correspondence, with related inclosures, and records of other series required*

to document the responsibilities of the offices served; and those required in the performance of their functions. Although offices of record have actual custody of records, the records management officer and records officers will exercise staff supervision to insure proper records maintenance in accordance with paragraph 3.

b. Role of the Office of Record. *Properly* Established offices of record will place records in the custody of the offices that have primary interest in the subject matter documented by the records, and the primary need to use the files. Consequently, the functions and responsibilities of the office served by the office of record are segregated and completely documented. For example: an office of record responsible for some specific aspect of "Military Personnel Administration," such as "Personnel Services," will have in its custody all the documents and records pertaining to that function. Such an office has expert knowledge and an intimate view of its functions and responsibilities, and can best determine documentation and reference requirements. The files thus organized and maintained will serve the needs of the office most effectively, and the segregation of permanent records from temporary and transitory documents will be easier.

c. Determining Factors for Locating Offices of Record:

(1) The maintenance of duplicate records (convenience files) by offices served by offices of record is prohibited. ("Reading files" as described in AFM 181-5 are a separate series of records and are not considered

OK
Consolidate to 1 - highest design that will preclude duplicate files
attachment

duplicate "correspondence files.") Locate the office of record so that the need for duplicate files by the offices served thereby is eliminated.

(2) Locate the offices of record at the point of greatest activity for convenience of the users. If the records of an organizational element are normally used only by that element, it should be designated as the office of record.

(3) Avoid centralizing the records of activities unrelated by organization in one office of record. The maintenance of records by the activity primarily concerned with the subject matter makes files more useful, improves documentation of functions, and facilitates disposition of the records.

★3. Duties and Responsibilities

a. *Records Management Officers* appointed in accordance with ~~paragraph 5b~~, AFR 181-1, ~~2 October 1953~~, will:

(1) Exercise staff supervision over the program to insure that the policies and procedures prescribed in this manual are being complied with throughout the command, and that ^(b) corrective action is taken when required.

(2) ⁽²⁾ Indoctrinate and train records officers in the application of current records maintenance procedures.

2 (3) Coordinate and adjust ^{command} records maintenance practices to insure adequate documentation and to facilitate the disposition of records.

3 (4) ^{and economic} Insure the full utilization of equipment ^{supplies} and space for the purpose of keeping records.

b. *Records Officers* appointed in accordance with ~~paragraph 5b~~, AFR 181-1, ~~2 October 1953~~, are responsible for monitoring the program at their headquarters and its constituent elements. Specifically, the records officer will serve as a consultant to

records custodians and records clerks in carrying out the provisions of this manual. He will be responsible for insuring that records custodians receive adequate indoctrination and that records clerks receive adequate training. He will ~~make periodic staff visits to offices of record under his jurisdiction to insure that all records are properly identified on AF Form 80, "Files Maintenance and Disposition Plan," and that correct disposition instructions are prescribed on AF Form 82, "Files Disposition Control Label." (See paragraph 10b, c, and d.)~~ He will also review all requests for filing equipment to insure ^{proper} utilization in compliance with paragraph 84.

c. *Records Custodians* are officials, ^{in charge of} administratively responsible for an organizational element which ^{are} has been designated as an "office of record." They also are responsible for the maintenance and disposition of the records and for the proper use of filing equipment in their custody.

d. *Records Clerks* are individuals who have been assigned the duty of maintaining and servicing the files in an office of record. To do this job effectively, the records clerk must:

(1) Know the functions of the office for which the records are maintained.

(2) Know what purpose the records are to serve and adjust the filing practices accordingly, so that accurate and efficient reference service can be furnished the users of the file.

(3) Know and apply the records maintenance and disposition procedures applicable to the records he maintains.

(4) Consult with the records custodian and, when necessary, with the records officer regarding problems affecting the maintenance and disposition of records.

(5) ~~Always maintain a neat and orderly file.~~

(6) Prepare AF Forms 80 and 82.

appropriate
delegated

References to records officers in this manual include those persons assigned the duties of a RO on a part-time basis

Include OPR for the records only prescribe their own filing systems as long as they follow basic filing arrangements in AFM 181-4. If the system is otherwise common, we will include it in this manual.

Chapter 2

BASIC FILING ARRANGEMENTS

4. Planning Files

The files of an office of record may consist of one or more "records series." A "records series" is a group of documents arranged and maintained to serve a specific purpose, and identified by a name or designation which indicates the function the group of documents performs as a file of "records." The first planning step is to determine what groups of documents accumulated by the office of record should be maintained in separate records series. In making this determination, consider the following:

a. *Reference Requirements.* The need for frequent, easy reference to a particular group of documents may necessitate that the documents be organized and maintained as a separate series of records.

b. *Volume of Records.* A large group of records serving the same purpose and being of the same kind is indicative that it should be maintained as a separate series of records.

c. *Physical Nature.* Non-standard size records as card files, large maps and charts, rolls of film, tape recordings, etc, because of their size and shape will preclude their combination with ~~paper~~ records. Accordingly, they are segregated and filed separately from ~~paper~~ records.

d. *Ultimate Disposition.* Unless it would impair reference, records with different retention periods should be filed as separate series of records to eliminate screening, and facilitate disposition.

5. Basic Filing Arrangements

After considering which records are to be filed as separate series of records, a method

of arranging each series of records must be selected. The method selected should permit ease of filing and finding; and preclude the use of separate indexing systems, whenever possible. A system for the subjective arrangement of correspondence files is included in Appendix A. That system is not intended for the arrangement of all Air Force records. Filing procedures for a specific series of records are frequently incorporated in the directive that prescribes the records. However, when records are accumulated which are not appropriate for filing in a file of general correspondence, or for which specific filing instructions are not prescribed, one of the basic sequence methods for the arrangement of records specified below should be selected:

- Numerical
- Chronological
- Geographical
- Organizational
- Alphabetical

Whenever one basic sequence method is used for the primary arrangement, one or more other sequence methods can be used in subdividing or arranging the records within the framework of the primary arrangement. For example, records filed by subject are further arranged by date. Similarly, records arranged geographically may be subdivided organizationally. Subsequent paragraphs of the Chapter contain a description of the filing arrangements and criteria for their use.

6. Subject Arrangement

This is the term used to describe the arrangement of files by categorical topics and

See Army Manual

Delete

subject

then by related subjects within each topic. Although there are many types of documents than can be arranged effectively by subject, this arrangement is most frequently used for arranging correspondence. Each office of record will normally have a separate correspondence file. This correspondence file will consist of originals, carbon copies, or other reproduced copies of letters, indorsements, memoranda, and related inclosures; and electrically transmitted messages. This correspondence invariably involves a wide variety of subjects and as a consequence can best be identified and used if arranged by subject. The prescribed system for the subject arrangement of Air Force correspondence is the Air Force Subjective Classification System found in Appendix A. Procedures and techniques for the application of the System are found in Chapters 3 and 4. Because of the practice of some activities to file in the correspondence file all the records they create or accumulate, examples of the types of records that are not appropriate for maintenance as a part of the correspondence file are cited below. They are more effectively maintained as separate series of records.

a. (1) Record sets and reference collections of publications which are arranged by type of publication and chronologically and/or numerically under those types.

b. (2) Control type records, such as index cards, locator cards, mail control records, document receipts, etc.

c. (3) Records with a short retention time, such as locator files of messages, filed by "cite" number and/or geographical location, and transitory and reading files arranged chronologically.

d. (4) Case files, such as civilian and military individual personnel records, and claims and contract case files.

e. (5) Specific series of records for which a separate directive prescribes for their maintenance such as numerical and functional forms files, bills of lading files, supply records, etc.

f. (6) RCS Reports.

7. Numerical Arrangement

This system is used to arrange records that are normally identified and referred to by number as bills of lading, requisitions, purchase orders, etc. Other records, such as accounting documents, are more useful if arranged by allotment number, etc.

(Note: As a general rule, with the exception of subject codes, numbers should not be assigned documents for the sole purpose of arrangement for filing. This practice requires the establishment of additional indices to locate the documents.)

There are two methods for arranging records numerically:

a. *In Consecutive Numerical Sequence.* This is the conventional method illustrated in Figure 1;

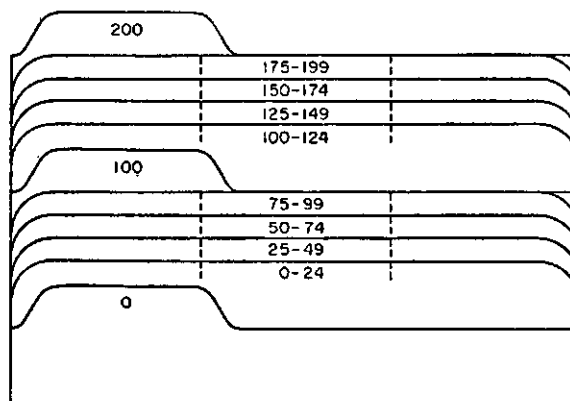
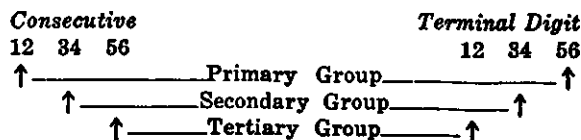

Figure 1. Conventional Numerical Arrangement (Par 7a)

b. *By the Terminal Digit Method.* Under this method, numbers are read from right to left and arranged in groups. Consideration should be given to the adoption of this system when documents to be filed numerically have gaps in their numerical sequence, are comprised of five or more digits and consist of 25,000 or more card records or individual documents or 10,000 case folders. The basic difference in reading a six figure number is illustrated below:



Under this system, records are arranged according to (1) The last two or three digits; then (2) By the secondary group, and (3) By the last group. Illustrated below is a sample arrangement using the conventional and terminal digit arrangement:

Conventional	Terminal Digit				
	Primary only	Primary and Secondary			
32200	322 00	97 13 00			
365348	9713 00	3 22 00			
453648	6153 02	61 53 02			
615302	3653 48	45 36 48			
971300	4536 48	36 53 48			

This system speeds sorting and filing, reduces errors caused by transposition of numbers, and permits a better distribution of the work load. Figures 2a and 2b illustrate the various possible terminal digit filing combinations.

8. Chronological Arrangement

This system is used to arrange documents in date sequence when the date is the primary means of reference. It is the most useful method for keeping documents in small, manageable groups, usually by year, month, and day. Chronological arrangement

is frequently used in conjunction with other systems. Transitory, reading, and suspense files are examples of records which are generally arranged by date. Figure 3 illustrates a suspense file that is arranged chronologically.

9. Geographical Arrangement

This is a file arrangement by geographical locations such as area, country, state, county, etc. It is used when the geographical location is of primary importance in referencing records. The file is arranged in alphabetical sequence first by the name of the main geographical division, such as a "state," then by the next most important subdivision required for reference purpose such as "counties," "cities," or "names of bases." Figure 4 illustrates a geographical filing arrangement by state.

10. Organizational Arrangement

This file arrangement is used when the grouping of documents by the name of the *pertinent* organization is of primary importance in referencing records. Organiza-

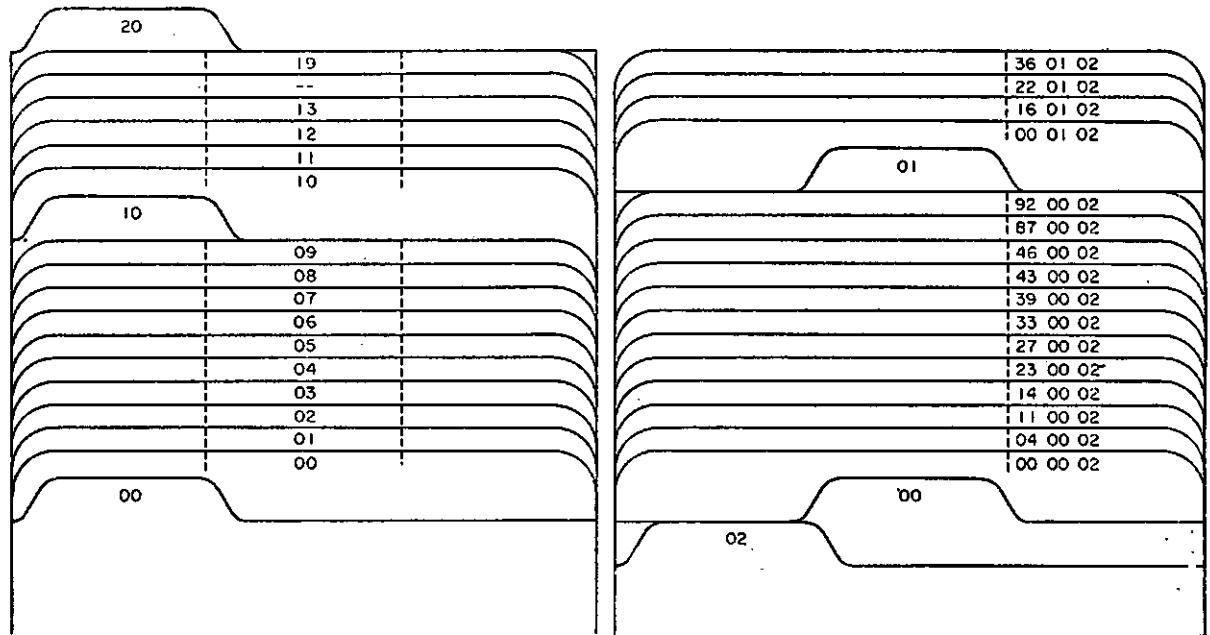

Figure 2. Terminal Digit Numerical Arrangement (Par 7b)
 2a. Using Primary Groups Only 2b. Using Primary and Secondary Groups

tional arrangement is fundamentally an "alphabetical" arrangement of organizations as they relate to each other. They are arranged by particular levels of command and subdivided by subordinate elements arranged alphabetically and numerically by the designations of the organizations. If both name and number organizational des-

ignations are filed in the same group, the names will be filed in front of the numbers. (See Figure 5.)

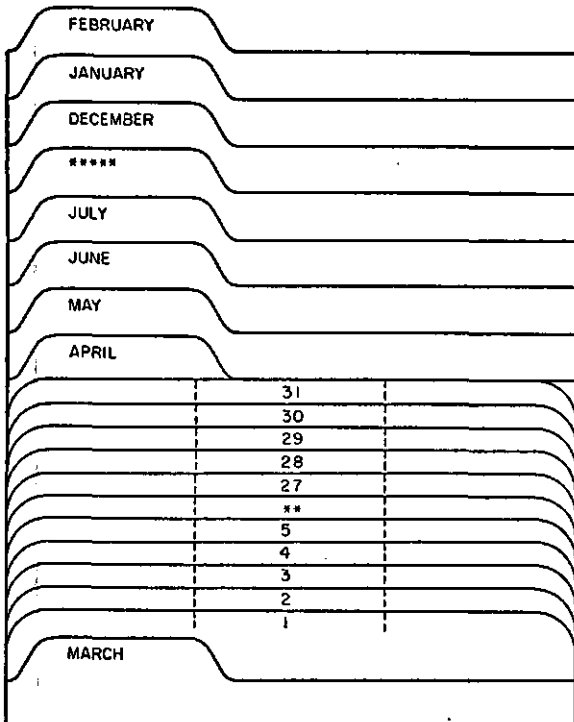

Figure 3. Chronological Arrangement (Par 8)

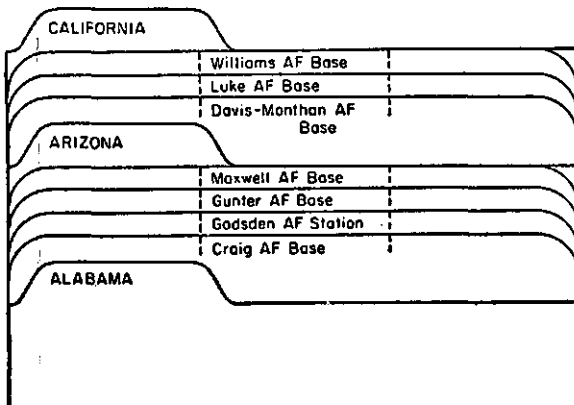

Figure 4. Geographical Arrangement by State (Par 9)

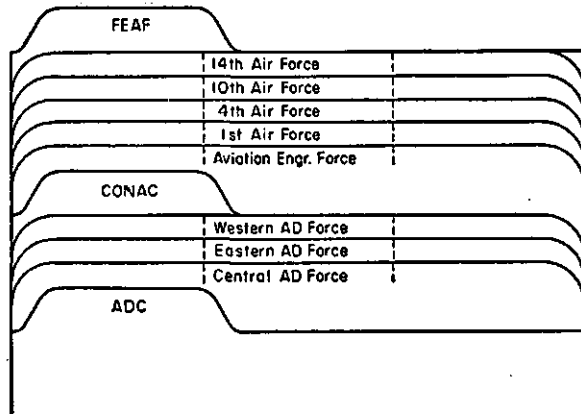

Figure 5. Organizational Arrangement (Par 10)

11. Alphabetical Arrangement

This arrangement is used to file documents by name of persons, companies, agencies, etc., in alphabetical order. It is used when the name is of primary importance in referring to the records. Because names comprise more than one word and frequently include initials and descriptive words, rules for filing them alphabetically will be consistent. Rules for alphabetical filing of names are found in Appendix B. Figure 6 illustrates samples of alphabetical filing arrangements.

12. Case Filing

This method of filing is the grouping of documents that pertain to a particular person, place, or thing. A case file may consist of correspondence and other documents, all of which pertain to the same person, place, or thing. The case file differs from a subject file in that the subject file consists of the documents collected on separate transactions, all of which pertain to a *general* subject; while the individual documents in the case file pertain to a *specific* subject; such as a particular person, place, or thing. Case files are also distinguished from subject files

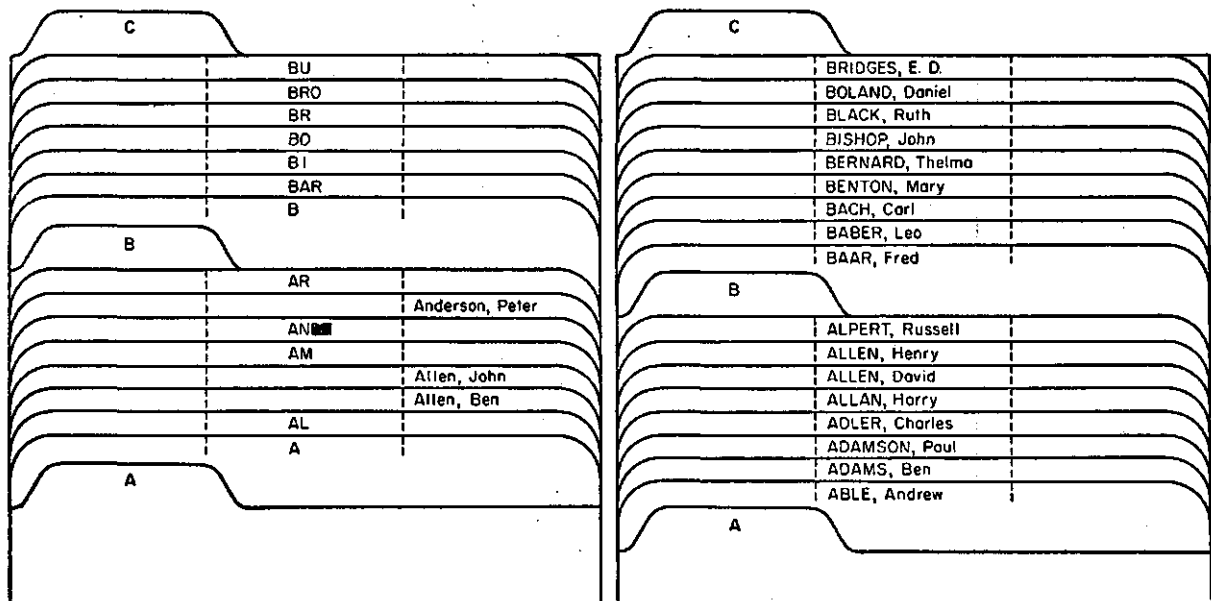

Figure 6. Alphabetical Arrangement (Par 11)

6a. Consolidated and Individual Files

6b. Individual Files

in that subject files are terminated annually while the termination of a case file is contingent upon an event, such as final payment of a contract, completion of a project, termination of employment, etc. For these reasons, case files are generally filed as a separate series of records under any of the arrangements mentioned above as may be appropriate. However, small groups of case files may be maintained in the correspondence file as a subdivision of the general subject. For example, the general subject of microfilming may be subdivided by case files, each file pertaining to a specific microfilming project. In this case, the general subject folder would be cut off annually but the case files would be brought forward to the current year's file until the particular

project was completed. Papers within each case file are generally arranged in chronological order, with the most recent paper placed at the front of the folder.

13. Use of Copyright Indexing and Filing Systems

The use of indexing or filing systems that have been copyrighted by the manufacturer is prohibited, without prior approval of Hq USAF. Approval will be requested from the Director of Administrative Services, Headquarters USAF, ATTENTION: ~~Records Management Group (AG-215-8)~~, giving a description of the system to be used, the name of the manufacturer and the records to be maintained thereby.

*Will consider deletion
if you permit
the case files
to remain filed*

Patented

*See patent by proprietary rights or
Change*

Chapter 3

THE AIR FORCE SYSTEM FOR THE ARRANGEMENT OF RECORDS BY SUBJECT

CORRESPONDENCE

14. What This Chapter Contains

This chapter contains a description of the Air Force Subjective Classification System for the arrangement of correspondence by subject. The classification system, consisting of a master classification outline of Air Force subject matter and a relative index thereto, will be found in Appendix A.

15. The Air Force Subjective Classification System

a. *Introduction.* It has been said that: "the best system ever devised is only as good as the persons that use it." This means, of course, that in order for a "system" to accomplish the purposes for which it is designed, the persons that use it must understand thoroughly what it was designed to do and how to apply it. The Air Force Subjective Classification System has been designed to:

- (1) Arrange and group correspondence and related documents by the Air Force *function* to which their *subject* pertains;
- (2) Provide subject arrangement of correspondence and related documents so that they can be filed and found quickly and easily; and
- (3) Enable Air Force activities to separate, simply and quickly, those portions of the file that must be retained from those that should be disposed of promptly.

Since the system is designed to group the subject matter of documents by the *function* to which they pertain it can be described as a "functional classification system." With that idea in mind, all of the functions per-

formed by Air Force activities have been grouped into twenty-five (25) broad categories which are referred to in the system as "major subjective categories" or "major subjects."

b. *Major Subjective Categories.* The "major subjective categories" are listed in Appendix A, together with a list of the most common specific subjects that comprise each of the major subjective categories. Each of the twenty-five (25) major subjective categories represents a group of specific but related functions and related subject matter. The addition of other major subjective category titles is not authorized. The meaning and scope of each major subjective category is explained in Appendix A.

c. *Subdivisions.* Each of the major subjective categories is subdivided by related subject matter. These subdivisions are referred to as primary, secondary, tertiary, and further subdivisions. When the primary subject is rather broad in scope and includes matters frequently identified as separate functional subjects, a list of such subjects is provided. These subjects are referred to as "secondary subdivisions," or "secondary subjects." Similar lists of related subjects are added to the secondary subdivisions and tertiary subdivisions. The complete list of subjects is referred to as the "master outline" for it is, in fact, an "outline" of the broad functions performed by Air Force activities, a majority of the specific functions of which they are comprised, and how they are related to each other. The "master outline" in this manual is intended only as

a *reference guide* for establishing a "subject file" that will meet the specific requirements of the user and to show the proper relationship of specific subjects to the major subjects and to each other. Subjects not specifically provided for in the master outline may be added. *To permit flexibility and simplification of the filing system, secondary and further subdivisions may be used as primaries when they represent the primary function of the activities served by an office of record.* It must be noted that the titles represented as subdivisions are subjects and do not indicate that the record itself will be filed there. For example, MIL 7, "Military Personnel Records" is used to group correspondence on the subject of Military Personnel Records. The personnel records groups or individual personnel files are filed as a separate series of records and not in the correspondence file.

d. *Rules for Using the Subjects in the Master Outline.* It must be borne in mind that the Air Force Subjective Classification System is designed to meet the many and varied requirements for "subject files" that exist throughout the Air Force. It is not intended that the master outline of subjects be used in its entirety for a single set of files. The master outline will be used only as the *basis for establishing a file*, using only as much of the "master outline" as is necessary to meet the reference requirements of the user and volume of documents that will be placed in the file. If the suggestions below are borne in mind in applying the system and its procedures, a simple and effective subject file will result.

(1) If the volume of records accumulated under a major subjective category is small, use only the major subjective category and, if necessary, certain selected primary subdivisions.

(2) Subdivide subjects only when experience indicates that a specific aspect of the subject is referred to frequently, and the volume warrants a separate subdivision.

(3) When the volume of documents in a subject folder reaches the capacity of the folder (three-quarters of an inch) and it is

not necessary to subdivide it in accordance with (2) above, add another folder on the same subject, identified by the inclusive dates of the documents within each folder.

e. *File Codes.* File codes are a combination of letters and numbers that represent a particular subject.

(1) Subjects are assigned file codes to facilitate identification for classifying, sorting, and filing. In this classification system the coding system consists of a three-letter symbol for each of the 25 major subjective categories and number(s) representing the subdivision, if used. With only a few exceptions, the symbol clearly suggests the subjective title it represents. For example, CIV means Civilian Personnel Administration, and MGT means Administrative Management. A list of the symbols is contained in appendix A.

(2) As indicated in g(2), below, subdivisions are arbitrarily assigned a number in the sequence in which they were established on the initial file outline. Dashes are used to separate the numbers. Examples of file codes representing major subjective categories and primary, secondary, and tertiary subdivisions are illustrated below:

Major Subjective Category	CIV
Primary	CIV 1
Secondary	CIV 1-1
Tertiary	CIV 1-1-1

f. *Relative Index.* The index in appendix A is an alphabetical listing of specific subjects, indicating the related major subjective category or subdivision in the Master Outline, Air Force Subjective Classification System. The relative index shows the proper relationship of specific subjects to the major subjects and to each other. It will assist the user of the system to classify documents properly for filing. For example, MIL 2 indicates that the subject of "Assignment of Military Personnel" is related to the major subjective category, MILITARY PERSONNEL ADMINISTRATION. The subject, "Temporary Duty Assignment" is MIL 2-8 which indicates that this subject is related to MIL 2, "Assignment of Military Personnel." Note that the index also in-

cludes titles and terms synonymous with subjects listed in the Master Outline. It is not necessary to compile a separate relative index for the file outline of the files of an office of record (see g, below). However, a notation on the file outline of the inclusion of unusual subjects in a major subjective category or subdivision thereof is frequently very useful. It is again emphasized that the numerous subjects that make up the Master Outline and the Relative Index are to be used only to the extent necessary to establish a file in the most simple form that will meet the requirements of the office of record.

g. General Correspondence Files Outline.

(Note: The "file outline" (subjective classification outline) for general correspondence files has been made a part of AF Form 80, "Files Maintenance and Disposition Plan," described in paragraph 19c. Do not prepare a separate general correspondence "file outline." Pending a complete revision of this manual, all references to "file outline" will be interpreted to refer to that portion of AF Form 80, which describes the subjectively arranged general correspondence file. Accordingly, the following instructions for maintaining these files will continue to apply.) Use the "master outline" as a basis for establishing a "file outline." Subjects not specifically provided for in the "master outline" may be added to the "file outline" as required. The "file outline" is prepared on AF Form 80. (See paragraph 19c.)

(1) In preparing the file outline, select the major subjective category or categories that represent the subject matter areas dealt with by the offices served by the office of record. Use only the minimum of subdivisions warranted by volume of correspondence. (add)

(2) In numbering the primary, secondary, and further subdivisions, do not use the numbers in the master outline, but assign your own numbers in sequence, under each major subjective category, as illustrated below. In the illustration, a group of subjects from the major subjective category, MILITARY PERSONNEL ADMINISTRATION, is used. If subjects are added

after initial compilation of the file outline, merely assign the next number in sequence.

MIL 1 Assignment and Reassignment
2 Discipline-Conduct
3 Pay and Allowance
4 Promotion and Demotion

(added) 5 Identification

Secondary numbers will be assigned in sequence under each primary subdivision as illustrated below:

MIL 1 Assignment and Reassignment
1-1 Attached
1-2 Permanent Change of Station
1-3 Temporary Duty
(added) 1-4 Flying Status

(3) Consecutive numbering is not required in secondary or further subdivisions that are subdivided by a numbering system from another publication. To illustrate: When the supply class numbers listed in AFM 67-1 are used as subdivisions of MTN, the classification numbers will be used as assigned in the supply manual: for example, MTN 4 (14), (15), and (25).

(4) Avoid setting up folders that will contain only one or two papers.

(a) Subdivide major and primary subjects only when experience indicates that a specific subdivision of the major subjective category is needed for reference, ~~or to segregate records that have different retention periods.~~

(b) Do not use a subdivision merely because a few pieces of paper are accumulated on a specific subject, or anticipate the use of subdivisions, unless experience indicates their need.

Example A illustrates further an elaborate subdivision that may be consolidated to provide adequate subject coverage, and yet will result in making and searching fewer folders. (See example B.)

Example A:

MED 4	Hospital and Dispensary Administration
4-1	Capacity and Status
4-2	Clinical Records
4-3	Patient Management
4-3-1	Admission and Disposition
4-3-1-1	Discharge
4-3-1-2	Leave
4-3-1-3	Transfer

Example B:

MED 4	Hospital and Dispensary Administration
4-1	Capacity and Status
4-2	Clinical Records
4-3	Patient Management

In the above example, it was assumed that only a few papers were accumulated on each subdivision of MED 4-3. Therefore, to avoid making four folders that would contain only a few papers each, these papers were consolidated under MED 4-3. It is best to let experience dictate the need for subdividing each subject.

(5) The terms "general" and "miscellaneous" will not be used, since generalization is provided throughout the system. Using example A, above, as an illustration; a letter pertaining to Hospital and Dispensary Administration, but not specifically to subjects 4-1 thru 4-3, would be classified under MED 4. Similarly, a letter pertaining to Patient Management, but not specifically to the subdivisions thereof, would be classified MED 4-3.

(6) ^{Original} ~~copy~~ of AF Form 80, "Files Maintenance and Disposition Plan," ~~including superseded plans~~ will be maintained in front of the ~~current general correspondence~~ files. It is not necessary to retire a copy of the plan with files retired to the records staging area because the AF Form 42, "Records Shipment List," contains sufficient detail to facilitate search. (Note: ~~"File Outlines" superseded by the system described in paragraph 19b will be maintained and retired with the general correspondence accumulated before adoption of this system.~~)

★ 16. Classifying Correspondence

Classifying is the process of determining the subject matter of the document; the major subjective category that represents that subject matter; the specific subdivision to which it pertains, if needed; and the file code that should appear on the paper.

Subject matter is classified in accordance with the file outline prepared for the office of record. In determining the classification of a letter, the classifier should read the body of the letter since the "subject line"

does not always represent the actual subject, or may lack sufficient identifying information. In the process of classifying documents, the classifier must also determine the need for cross-referencing as discussed in paragraph 17 and illustrated in figures 7 and 8. After the appropriate classification is determined, place the file code on correspondence in the upper right corner as illustrated in figure 7. Papers will be coded only after action has been completed and papers have been authorized for file. (See paragraph 21a.) A few general rules to be followed in classifying by the Air Force Subjective Classification System are discussed below:

a. The subject of a document may have a different meaning or significance to the individual activities involved in the exchange of correspondence. Therefore, the subject of the document should be classified on the basis of its pertinence, interest, or significance to the functions and operations of the activity for which the document is maintained. For example, to an Operations Office, the subject "Use of Air Bases" may mean suitability of the base from the standpoint of its use for strategic bombing operations and the document would be classified accordingly, under OPS-1. To an Installations Office, the subject may concern the engineering problems involved in maintaining the airfields, and therefore, it would be properly classified under INS-1. Similarly, documents that refer to an item of supply, or the action of a board or committee, should be classified on the basis of the subject matter they concern and on the basis of their pertinence and significance to the function of the office for which the records are maintained. For example, a letter about an item of supply would be classified under MTN, SUP, or R&D depending upon whether the letter concerned the maintenance of the supply item, the distribution of the item, or the performance of research and development on the item. Likewise, reports, if not filed as a separate series of records, should be filed by the subject of the report. For example, Records Management Reports are filed under MGT-1, Documentation and Records Management, and not under MGT-10.

From AFM 181-4B includes classifying procedure for separate series - 5/27/53-66 19/5/60

Department of Supply, sub. of factory info, it deleted

consider breaker... for file... Open copies... to Colson file

30 August 1961

DEPARTMENT OF THE AIR FORCE
HEADQUARTERS UNITED STATES AIR FORCE
WASHINGTON 25, D.C.



*Right 1-1
KCIW 11-2
file
20*

*Copy to
illustrations
only / may
category 7*

REPLY TO
ATTN OF: AFCSS-CP-4

SUBJECT: Suggestion No. 1234 - Preparation of Correspondence

1 JUN 1961

TO: HQ USAF (AFCAS-8)

1. XXXX XXXXXXXX XXX X XXXX XXXXXX XXXX XXXXX XXXXXX XXXX XX

XXXX XXXXXXX.

2. XXXXXXXX XXXXXX XX XXX XXXXX XXXXX XXXXXXXX XXXXXX XXXX XXX

XXXXX.

XXXX XXXXXXXXXXXX
XXXXXXXXXX
XXXXXXXXXXXXXXXXXXXXXXXXXX
XXXXXXXXXXXXXXXXXXXXXXXXXXXX

Figure 7. File and Cross-Reference Designation (Par. 16)

DATE ~~15 Dec 57~~ 1 JUN 1961

INDEX: CIV 11-2

TO: AFCAS-8

FROM: Hq Committee on Civilian Awards

SUMMARY: Suggestion No. 1234 - Preparation of Correspondence

FILED: MGT 1-1

INDEXER: amd

REMARKS:

DD FORM 1 MAR 50 334

CROSS-REFERENCE SHEET

16-61293-1
U. S. GOVERNMENT PRINTING OFFICE : 1951-O-971013

*Illustrate / Major
category into 2*

Figure 8. DD Form 334, Cross-Reference Sheet (Pars 16 and 17)

b. Correspondence accumulated in the performance of the primary mission or functions of ~~the offices served by~~ the office of record, as opposed to those documents accumulated in the internal administration of the office, will be classified under the major subjective category or subdivision thereof that represents each such subject. (See Figure 9.)

c. Correspondence accumulated in the performance of the internal administration of ~~the offices served by~~ the office of record will be classified under the major subjective category OFFICE ADMINISTRATION, or appropriate subdivision thereof.

d. Correspondence, whether ~~it~~ concerns "mission functions" or "office administration" that are "transitory" in nature will be classified and filed as transitory material as explained in paragraph 19*af*.

17. Cross-Referencing

DD Form 334, illustrated in Figure 8, is placed in the files as a finding aid when reference is made to the actual document in more than one way. A copy or copies are

filed under one or more subjects as required, indicating where the actual document is filed. Judgment based on knowledge of the files and the manner of making references should determine the extent of cross-referencing. Elaborate cross-reference systems should not be established because, in isolated instances, a particular document is hard to find. Instructions for preparing the cross-reference form are contained in paragraph e, below. As a general rule, documents should be arranged in a manner which will preclude the necessity for cross-references, or any other additional "finding" system.

a. *Subject Cross-Referencing.* When two or more separate and distinct subjects are contained in a single document, classify and file the document under the primary subject, and cross-reference the other subject, or subjects, as required. The cross-reference designation will be made by the classifier at the time the initial coding is made. The designations are placed on documents as illustrated in Figure 7.

b. *Name Cross-Referencing.* Air Force

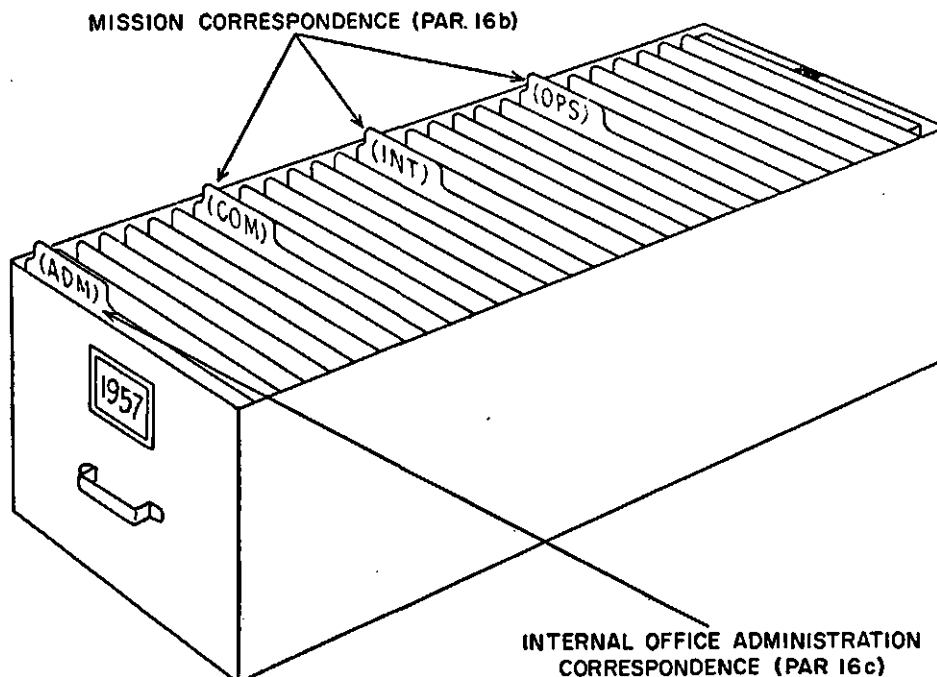

Figure 9. Example of Mission and Office Administration Correspondence File (Pars 16 b and c)

activities, conducting a large volume of correspondence with the general public, the Congress, or other government agencies, may find a "name index" useful in quickly locating correspondence filed by subject. When such an index is warranted, it will be maintained in front of the first drawer of the files to which it relates.

c. Continuity Cross-Referencing. This is the use of a cross-reference sheet describing a document brought forward from one folder to another and consolidated with related papers. The continuity cross-reference sheet is filed, replacing the document brought forward.

For example: a basic letter with 2 indorsements, filed under date of 21 Jun 60, may be brought forward and attached to another basic letter, dated 7 Jan 61, on the same subject and transaction. A cross-reference sheet is prepared and filed in place of the letter dated 21 Jun 60 to show that the letter has been placed in the files of the following year.

d. Cross-Reference Designation. File and cross-reference designations will be placed on the document as illustrated in figure 7. A check mark, drawn through the (x), will indicate that the cross-reference has been prepared. Names to be cross-referenced should be underlined. Place an (x) over the name after cross-reference has been made.

★*e. Preparation of Cross-Reference Sheets.* DD Form 334 (supplied in single sheets is used for this purpose (see figure 8).

(1) *Date.* Type date of correspondence or document being cross-referenced: day, month, and year (e.g., 1 June 1961). If no date is shown, insert "ND" and approximate date, or, date received.

(2) *Index.* List all subject and name cross-references which the classifier has

marked. If more than one reference is required, use additional DD Forms 334 as needed. This form is also used for "continuity cross-referencing."

(3) *To.* Enter name of individual or organization to whom the document is addressed.

(4) *From.* Indicate document originator.

(5) *Summary.* Enter subject line of document being cross-referenced. If further identification is needed, include names, serial numbers, sums of money, or other supplementary information.

(6) *Filed.* Enter file designation of the document. When a continuity cross-reference sheet is being prepared, place the new date (under which the correspondence will be filed) in parentheses after the file designation; e.g., MGT 1-1 (1 Jan 63).

★*f. Substitution of Copies for DD Form 334.* If an extra copy of the document to be cross-referenced is available, use it instead of DD Form 334. Also, use copies made on "fast copy" machines in lieu of DD Form 334 when facilities are conveniently located.

(1) *When Extra Copies Are Used.* Mark extra copy as illustrated in figure 7. Circle file designation to indicate where the extra copy is to be filed as a cross-reference.

(2) *When Fast Copies Are Used.* Mark the record copy (as illustrated in figure 7) before making fast copies of it. Circle file designation, on the copy, to indicate where it will be filed as a cross-reference.

(3) *Continuity Cross-Reference.* When using extra or fast copies for continuity cross-reference, write (in parentheses) the new date under which the document is filed (as described in subparagraph e(6) above).

Chapter 4

FILES PROCEDURES

18. What This Chapter Contains

This chapter contains instructions for:

- a. Filing to facilitate disposition of records.
- b. Maintaining classified records.
- c. Preparing and assembling correspondence for file.
- d. Using guides and folders.
- e. Labeling guides, folders, and cabinets.
- f. Charging out documents from the file.
- g. Fastening papers.
- h. Sorting records.
- i. Cutting off files after prescribed periods of time or upon occurrence of a specific event.

19. Adaptation of Filing Procedures To Facilitate Disposition of Records

★a. *General Policy.* Planning for records maintenance has 2 objectives:

- (1) To arrange records to meet current reference requirements.
- (2) To identify and group series of records to facilitate systematic disposition authorized by AFM 181-5.

Arrange files to make it easier to destroy or retire them. *For example:* arrange files to permit periodic retirement or disposal of each records series in complete blocks (see figure 10). Do not interfile records having different retention periods.

★b. *Consolidated Files Maintenance and Disposition System.* AF Forms 80 and 82,

"Files Maintenance and Disposition Plan," and "Files Disposition Control Label," are the 2 basic elements of this system. These forms (described in c and d below) replace AF Forms 296 and 296a, "Records Control Schedules," and "Continuation Sheet," and the general correspondence files outline. Records control schedules, superseded by this system, will be retained as long as needed.

c. *Files Maintenance and Disposition Plan:*

(1) *Purpose.* AF Form 80, "Files Maintenance and Disposition Plan," will be prepared by each office of record (see figure 10a). It identifies all records for which an office has responsibility—both general correspondence files and other separate series of records. When used with labels (described in d below), this form provides a comprehensive and efficient system for maintaining and disposing of records.

(2) *Preparation.* Both sides of AF Form 80 will be used and prepared (in duplicate) as follows:

(a) *Column 5A.* Start with number 1 and consecutively number each series of records on the "Plan."

(b) *Column 5B.* Enter a brief, precise description of each series of records, using title of the applicable paragraph of AFM 181-5. If necessary for series identification, list various documents in the series. Occasionally, the local title of a series differs from AFM 181-5. In such instances, add the local title immediately after title used in the manual. (NOTE: If a group of records is not identified in AFM 181-5, use a brief title that is descriptive of the file and its function.) When identifying general correspondence files, list the "mis-

*When preparing
the plan, use
the title of the
series as it
appears in
the manual.
If a group of
records is not
identified in
the manual,
use a brief
title that is
descriptive of
the file and
its function.*

revised to delete from

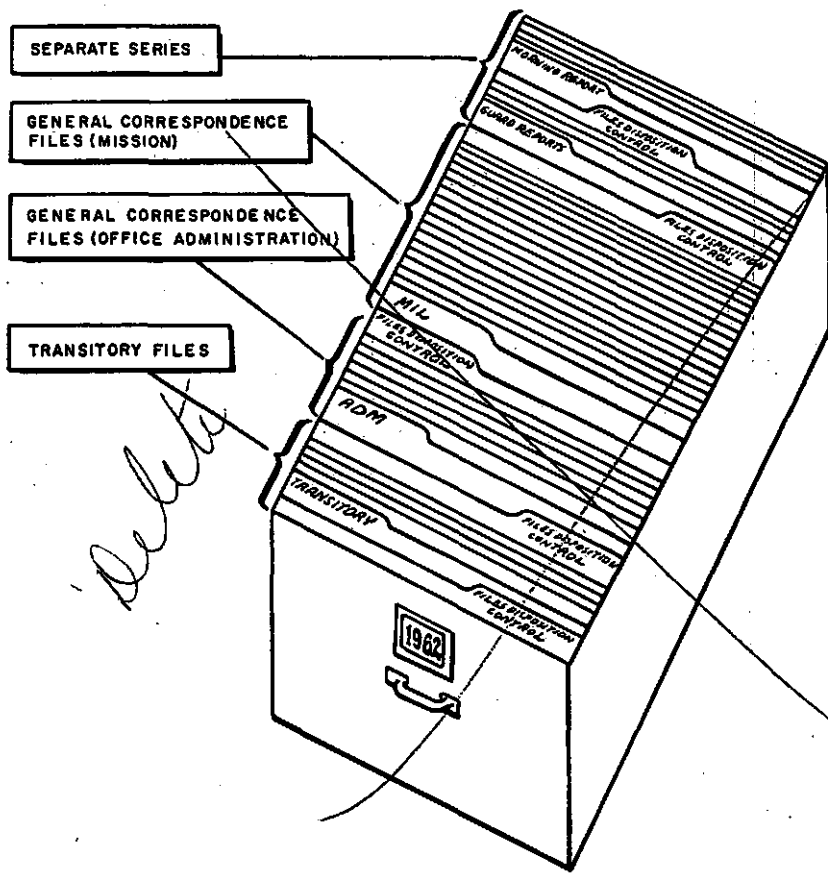

delete

ch. To more clearly reflect purpose of affecting block diagram of how following series

Figure 10. File Drawer Illustrating Placement of AF Forms 82

FILES MAINTENANCE AND DISPOSITION PLAN		DATE PREPARED 1 August 1963	
1. OFFICE SYMBOL OF OFFICE OF RECORD OR UNIT DESIGNATION Office of Safety		2. PREPARED BY (Name of records clerk) John Jones	
3. TYPED NAME AND POSITION TITLE OF RECORDS CUSTODIAN Richard Roe Assistant Director of Safety		4. SIGNATURE OF CUSTODIAN	
5. FILES PLAN			
ITEM NO.	TITLE OR DESCRIPTION OF RECORDS SERIES	FILED ARRANGEMENT OF EACH SERIES (Subjectively, numerically, alphabetically, etc.)	DEPOSITION (Insert number of paragraph and sub-paragraph in AFM 181-5. If paragraph can not be found, enter "None.")
1	FILES MAINTENANCE AND DISPOSITION PLAN (AF FORM 80)	Front of Files	160303a
2	ROUTINE TRANSITORY RECORDS	Chronological	050102
3	GENERAL CORRESPONDENCE FILES (Office Admin) ADM OFFICE ADMINISTRATION 1 Administration of Office Personnel 2 Budgeting	Subjective	050101a(2)
4	GENERAL CORRESPONDENCE FILES (Mission) INV INVESTIGATIONS AND INSPECTIONS 1 Safety Programs 1-1 Flight Safety 1-2 Ground Safety	Subjective	050101a(1)
5	GROUND ACCIDENT SUMMARIES	Chronological	120310
6	GROUND ACCIDENT REPORTS	Chronological	120312
7	AIRCRAFT ACCIDENT AND/OR INCIDENT REPORTS	Alphabetical	120311

AF FORM 80 Aug 61

Figure 10a. Files Maintenance and Disposition Plan (Policy Making Office).

sion" and "office administration" portions of the file as separate items (see figure 10a). Then list specific subjects making up each portion of the file (see paragraph 15g and figure 10a). On the form, list records series in the sequence that best suits the needs of the using office.

(c) *Column 5C.* Self-explanatory.

(d) *Column 5D.* Enter paragraph and subparagraph numbers of AFM 181-5 prescribing disposition of the records. If a paragraph covering disposition of the files cannot be found, enter "None," and advise the records officer.

(3) *Distribution.* AF Form 80 original will be retained by the office of record. Forward the copy to the responsible records officer for review and use in monitoring maintenance and disposition of records concerned.

(A) *Review.* Preparation of AF Form 80 is a one-time job. However, periodically review and amend the form to insure that all files are accounted for and that cited disposition authorities are appropriate. Records officers will be notified of any corrections, deletions, or additions. Reaccomplish AF Form 80 only when further corrections or additions cannot be made.

(5) *Standardization of AF Form 80.* Some lower echelon activities (such as base exchange units) accumulate, maintain, and dispose of like records in the same way. In such cases, standardization of AF Form 80 will save time and money. Proposed standard AF Form 80 will be approved by the command records management officer before using activities prepare and distribute them.

d. *Files Disposition Control:*

(1) *Purpose.* AF Form 82, "Files Disposition Control Label" (see figure 10b), is printed on special paper stock which adheres to file guide cards when moistened with water. Affix this form to tabs of guide cards preceding each record series to facilitate block disposition of records. This identifies records filed behind each guide card and prescribes their ultimate disposition (in accordance with authorities from AFM

← Fold line

# GPO : 1961 OF - 810246	
1. TITLE OR DESCRIPTION OF RECORDS, SERIES	
3. GENERAL CORRESPONDENCE FILES (Office Admin- istration)	
2. PARAGRAPH NO. FROM AFM 181-5 050101a(2)	
3. CUT-OFF INSTRUCTIONS 31 December	
4. DISPOSITION INSTRUCTIONS Destroy after 1 year.	
FILES DISPOSITION CONTROL LABEL	
AF FORM Aug 61 82	REPLACES AF FORMS 296, JAN 57 AND 296A, JUL 54 WHICH MAY BE USED UNTIL 1 JAN 63.

Figure 10b. Files Disposition Control Label.

181-5 cited on the related AF Form 80). These guide cards and labels are "disposition guide cards," as distinguished from "locator guide cards" described in paragraph 25. Do not use both "locator" and "disposition" guide cards in front of a records series because the disposition guide card also serves as a locator guide card.

(2) *Use:*

(a) *Placement of Disposition Guide Cards:*

1. Use a first (left) position disposition guide card to identify files to be transferred to the records staging area.

2. Use a second (center) position disposition guide card to identify files to be forwarded directly to a records center by the office of record (such as morning reports, personnel folders, etc.).

3. Use a third (right) position disposition guide card to identify files to be destroyed in the current files area.

It is important that all records following a guide card have the same retention period. These cards will remain with cut-off files

as long as they are retained in the current files area. (See figure 10 for examples.)

(b) Replacement or Reuse of Cards:

1. Make new sets of cards as needed for current accumulations of each records series.

2. When non-current records series are retired or destroyed, reuse the disposition guide cards for current accumulations.

(c) Exceptions:

1. When it isn't feasible to affix AF Form 82 to a guide card and place the guide card in front of a record series, affix the label to the container housing the records. When the series of records is housed in more than one container, affix the label to the first container.

2. Do not prepare AF Forms 82 for records maintained for a period of time but never placed in filing equipment (such as a safe check record or a room security inspection record). Instead, describe the records on AF Form 80 and enter disposition instructions immediately below the description.

(3) Preparation:

★(a) *Item 1 (Title or Description of Record Series)*. Insert appropriate item number from AF Form 80, "Files Maintenance and Disposition Plan," and paragraph title from AFM 181-5 followed by the local title, if any. *NOTE:* When volume justifies, item number from AF Form 80 may be used to code papers for filing in series other than correspondence files. *(See para —)*.

(b) *Item 2 (Paragraph Number from AFM 181-5)*. Enter applicable paragraph number of AFM 181-5. If no paragraph is applicable, enter "None."

★(c) *Item 3 (Cut-off Instructions)*. Indicate day and month (omit year to permit reuse of disposition guide card) or event when records will be cut-off as prescribed in paragraph 29, AFM 181-4.

(d) *Item 4 (Disposition Instructions)*. Enter following information, as appropriate:

1. If series has a short retention

period, and, can be held in available space and equipment in office of record until eligible for destruction, enter the word "Destroy" followed by the retention period (e.g., Destroy 6 months after cut-off).

2. If the series is "permanent," or, subject to a long retention period, enter the words "^{Retire}Transfer to Staging Area" or "Retire to Records Center," (as appropriate) followed by the period of retention in the office of record (e.g., "^{Retire}Transfer to staging area 2 years after cut-off"). Then, if records are temporary, give additional retention period (e.g., "Destroy after 3 additional years."); if records are permanent, so indicate. If disposition instructions are too lengthy for inclusion in this block, enter statement: "See AFM 181-5."

3. If no disposition instructions have been published enter "None." If instructions are published later, cross out "None" and enter applicable instructions.

★e. *General Correspondence Files*. These are subjectively arranged files of letters, messages, memoranda, and related documents accumulated by most offices of record. Maintenance of such files under the Air Force Subjective Classification System provides for segregation of "mission" documentation from "non-mission" (or housekeeping papers) at time of filing. This is accomplished by filing correspondence pertaining to the mission (functions and responsibilities) of the office of record under the appropriate major subjective category chosen from appendix A of this manual. All other correspondence is arranged subjectively in the "Office Administration—ADM" category as "non-mission" to the office accumulating them. Arrange correspondence files as follows to facilitate disposition:

(1) *HQ USAF, Major Air Commands, and Certain Major Subordinate Air Commands Having Policy Making Responsibility*

(a) *Mission "Managerial" Correspondence*. Correspondence files at these levels documenting Air Force or command-wide policy making, program monitoring, and implementation of policies from higher

24 February 1964

authority, are permanent records as provided in paragraph 050101a(1), AFM 181-5. They should be identified as a separate records series on the AF Form 80. (Correspondence accumulated by major command staff offices pertaining to functions for which they have command-wide responsibility is an example of such material.)

(b) *Mission "Operational" Correspondence.* Many offices at these levels also accumulate mission correspondence of temporary value. (Correspondence accumulated by major command staff offices pertaining to local implementation of Air Force and command directives by their immediate headquarters is an example of such correspondence.) It may be destroyed after 1 year as provided in paragraph 050101b, AFM 181-5, and should be identified as a separate item on the AF Form 80.

(c) *Non-mission Correspondence.* This category is also accumulated at these higher headquarters. It should be identified as a separate item on the AF Form 80 and disposed of after 1 year as provided in paragraph 050101a(2), AFM 181-5.

(2) *All Other Organizational Levels.* For records disposal purposes, there is no need to differentiate between "mission" and "non-mission" correspondence at these levels since both groups of correspondence are disposable after 1 year. Accordingly, identify correspondence files at these levels as 1 item on the AF Form 80 and cite paragraph 050101b, AFM 181-5, as the disposal authority.

(3) *Correspondence Filed With Other Records Series.* Correspondence relating to forms or other documents filed as separate.

series of records should be filed with such documents. For example, correspondence that relates to a specific bill of lading should be filed with the bill of lading. If this is done, the correspondence can be disposed of without screening at the same time the bill of lading is disposed of.

f. *Transitory Records:*

(1) Offices will generally accumulate correspondence and other documents that are of transitory value only. They include original and informational copies of documents that do not contain procedural or policy matter applicable to the receiving office, that do not require action by the receiving office, that involve a routine transaction, or that do not contain information of continuing reference value. They may also consist of letters of transmittal, communications correcting reports or other minor corrections to records, and requests for routine information, publications or supplies. The elimination of this material simplifies filing, because there are fewer papers to code, sort, and file subjectively. This also permits faster reference to important papers; and eliminates the need to screen the transitory material when records are disposed of.

(2) Transitory records that have served their purpose should be destroyed immediately rather than filed. However, if it is believed that they will be of reference value for 90 days or less, they will be filed in a folder labeled "Transitory" in date order regardless of subject and maintained as a separate series of records.

g. *Small Collections of Records.* In many instances, an office will accumulate small collections of records that are identified as separate series of records in AFM 181-5. To overcome the problem of different retention periods, it is suggested that the following action be taken unless reference to the records would be impaired:

(1) File in the transitory file those records eligible for disposal within 90 days.

(2) Records that are disposable contingent upon supersession or obsolescence (except publications), for example, records

control schedules, office policy memorandums, etc., can be filed in the correspondence file but "flagged" to indicate that they must be brought forward into the current file each year.

(3) Records with retention periods of 2 years or less may be maintained as a part of correspondence files which are disposable after 2 years and destroyed when the latter files become eligible for destruction.

(4) Records disposable in 1 year or less should be maintained on a calendar or fiscal year basis and destroyed 1 year after annual cut-off.

★19.1 Policy or Precedence Files

These files consist of *extra copies* of selected documents that reflect policies, precedents, procedures, and instructions that govern the performance of the mission and the operation of the office. They are used as a "ready" reference in conducting daily business and as a means of indoctrinating new personnel. They must be maintained on a current basis as a separate series of records. Since the documents in the file are few in number, they can usually be maintained in a single folder or binder. The file is kept current on a continuing basis by replacing superseded documents, removing obsolete documents, and adding new documents.

★20. Filing Security-Classified Records

Handle classified files in accordance with AFR 205-1.

File classified records separately, *except* when it is necessary to maintain the ~~distinction~~ and continuity of a particular transaction or event, or the volume of unclassified material is too small to justify setting up separate files. ~~In such cases,~~ indicate on the folder ~~tab~~ the highest classification of the records filed therein. Otherwise, the label and file designations should be the same in all other respects as the folders containing unclassified material. *Folders containing classified material must be filed in cabinets of the type authorized for each*

see AFCS & SC copy

205-1
205-1
205-1

classification. If folders containing classified material are to be filed with unclassified material, place the classified folder directly behind the folder containing unclassified material of the same type. When classified and unclassified material are filed in the same file cabinet and additional filing space is needed, the classified and unclassified folders will be segregated and filed in separate cabinets to avoid having to purchase additional security equipment. When a classified document is to be added to a voluminous file that has been unclassified before, the following action is recommended: substitute a cross-reference sheet for the classified document and file the classified document separately in available security equipment. Do not include any classified information on the cross-reference sheets that are to be filed in an unclassified file.

21. Preparation of Documents for Filing

In preparing documents for filing:

a. Insure that documents have been authorized for filing by the word "file" and initials of the authorizing official have been written on them as illustrated in figure 7. However, certain documents, such as retained copies of outgoing correspondence, are to be filed because there is evidence that they have been signed and dispatched. These copies, therefore, do not require the word "file" and initials.

b. Remove rubber bands, paper clips, pins and other temporary fasteners.

c. Determine that the file is complete and all inclosures are retained, or are accounted for.

d. See that parts of another file are not accidentally attached.

e. Mend, or reinforce with *scotch* tape, all torn or frayed papers.

f. Destroy identical duplicate copies, except the "originals" and "coordination" or file copies of correspondence.

g. Remove all copies of mail control forms and receipts; classified cover sheets; and memo routing slips, except those containing remarks of significant record value.

See note
★22. Assembling Correspondence for Filing

Arrange file copies of correspondence in the sequence described below. This arrangement is identical to the arrangement prescribed for dispatch of correspondence in AFM 10-1.

a. *Letter With No Indorsement (See Figure 11):*

(1) Arrange in numerical sequence with first of two or more pages on top.

(2) Arrange attachments in numerical sequence, following the basic letter.

b. *Letter With Indorsements (See Figure 12).*

(1) Arrange correspondence as follows:

(a) Place the latest indorsement on top of basic letter. All other indorsements follow the basic letter in numerical sequence.

(b) Arrange attachments in numerical sequence and place at the bottom of the file.

(2) Arrange the pages as follows:

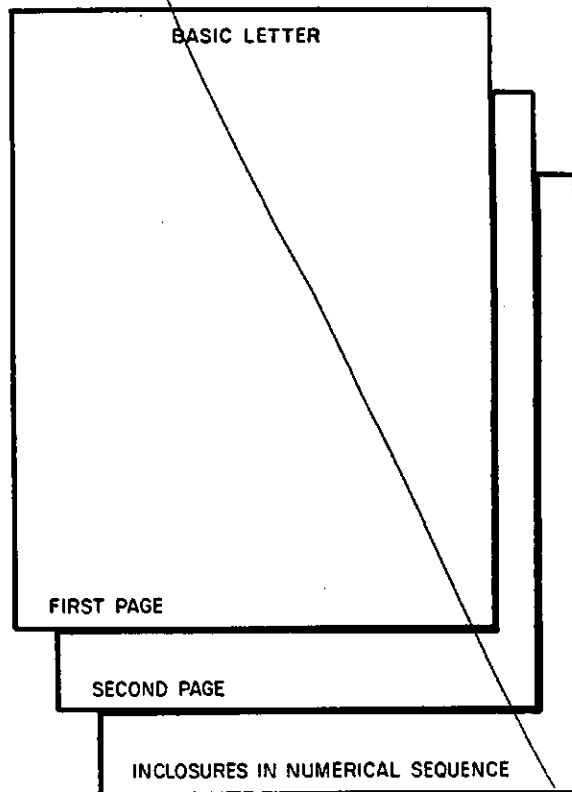

Figure 11. How To Assemble Basic Letter and Attachments with No Indorsements for Filing (Par 22)

Assemble with coms for filing in some manner as specified for dispatch in AFM 10-1. File by date of latest indorsement.

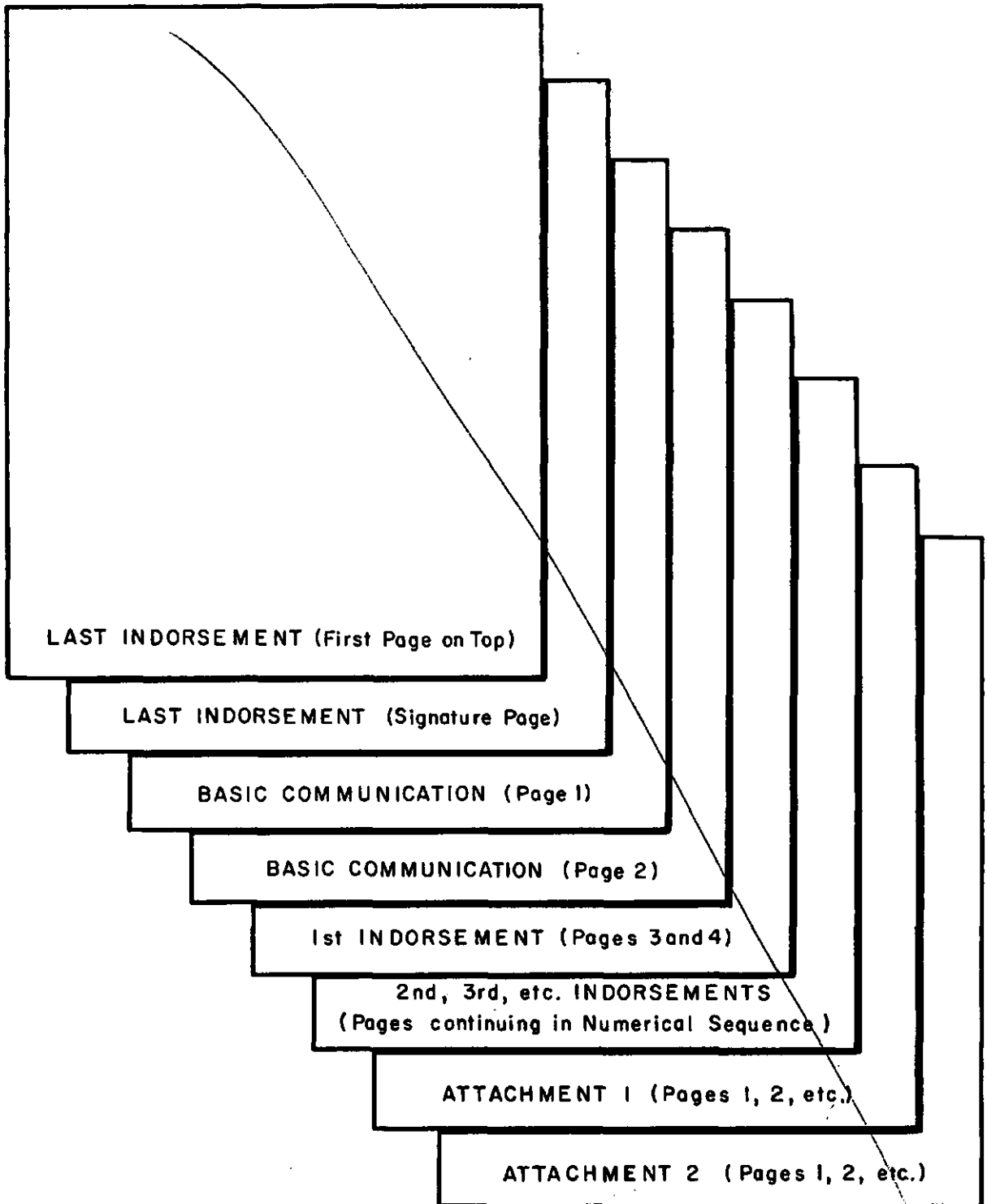

Figure 12. How To Assemble Basic Letter With Attachments, Indorsements, and Related Material for Filing (Par. 22)

(a) Arrange pages of latest indorsement in numerical sequence (on top of basic letter).

(b) Arrange pages of basic letter and all other indorsements in numerical sequence.

c. *Filing Date.* File correspondence arranged as prescribed in a and b above, *by date of latest action.*

23. Connecting Related Papers

When papers to be filed refer to or are concerned with previous documents relating to the same transaction, the previous documents will be brought forward and combined with the papers to be filed, if reference requirements justify such action. (See figure 12.) A cross-reference sheet will be substituted for papers brought forward from one folder to another in the same manner as provided in paragraph 17c, to maintain continuity.

★24. Fastening Practices

Papers relating to the same action, such as the basic letter with indorsements and attachments, will be stapled together in the upper left corner. The stapled documents will then be filed loosely in each folder. Documents in a subject file will not be fastened with prong fasteners. Prong

fasteners may be used for fastening documents that make up a "case" file. For such cases, a short strip of masking tape, pressure sensitive adhesive tape, or other suitable material should be applied on top of the metal fastener and affixed to the outside of the file folder. (See figure 12a.) This technique prevents tearing of folders in the file drawers and materially prolongs the life of the folder. It also insures that the fastener, when open, will not become detached from the folder. Documents to be added to a case file will be merely dropped in the case folder until the case is withdrawn for reference. All accumulated documents can then be punched and fastened at one time.

★25. Preparation and Use of Guides and Folders

Sample file arrangements illustrating the use of guides and folders in a correspondence file are shown in figures 13 and 14. Suggested arrangements of guides and folders for other than subject files are illustrated in chapter 2. Disposition Guide Cards used to identify separate series of records and which tell how the records that make up the series are disposed of are discussed in paragraph 19d. Alphabetical subdivisions listed in appendix B may be utilized for alpha-

*Prohibit use of letter
for subject file and
for subject file
of prep. series*

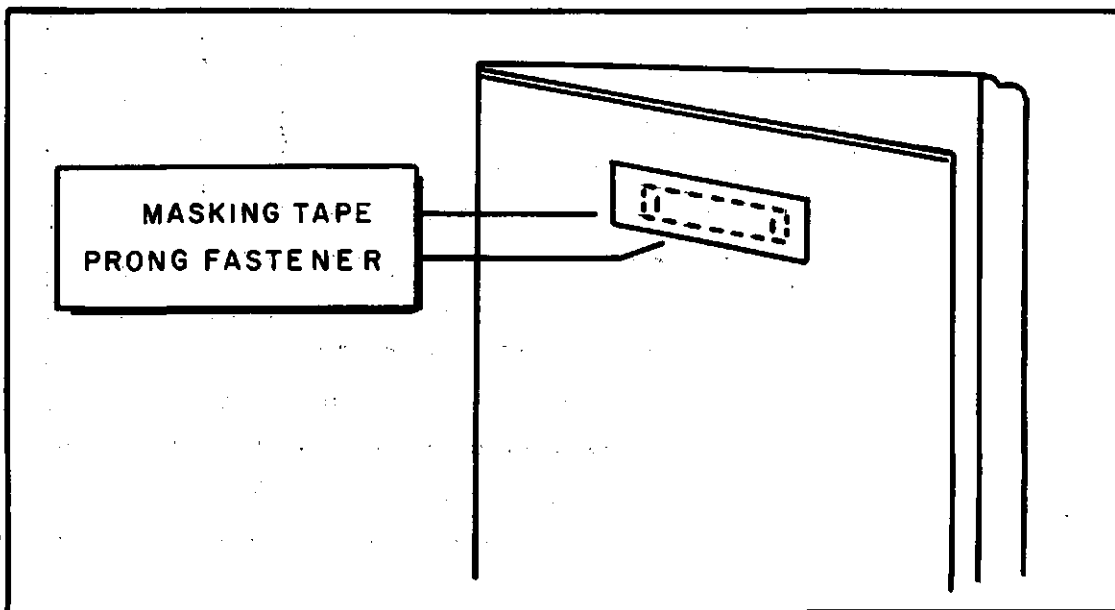

Figure 12a. Use of Masking Tape on Prong Fasteners

betical file guides. The standard guides, folders, and the labels prescribed for Air Force use are listed in chapter 5. Specific instructions for the use of guides and folders in the general correspondence file are prescribed below:

a. Guides:

(1) File guides serve as signposts to lead the searcher to specific portions of the file. They also support the folders.

(a) A first position guide will be prepared to introduce each major subjective category used in establishing a set of files.

(b) Guides in the second position are generally used for the primary subdivisions and in the third position for further subdivision. This guiding procedure and the use of first, second, and third guiding positions are illustrated in figure 13. However, to achieve a better balance of guides to folders, in instances where the tertiary and further subdivisions are numerous, it may be desirable to place both the major and primary categories in the first position, the secondary in the second position, and further subdivisions in the third position. This method of using guides is illustrated in figure 14.

(c) The rules for the use of guides are made flexible intentionally so that the user of the file may "guide" the file to make the best possible reference, considering the complexity of the file. As a general rule, in addition to the guide used to introduce each major subjective category, a guide will precede the first folder of each group of subjective subdivisions, as illustrated by figure 14.

(2) The major subjective code and title, i.e., MGT—ADMINISTRATIVE MANAGEMENT, is to be typed or printed on a standard label. Attach this label to the guide tab. For subdivisions, type the major subjective code and the title of the subdivisions; i.e., MGT 1—DOCUMENTATION AND RECORDS MANAGEMENT.

(3) Place guides in the file drawer from front to back in the alphabetical sequence of the major subjective codes; i.e., CIV, COM, FIN, etc. Arrange subdivision guides in numerical sequence under each category from front to back. Remove those guides in good condition before disposing of the file, and re-use them.

b. Folders:

(1) Use file folders to group related records together. Identify the folders by file symbol, complete subject title, and year; e.g., MGT 1—DOCUMENTATION AND RECORDS MANAGEMENT, 1961, on a standard label. Code words, project numbers, and other information may be added to further identify the file. The position of the label on the folder will correspond to the position of the related guide. Typing the information on the label is preferred.

(2) Place folders behind related guides. File papers within the folder so that the latest date will always be at the front. Do not overload folders. When the volume of records reaches about 3/4 inches, subdivide by placing a folder, labeled identically, in front of the existing folder. Add inclusive dates of the documents on each

Chg to. Make cert. of. not mandatory. Director's guide permanent.

add → (d) Guide as 2 (a), as to use 1 (a) & b, v 2 9 50/1.

*provide that item no., subj, & yr., be on std label affixed to folder, e.g.
3. MGT
2. Budgeting } = "3 2 Budgeting 1965"*

for copies of files: 1 Jan - 30 Jun 1965.
 for case files, enter opening date + leave closing date blank until case file is closed.
 5 Jan 1961 - (active); 5 Jan 1961 - 15 Jul 1965 (closed).

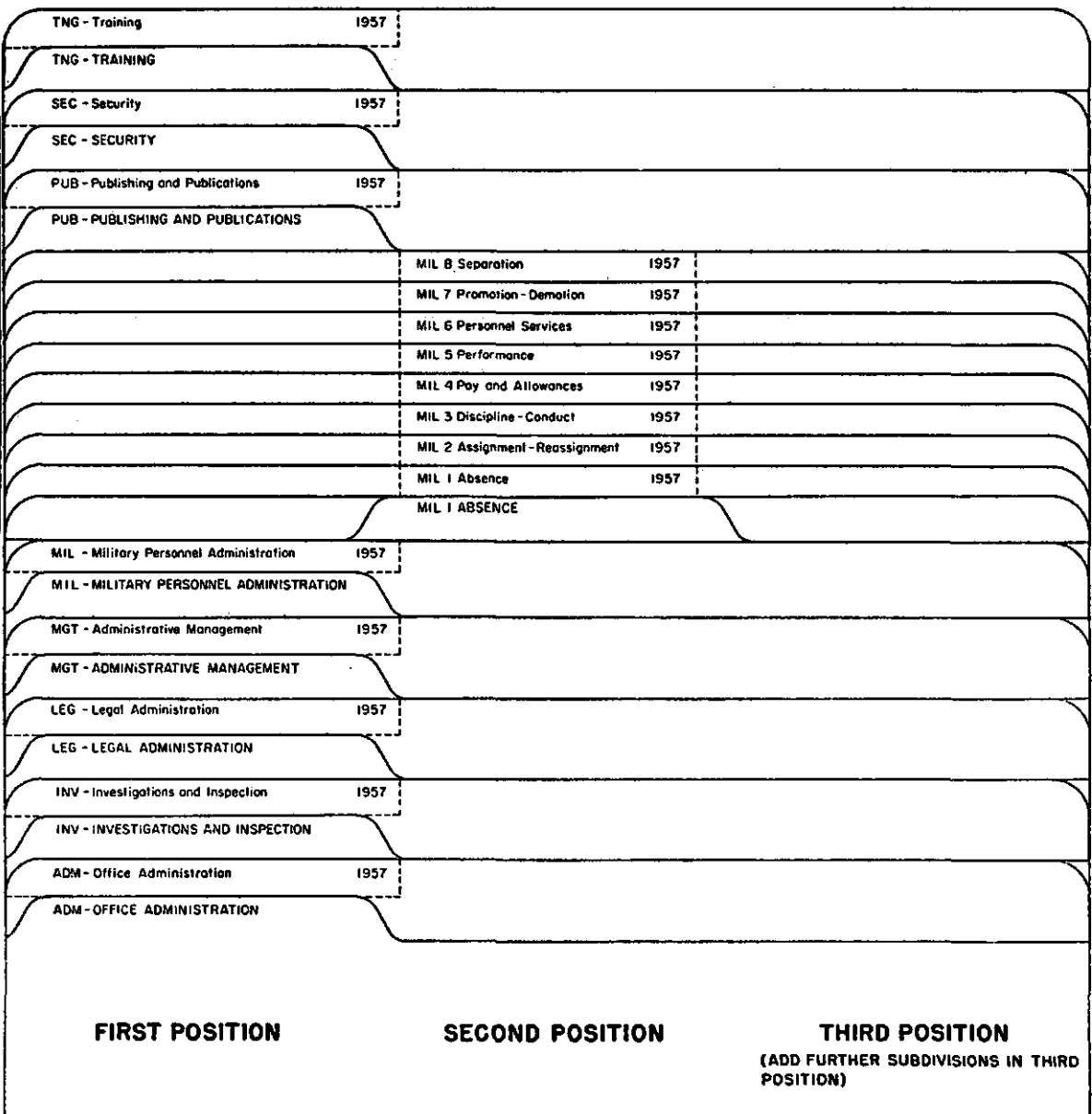

Figure 13. Subject File Arrangement showing Guides and Folders with only major Subjective Categories in the First Position (Par 25)

folder; e.g., 1 Jan - 30 Jun - 1958. These additional folders should contain documents of equal periods of one month, two months, and so forth, if practical. (See also par 15d(3).)

c. Positions of Guides and Folders. Positions of guides and folders should be consistent throughout the file. Figures 13 and 14 illustrate consistent arrangement of

guides and folders for major subjective categories, and further subdivisions.

26. Labeling Cabinets

Label each unclassified file drawer to identify the contents adequately. ~~Label cabinets containing classified material in accordance with AFR 205-1, and the implementing security directives applicable to the activity before labeling cabinets containing classified material.~~

(?) Chglang. to "open" in a manner which best suits the need of using eye?

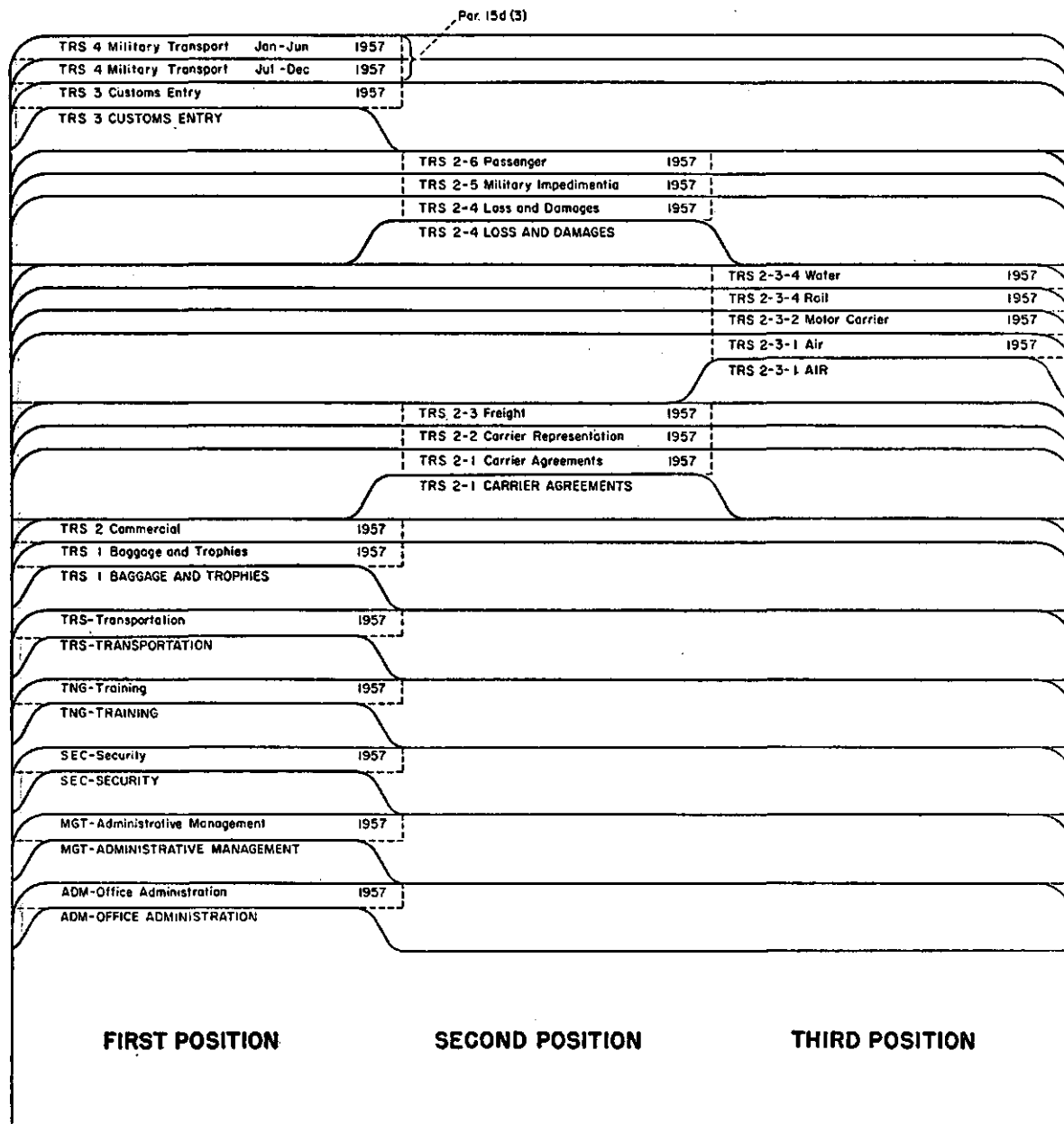

Figure 14. Subject File Arrangement showing Guides and Folders with major Subjective Categories and Primary Subdivisions in the First Position (Par 25)

27. Sorting

Sorting is the procedure for arranging records in proper sequence to facilitate filing. It also provides ready reference to the records in the event they are needed prior to actual filing in the appropriate folders. The extent to which records need be sorted depends upon the volume and filing arrangement. *See para - for sorting equipment*

a. Methods:

(1) Subjective files should be sorted and arranged first by major subjective categories. Then sort each major category into primary and secondary subdivisions as required.

(2) If the volume is small, alphabetical files may be sorted by arranging the papers to the first letter of the surname only. In

larger collections, it may be necessary to sort papers to the first several letters under which the papers are to be filed. When this is necessary, the alphabetical subdivisions contained in ~~Appendix B~~ ^{Appendix A} can be used as a guide or basis for labeling the sorting equipment.

(8) If the volume is small, numerical files may be sorted by the basic numbers 0 thru 9, e.g., in groups 1-999, 1000, 2000, etc. If the volume is large, sort each group into hundreds, then each hundred group into tens, etc. Numerical labels on sorting equipment from 0 through 9 can be used to represent tens, hundreds, thousands, etc. For example, 9 may also represent 90, 900, 9000, etc. Sort documents to be filed by terminal digit into groups from 00 to 99, to make 100 groups. If filing is to be by the primary group only, arrange the subsequent digits of the whole number in conventional numerical sequence within each primary group. However, if further sorting is required, sort each primary group by the first digit of the secondary group and each resulting group by the second digit of

the secondary group. Subsequent digits are filed in conventional numerical order within each group.

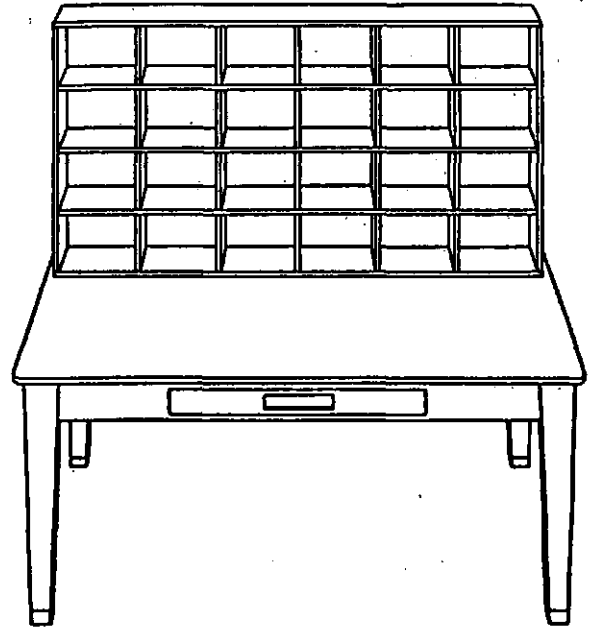

Figure 16. Rack Sorter (Par 27)

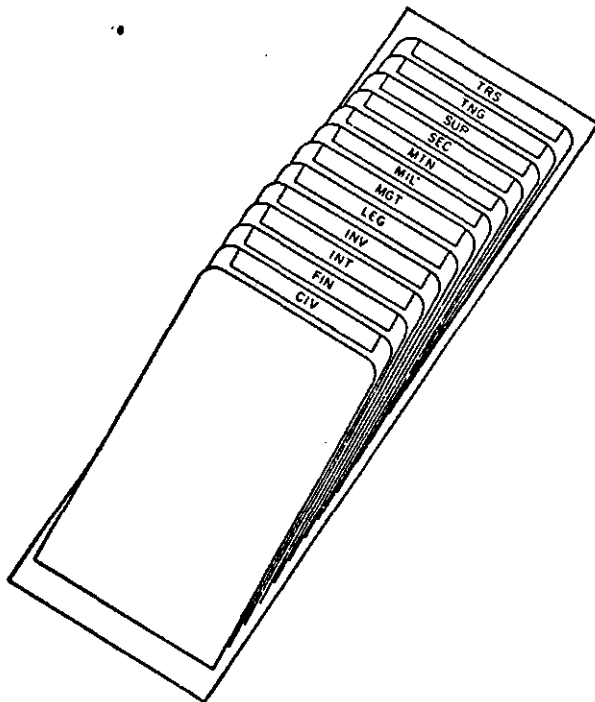

Figure 15. Correspondence Sorter (Par 27)

b. Equipment:

(1) A table or desk top may be used for sorting, when the volume of papers is small. This method is not recommended when the individual has frequent interruptions, as the papers may easily become disarranged.

(2) A correspondence sorter, illustrated in figure 15, is recommended for most ~~sorting~~ ^{sorting} operations. It has a series of dividers, three to four inches wide, each hinged to a flat base. Tabs can be labeled and inserted as required. A 24-division sorter will generally meet the sorting requirements of a small office of record; however, sorters with more divisions are available. Some are equipped with a sliding base mechanism.

(3) Other sorting equipment is available containing horizontal or vertical dividers. Rack sorters illustrated in figure 16 can be constructed to meet most sorting requirements.

also refer to AFM 181-4A that shows guidelines for filing

★28. Use of Charge-Out Forms

AF Form 614 and 614a, Charge Out Record, will be prepared and placed in the files as a substitute for papers or 5" x 8" cards borrowed for use by personnel both outside and within the immediate office of record. The preparation of the forms is self-explanatory. They will be filed **vertically** so that the top ^{OUT} portion of the form is visible. This will facilitate the identification of charged out records and expedite the refiling of them. The consistent use of these forms will eliminate much wasted effort in searching for documents while they are out of file.

29. Files Cut-off Procedures

a. *Purpose.* Files cut-off procedures are designed to control records accumulations, to prevent their growth into cumbersome and unmanageable collections, and to facilitate economical destruction or retirement of records in convenient blocks.

b. *General Policy.* Except as indicated below, all Air Force activities will establish their current records on a calendar year basis, cutting off each series of records on 31 December of each year and establishing

a new file for each series of records the next day.

(1) Records that must be maintained on a fiscal year basis will be cut off on 30 June of each year and a new file established on 1 July of the same year. For example, Fiscal Year 1958 records date from 1 July 1957 to 30 June 1958.

(2) When the retention period for records is ~~less than~~ one (1) year, they may be maintained on a daily, weekly, or monthly basis, if the amount accumulated warrants their disposal after periods of less than one (1) year. For example, records which are disposable after 6 months, could be cut off at the end of each month if the volume warrants it, a new file started the next day, and the cut off files disposed of when their retention period expires.

★(3) Case files are excepted from the annual cut off policy. They are cut off after the occurrence of a certain event, such as separation of personnel, final payment of a contract, or completion of a project. Withdraw completed or closed case files from the active file and place them in an inactive file maintained on an annual basis, or in accordance with specific instructions contained in AFM 181-5 for certain series of records.

Permit recording of Perm. w/ dev volume (any number stamp, when skinned) (any warrants) or hand skinned AF 614 w/ pertinent data

Revert to
provide controls
(Par 3 3 & 34) on
supplies above

Chapter 5

FILING SUPPLIES AND EQUIPMENT

30. Objectives. A continuing objective of the records management program is to provide for the proper, complete, and economical use of filing supplies and equipment. The use of standard supplies and equipment, application of the utilization standard, prescribed in paragraph 33, adequate control over requests for equipment, and periodic inspection of equipment in use, will insure economies in the use of filing supplies and equipment.

31. Standard Filing Cabinets. The following letter and legal size cabinets are standard equipment for maintaining letter and legal size documents, unless otherwise authorized by Table of Allowances 006. Existing stocks of 4-drawer cabinets will be used until the supply is exhausted.

a. *Letter Size.* 5 drawer, 1 drawer wide, 57½ inches high, 15 inches wide, 28 inches deep.

b. *Legal Size.* 5 drawer, 1 drawer wide, 57½ inches high, 18 inches wide, 28 inches deep. *Use only when ... (see 33).*

32. Standard Filing Supplies. The following are standard filing supplies for letter and legal size documents. The Kraft folders will meet the majority of filing requirements, since most records are current for a relatively short time before they are retired or destroyed. Pressboard folders are authorized only for case and project files, and then only when the Kraft folder will not withstand the added volume and/or use. They will not be used in maintaining correspondence files. Existing quantities of simi-

lar supplies will be used until the supply is exhausted.

a. *Folders:*

(1) *Kraft* (see figure 17):

(a) *Letter Size.* Square cut, reinforced top, 11 point, scored for ¾ inch expansion.

(b) *Legal Size.* Square cut, reinforced top, 11 point, scored for ¾ inch expansion.

(2) *Pressboard:*

(a) *Letter Size.* Square cut, self tab, 1 inch expansion.

(b) *Legal Size.* Square cut, self tab, 1 inch expansion.

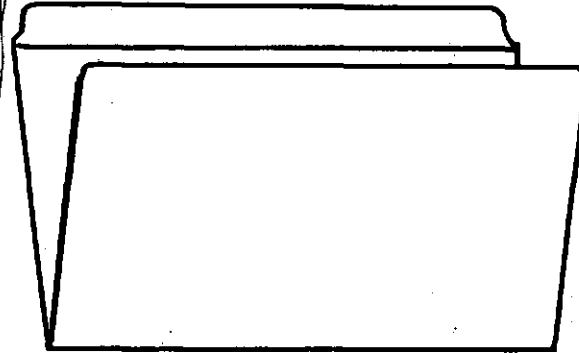

Figure 17. Square Cut, Reinforced Top Folder (Par 32)

b. *Guides* (see figure 18):

(1) *Letter Size.* One-third cut, self tab, pressboard, gray, 25 point, without lower projection.

(2) *Legal Size.* One-third cut, self tab, pressboard, gray, 25 point, without lower projection.

c. *Labels.* Gummed one side, blank, in fanfold strips, 3¾" x 11/8".

d. *Forms:*

- (1) DD Form 334, "Cross Reference Sheet."
- (2) AF Form 614, "Charge Out Record."
- (3) AF Form 80, "Files Maintenance and Disposition Plan."
- (4) AF Form 82, "Files Disposition Control Label."

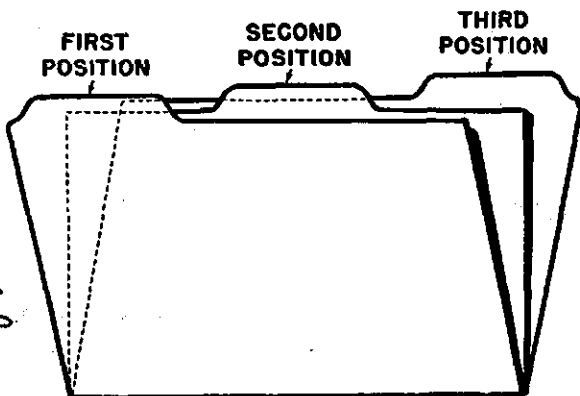

Figure 18. One-Third Cut, Self-Tab Pressboard Guide (Par 32)

quantities of legal size documents will be folded to fit letter-size cabinets.

c. Classified files must be maintained in filing equipment that meets the requirements of AFR 205-1. A portion of secure filing equipment not needed for classified files may be used for unclassified documents, provided such usage does not result in procuring additional secure equipment.

★33.1 **Nonstandard Equipment.** The criteria in a and b below are established for the requisitioning of nonstandard filing equipment. Procedures for the control and proper utilization of filing equipment are prescribed in paragraph 34.

a. *Specialized Filing Equipment.* This equipment is authorized to store records of unique size or to meet unique usage requirements when economies can be effected thereby except as indicated in b below.

b. *Powered and Other Mechanized Filing Equipment.* Procurement of powered or other mechanized filing equipment is prohibited unless the justification accompanying the requisition contains specific evidence that it meets one or more of the following criteria and the total savings to be realized exceeds the difference between the cost of standard and mechanized filing equipment when prorated over a 3-year period.

(1) *Manpower Savings.* That one or more positions (either existing or budgeted for) will be eliminated.

(2) *Space Savings.* That space saved through the use of the equipment will be used for other essential operating functions.

(3) *Work Production.* That any predicted increase in workload capability is based upon provable and current workload data.

34. **Procedures for Control of Filing Equipment.** The procedures prescribed below are considered the minimum necessary to effect adequate control and proper utilization of filing equipment. Implementing procedures that will improve equipment controls are

★33. **Utilization Standards for Filing Equipment.** Filing equipment includes all types of equipment designed to hold records. Filing equipment will be utilized in accordance with T/A-006, and the following criteria:

a. Records maintained in filing equipment will be limited to *current* records. The exception to this rule is that unused portions of steel filing cabinets and excess wooden file cabinets may be used for the storage of reference sets of publications, forms, and office supplies providing such usage does not require procurement of additional filing equipment. Such materials will otherwise be maintained in supply cabinets, bookcases, or on shelving, as appropriate. *Store classified materials in filing cabinets authorized for classified documents.*

b. Letter-size cabinets will be used for letter-sized documents. Legal size cabinets will be used *only* when at least one-fourth of the documents are of "legal" size. Small

Add only legal size cabinets for (Class 3)

14 May 1965

AFM 181-4D

encouraged. To effect control over filing equipment, the records officers and records management officers, as appropriate, will:

a. Review all requests for filing equipment prior to submission of the requests to the equipment review and authorization activity.

★b. Approve or disapprove each request based on a review of AF Form 80 and inspection of the records of the requesting office, to determine (1) whether present equipment is being utilized in accordance

cy 4a(1)-(6)

~~with standards prescribed in paragraph 33,~~ and (2) whether requests for powered, mechanized, or specialized filing equipment meets the criteria in paragraph 33.1.

★c. Periodically review the utilization of filing equipment to determine whether equipment is being used according to criteria prescribed in paragraphs 33 and 33.1. If equipment is not being properly utilized, recommend to the equipment review and authorization activity, redistribution or return of the equipment.

to supply channels, and a corresponding revision of authorized filing equipment in the Unit Authorization List.

35. Open Shelf Filing

The use of open shelf filing equipment may be more appropriate for filing current records than conventional filing cabinets, under certain conditions, as described in b, below.

a. *What Open Shelf Filing Is.* Open shelf filing is a method of filing records vertically on shelves instead of filing records in conventional filing cabinets. The equipment is metal, generally in three (3) foot sections of single or double face units, and adjustable to provide for 5 to 9 shelves high. Shelves are slotted to accommodate dividers for supporting guides and folders. Shelving is manufactured in any desired depth, but generally has base shelf 12-inches deep, with 9-inch, adjustable shelves above for filing letter size documents; or a base shelf 15-inches deep, with 12-inch, adjustable shelves above for legal size files.

b. *When It Should Be Used.* Open shelf filing equipment is most adaptable to current records that are case-filed under an

alphabetical or numerical arrangement, when these records total, or are expected to total 200 feet or more, and when the following conditions exist:

- (1) The filing installation is in a relatively permanent location.
- (2) The purchase of new filing equipment is contemplated.
- (3) Additional space for filing operations is required and only a limited amount of space is available.
- (4) The area is relatively free from excessive dust, and is not subject to infestation by rodents, and vermin.

(When these conditions prevail and shelf files are needed, doors are available as optional equipment.)

c. *General Comparisons with Filing Cabinets.* Open shelf filing equipment costs less than conventional filing cabinets, requires less office space, and permits ease of filing operations under the conditions specified in b, above.

d. *Guide for Comparison.* The table below shows comparisons between open shelf filing and conventional filing to serve as a guide in determining whether open shelf filing is adaptable to various filing operations.

Factor	Open Shelf Equipment	5-Drawer Cabinets
1. Equipment (for 200 linear feet of records):	2 single-faced sections 4 double-faced sections 7 shelves high	19
2. Cost (Approximate):	\$320. Accessory items such as finished end panels, label-holders, top dust plates, and pull-out shelves must be obtained at extra cost.	\$1155
3. Space (less aisle space):	30 square feet	68.5 square feet
4. Aisle Space required:	30-inch minimum	36-inch minimum
5. Mobility	Shelving may require dismantling and reassembly. Records will have to be packed and refiled.	Can be moved intact.
6. Adaptability to Methods of Filing:	Best suited for case files arranged by name or number.	All types of letter and legal size files.

See TAB AG 1 on any filing

Factor	Open Shelf Equipment	5-Drawer Cabinets
7. Filing Operations: a. Removing and replacing folders: b. Inserting and removing papers fastened to folders: c. Inserting and removing papers filed loosely in folders: d. Folder searching: e. Indexing and charge out: f. Height: g. Distance: h. Classified records:	20 to 35% faster. 10 to 20% faster. Slower, because folders must be withdrawn from shelves to insert or remove papers. 20 to 35% faster. Same as used for records stored in in cabinets. Records stored in top and bottom shelves results in reaching and stooping for records. Top and bottom shelves should be used for inactive records. Compactness of records results in less distance to files, reducing unproductive walking time. In secure storage area, eliminates opening, closing, locking, and checking file cabinets.	Faster, for opposite reasons. Requires bending for bottom drawers. Bottom drawers used for relatively inactive records. Cabinets are spread over larger area.
8. Filing Accessories: a. Guides: b. Folders: c. Dividers:	Special hook-type, pressboard guides with side tabs readable from either side. Cost is approximately \$21 per hundred. Standard square cut kraft folders may be used. For easier visibility, folders in upper shelves may be marked at the bottom front flap. Metal dividers supplied with equipment are required to support folders and guides.	Standard file guides cost about \$4 per hundred. Same. Compressors or metal dividers are used.
9. Appearance: a. Neatness: b. Dust problem:	Untidiness of records is noticeable. Dust is not considered a problem if records are fairly active.	Records are hidden. Dust is no problem.
10. Hazards: a. Fire: b. Water Sprinkler Systems:	Normal fire precautions should suffice. Metal covers over top shelf minimize water damage.	Better protection. Better protection.

Delete & include down in #15 f.

Appendix A

AIR FORCE SUBJECTIVE CLASSIFICATION SYSTEM

1. This Appendix contains:

- a. A brief resume of the key points to be remembered in applying the Air Force Subjective Classification System;
- b. A brief description of the scope of each major subjective category;
- c. The "Master Outline" which lists the major subjective categories and their subdivisions; and
- d. The "Relative Index" to the Master Outline.

2. In setting up the files and in applying the filing system, as provided in Chapter 3, keep the following instructions in mind:

- a. Become familiar with the functions and operations of the offices using the records, so that the records will be classified and arranged to properly document their functions and operations.

- b. Prepare a file outline, as prescribed in paragraph 15g, using only the major subjective categories, and a minimum of subdivisions under each, as required.

- c. Classify subject matter on the basis of pertinence, interest, or significance to the primary functions and responsibilities of the offices for which the records are maintained. Be sure to classify documents that fall in "Office Administration" properly, as described in paragraph 3a of this Appendix.

3. A brief description of the "scope" of each major subjective category is provided below. When considered necessary, examples of the application of the system are also provided. The subdivisions of the major subjective categories are in themselves a definition of the major subject and its scope.

a. ADM—OFFICE ADMINISTRATION. This file category is established for the pur-

pose of classifying and grouping all documents that are accumulated in carrying out the *internal* administration or "housekeeping" activities of the office, as distinguished from those documents that are incident to the primary mission. For example; this category will consist of:

- a. The local budget of the immediate office;
- b. Correspondence pertaining to the administration of personnel assigned to the office;
- c. Records pertaining to charity campaigns;
- d. Requests for office services, supplies, and equipment;
- e. Local mail handling and control;
- f. Local security operating procedures;
- g. Those subjects which are inherently "office services" in nature, such as space control, graphic presentation, etc.

Thus, this category serves as a convenient means for segregating all non-mission correspondence and related papers which can be destroyed after two (2) years for all levels of the organization, under the provisions of AFM 181-5.

b. CIV—CIVILIAN PERSONNEL ADMINISTRATION. This file category includes subjects relating to the functions affecting civilian personnel including classification, pay administration; recruitment, employment, placement, and separation of civilian employees; employee-management relations and necessary employee services; career development of civilian employees; participation in the programs of the Boards of US Civil Service Examiners; and promotion and administration of the Air Force

employee incentive programs. All subjects pertaining to civilian pay operations are correlated under FINANCIAL MANAGEMENT. Travel by civilians incident to official business, fundamentally a "Transportation" subject is correlated under CIV since it is administered by Civilian Personnel Officers.

c. COM—COMMUNICATIONS. The subjects in this category relate to the establishment, maintenance and operation of facilities for the electrical transmission of communications.

d. FIN—FINANCIAL ^{ADMINISTRATION} MANAGEMENT. This category includes subjects relating to the disbursement, collection, and accounting for public funds; the operation of the appropriation, expenses, cost, monetary property, and international accounting systems; auditing for Air Force and industrial accounts; budgeting; civilian payroll operations (for military payroll, see MIL 8); and subjects relating to nonappropriated funds, surety bonds and reports of survey.

e. INS—INSTALLATION MANAGEMENT. This category relates to the construction, maintenance, and operation of facilities including land, buildings, other fixed structures and their appurtenances; family housing; and the related engineering planning programs.

f. INT—INTELLIGENCE. The subjects in this category concern the collection, analysis, exploitation, and dissemination of intelligence information of military value.

g. INV—INVESTIGATIONS AND INSPECTIONS. This category primarily concerns formal inspections, and investigations performed by representatives of the Inspector General's office. The reports of such inspections and investigations are usually maintained as a separate series of records and are filed by numbered unit or by the nature or object of inspection. Reports of activities performing informal inspections and staff visits should classify them according to the subject of the report.

h. LEG—LEGAL ADMINISTRATION. This category includes subjects relating to administration of military justice, process-

ing claims, legal assistance for military personnel and dependents; legal opinions and interpretations; patents; and taxation. The subdivisions under LEG-4 are taken from "the Digest of Opinions—the Judge Advocates General of the Armed Forces" and are intended for use by legal offices as required. Documents involving the rendering of an opinion, if accumulated by other than legal offices, should be classified according to the subject matter of the opinion.

i. MAP—MAPPING AND CHARTING. This category relates to the development, compilation, production, and distribution of aeronautical maps and charts. The subject of aerial mapping and charting photography is correlated under the major subjective category "PHO—PHOTOGRAPHY," as it is fundamentally a photographic technique.

j. MED—MEDICINE AND DENTISTRY. This category includes subjects concerning the veterinary services, aeromedical evacuation; general medical and health status of Air Force personnel; hospital and dispensary administration; and professional services and clinics.

k. MGT — ADMINISTRATIVE MANAGEMENT. This category is used to group functions, techniques and activities relating to the general field of management; as distinguished from specific management functions. Specific management functions are covered by other major subjective categories. Some of these subjects are: documentation and records management; management planning and improvement; histories; ground safety; postal operations; reports management; and organization of Air Force units.

l. MIL—MILITARY PERSONNEL ADMINISTRATION. This category relates to the administration of military personnel; their pay, welfare, recreation, and morale. It also includes chaplain functions. Subjects dealing with the training of military personnel are found under the major subjective category of "Training." Correspondence and other documents pertaining to the service career of an individual should be filed in the individual's Field Personnel Records Group or the Command Personnel Records

Group, as appropriate, rather than in a subject file.

m. MTN—MATERIEL MAINTENANCE ENGINEERING. This category involves preventive maintenance; servicing; repair; modification; and related subjects involving the maintenance of materiel.

n. OPS—OPERATIONS. This category refers to military air operations which involve the preparation for, and conduct of, air warfare. Flight operations during peace and war are included. Peacetime operations also include subjects relating to maneuvers, flights, exercises, war games, and related activities. Be sure to distinguish between the type of operations above, and the subject matter of other unrelated activities which are designated as "operations" in a general sense. Such subjects should be classified under the appropriate major subjective category.

o. PHO—PHOTOGRAPHY. This category includes subjects relating to aerial mapping and charting, motion picture and still photography, sound recordings and related photographic activities.

p. POL—POLICE OPERATIONS. This category relates to the enforcement of law and order; the confinement, retraining and restoration of prisoners; and related activities of provost marshals; except "military security," which is established as a separate major subjective category.

q. PRO—PROCUREMENT. This category covers the procurement of materiel and services from sources outside the Air Force by contract, purchase, and other negotiations. It includes such related matters as industrial resources, production planning, and quality control.

r. PUB—PUBLISHING AND PUBLICATIONS. This category covers subjects concerning the preparation, printing, and distribution of publications and forms. Record and reference sets of publications

are not to be filed in this category. They are filed as separate series of records.

s. R&D—RESEARCH AND DEVELOPMENT. This category includes subjects representing areas and objectives of research and development. The subdivisions of this category are grouped to meet research and development requirements and are based on technical groupings.

t. REL—RELATIONS AND LIAISON. This category includes subjects involved in the internal and public information program. It also includes subjects relating to external relations, such as international affairs and legislative relations.

u. SEC—SECURITY. This category is intended to cover the responsibilities and activities of maintaining the National security, and particularly the safeguarding of classified information.

v. SUP—SUPPLY AND SERVICES. This category involves subjects dealing with the storage, distribution, handling, and cataloging supplies; and furnishing laundry, commissary, and other services.

w. TNG—TRAINING. This category concerns the training of military and civilian personnel. Subjects concerning the training of civilians as part of the career development program may be subdivided under CIV 2—CAREER DEVELOPMENT. It includes subjects involved in the various types of training that are conducted, as well as those concerning the Air Academy, reserve activities, foreign trainees, and colleges and universities.

x. TRS—TRANSPORTATION. This category concerns the movement of cargo and passengers by commercial and military land, air, and water transportation.

y. WEA—WEATHER. This category includes subjects concerning weather forecasting, observation, and related meteorological activities and services.

MAJOR SUBJECTIVE CATEGORIES AND SYMBOLS

Symbol	Category
ADM	OFFICE ADMINISTRATION
CIV	CIVILIAN PERSONNEL ADMINISTRATION
COM	COMMUNICATIONS
FIN	FINANCIAL MANAGEMENT ADMINISTRATION
INS	INSTALLATIONS MANAGEMENT
INT	INTELLIGENCE
INV	INVESTIGATIONS AND INSPECTION
LEG	LEGAL ADMINISTRATION
MAP	MAPPING AND CHARTING
MED	MEDICINE AND DENTISTRY
MGT	ADMINISTRATIVE MANAGEMENT
MIL	MILITARY PERSONNEL ADMINISTRATION
MTN	MATERIEL MAINTENANCE ENGINEERING
OPS	OPERATIONS
PHO	PHOTOGRAPHY
POL	POLICE OPERATIONS
PRO	PROCUREMENT
PUB	PUBLISHING AND PUBLICATIONS
R&D	RESEARCH AND DEVELOPMENT
REL	RELATIONS AND LIAISON
SEC	SECURITY
SUP	SUPPLY AND SERVICES
TNG	TRAINING
TRS	TRANSPORTATION
WEA	WEATHER

Office Administration—ADM

1	Administration of Office Personnel
2	Budgeting
3	Charity and Public Interest Campaigns
4	Graphic Presentation
5	Mail and Messenger Services (Local)
6	Office Supplies and Equipment
7	Security Procedures for Local Office
8	Space Control
8-1	Conference Rooms
8-2	Moving

7-1	Employee Groups
7-2	Fair Employment Practices
7-3	Grievances
7-4	Housing—Transportation—Food Services
7-5	Insurance
	Government Life
	Hospitalization
7-6	Recreation, Morale, and Welfare
8	Employment Records
8-1	Official Personnel Folder
9	Hours of Work
9-1	Tours of Duty
10	Leave
10-1	Annual
10-2	Sick
10-3	Without Pay (LWOP)
11	Pay Administration (Payroll Operations—See FIN 11)
11-1	Employee Claims
11-2	Indebtedness
11-3	Overtime
11-4	Pay Rate Determination
12	Performance
12-1	Awards—Commendations
12-2	Incentive Programs (Suggestions)

Civilian Personnel Administration—CIV

1	Accessions
2	Career Development
3	Compensation for Injury or Death
4	Conduct
4-1	Disciplinary Actions
4-2	Gratuities and Favors
4-3	Political Activity
5	Death and Burial
6	Detailing Employees
7	Employee Relations

12-3 Ratings
 Appeals
 12-4 Standards
 13 Position Classification
 13-1 Position Series and Standards
 13-2 Surveys
 14 Promotion and Demotion
 15 Recruitment and Placement
 15-1 Applications
 15-2 Boards of Civil Examiners
 15-3 Oversea Employment
 15-4 Qualifications (Training, Experience, and Physical) Examinations (Mental and Physical)
 15-5 Selection
 16 Restoration after Military Service
 17 Separation
 18 Travel
 18-1 Passports—Visas
 18-2 Per Diem

Communications—COM

1 Communications Center Operations
 1-1 Communications Accounts
 1-2 Message Transmission (Distribution and Control)
 1-3 Relay Centers
 2 Communications Security
 2-1 Cryptosecurity Accounts
 2-2 Physical Security (of communications facilities and cryptomateriel) (see also SEC 2)
 2-3 Transmission Security
 3 Communications Systems
 3-1 Airborne Communications
 3-2 Amateur Radio (MARS)
 4 Fixed Radio and Wire Facilities
 4-1 Commercial Facilities
 4-2 Control Stations
 4-3 Flight Checks
 4-4 Frequency Authorizations
 4-5 Plant in Place
 Maintenance

Financial Management—FIN

1 Appropriation Accounting
 1-1 Advance Payments and Recoupments
 1-2 Allocation, Sub-Allocation and Allotment of Funds
 Administrative Control
 Advice of
 Records
 Adjustments and Corrections
 Allocation, Sub-Allocation Ledgers
 Allotment Ledgers
 Subsidiary Allotment Ledgers

1-3 Annual Budget Authorization
 1-4 Claims
 1-5 Collections
 Appropriation Receipts
 Appropriation Refunds
 Appropriation Reimbursements
 General Fund Miscellaneous Receipts
 Deposit Fund Accounts
 Records
 Control Ledgers
 Subsidiary Collection Ledgers
 Reporting Instructions and Requirements
 1-6 Commitments
 1-7 Disbursements, Expenditures
 1-8 Inter-Intradepartmental Transactions
 1-9 Obligations
 1-10 Special Activities and Tenants
 2 Auditing
 2-1 Administration and Control
 2-2 Auditor's Records
 2-3 Contract Audits
 2-4 Intra-Air Force Audits
 3 Banking—Currency
 4 Budgeting
 4-1 Budget Program Management
 Annual Financial Plan
 Apportionments
 Appropriation Law
 Funds Administration
 Special
 Transfers
 4-2 Budget Structure
 AF Budget Code (Fiscal Code)
 4-3 Estimates
 Call for Estimates
 Program Guides and Assumptions
 Justification
 Review
 Special (Flash)
 Supplemental
 4-4 Federal Budget
 5 Cost Accounting
 5-1 Air Installations Maintenance
 5-2 Depot Maintenance
 5-3 Field Maintenance
 5-4 Motor Vehicles Maintenance
 6 Expense Accounting
 6-1 Accounting Procedures
 Chart of Accounts
 Contractual Services
 Materiel
 Medical Services
 Personnel Services
 Special Activities and Tenants
 Travel and Transportation
 6-2 Records
 Expense Ledger—Accounts
 Subsidiary Ledgers and Files

6-3	Reporting Instructions and Requirements
7	General Ledger Accounting
7-1	Accounting Procedures
	Chart of Accounts
	Special Activities and Tenants
7-2	Records
	General Ledger Control Accounts
	Subsidiary Ledgers and Files
7-3	Reporting Instructions and Requirements
8	International Accounting
8-1	Agreements, Bilateral
	Canada
	Korea
	South Africa
	United Kingdom
8-2	ANZUS
8-3	MAP (formerly MDAP)
8-4	NATO
8-5	SHAPE
9	Monetary Property Accounting
9-1	Equipment
9-2	Inventory Accounting, Monetary
9-3	Real Property
10	Nonappropriated Funds
10-1	Revenue Producing Activities and Funds
	Book Department Funds
	Exchange Service Funds
	Motion Picture Service Funds
	Post Restaurants Funds
	Vocational Training Activities Funds
10-2	Sundry Association Activities and Funds
	Central Mess Funds
	Chaplains Funds
	Installation and Organizational Religious Funds
	Officers', Non-Commissioned Officers', and Cadets' Open Messes
10-3	Welfare Activities and Funds
	Base Trust Funds
	Central Base Funds
	Central Welfare Funds
	Civilian Welfare Funds
	Command Welfare Funds
	Unit Funds
11	Payroll Operations (Civilian Pay) (Also See MIL 10)
12	Revolving Funds
12-1	Industrial Funds
	Laundry and Dry Cleaning Services
	Printing Services
12-2	Management Funds
12-3	Stock Funds
	Air Force Academy Division
	Aviation Fuels Division
	Clothing Division
	Monetary Allowance System
	Commissary Division
	General Supplies Division
	Medical-Dental Division
12-4	Working Capital Funds

13	Salvage and Surplus Materiel Accounting
14	Statement of Charges
15	Surety Bonds
16	Survey, Reports of

Installations Management—INS

1	Facilities (Construction, Maintenance and Operation)
1-1	Airfields, Pavements, Aprons, etc.
1-2	Building Equipment
1-3	Buildings and Structures (Subdivide by type as required)
1-4	Custodial Services
1-5	Fire Protection and Aircraft Crash Rescue
1-6	Grounds
1-7	Insects, Rodent and Vermin Control
1-8	Liquid Fuel Storage and Dispensing Systems
1-9	Railroads
1-10	Refuse Collection and Disposal
1-11	Roads and Other Surfaced Areas (Except Airfields, Pavements, etc.)
1-12	Training Aids
1-13	Utilities
	Air Conditioning Systems
	Electric Plants and Systems
	Gas Plants and Systems
	Heating Plants and Systems
	Sewage Plants and Systems
	Water Plants and Systems
2	Family Housing
2-1	FHA Housing
2-2	Title VIII Housing (Wherry Housing)
3	Planning Engineering
3-1	Construction Planning (Program and Projects)
3-2	Design Criteria
3-3	Master Planning (Programs)
4	Real Estate
4-1	Acquisition
4-2	Disposal
4-3	Utilization

Intelligence—INT

1	Collection—Dissemination
1-1	Attaches, Air
1-2	Briefing
1-3	Captured Materiel
1-4	Clandestine Source
1-5	Communications—Electronics
	Communications
	Collection—Dissemination
	Interception
	Electronics
	Collection—Dissemination
	Interception

- | | | | |
|------|--|-------|--|
| 4-12 | Charges and Specifications | 4-67 | New Trial |
| 4-13 | Citizenship and Naturalization | 4-68 | Non-Judicial Punishment |
| 4-14 | Civilian Officers and Employees | 4-69 | Oaths and Affirmation |
| 4-15 | Claims | 4-70 | Officers |
| 4-16 | Coast Guard | 4-71 | Patents and Copyrights |
| 4-17 | Coast Guard Academy | 4-72 | Pay and Allowances |
| 4-18 | Commissaries, Post Exchanges and Related Services | 4-73 | Perjury and False Swearing |
| 4-19 | Communications and Correspondence | 4-74 | Pleas and Motions |
| 4-20 | Conduct Improper Under Uniform Code of Military Justice | 4-75 | Posts, Bases, and Other Installations |
| 4-21 | Conspiracy | 4-76 | Prisoners |
| 4-22 | Contracts | 4-77 | Prisoners of War |
| 4-23 | Courts-Martial | 4-78 | Publications |
| 4-24 | Courts of Inquiry | 4-79 | Rape and Carnal Knowledge |
| 4-25 | Decorations, Medals, Badges, etc. | 4-80 | Records and Reports |
| 4-26 | Defenses | 4-81 | Rehearing |
| 4-27 | Depositions | 4-82 | Reserve Forces |
| 4-28 | Desertion | 4-83 | Retirement |
| 4-29 | Disobedience to Orders and Regulations | 4-84 | Review |
| 4-30 | Disrespect Toward Superior or Noncommissioned Officers | 4-85 | Riot |
| 4-31 | Drunk on Duty | 4-86 | Robbery |
| 4-32 | Enlisted Men | 4-87 | Schools and Education |
| 4-33 | Evidence | 4-88 | Search and Seizure |
| 4-34 | Extortion | 4-89 | Self-Incrimination |
| 4-35 | False Claims | 4-90 | Sentence and Punishment |
| 4-36 | False Official Statements | 4-91 | Sodomy |
| 4-37 | Finance | 4-92 | Soldiers' and Sailors' Civil Relief Acts |
| 4-38 | Forgery | 4-93 | Supplies, Service, and Equipment |
| 4-39 | Frauds Against The Government | 4-94 | Theaters and Motion Pictures |
| 4-40 | Fraudulent Enlistment, Appointment, and Separation | 4-95 | Transportation |
| 4-41 | Government Life Insurance | 4-96 | Treaties |
| 4-42 | Graves and Cemeteries | 4-97 | Trial |
| 4-43 | Homicide | 4-98 | Uniform |
| 4-44 | Hospitals, Medical and Dental Treatment | 4-99 | Unit, Welfare, and Similar Funds |
| 4-45 | Housebreaking | 4-100 | Vessels |
| 4-46 | Insignia | 4-101 | Veterans |
| 4-47 | International Law | 4-102 | War and Defense |
| 4-48 | Investigations | 4-103 | Warrant and Flight Officers |
| 4-49 | Lands and Buildings | 4-104 | Waste and Destruction of Property |
| 4-50 | Larceny and Wrongful Appropriation | 4-105 | Witness |
| 4-51 | Line of Duty | 4-106 | Worthless Checks |
| 4-52 | Loss, Damage, or Wrongful Disposition of Military Property | 5 | Patents |
| 4-53 | Maiming | 5-1 | Copyrights |
| 4-54 | Malingering | 6 | Taxation |
| 4-55 | Marine Corps | | |
| 4-56 | Military Academy | | |
| 4-57 | Military Personnel | | |
| 4-58 | Military Security | | |
| 4-59 | Misbehavior of Sentinel | | |
| 4-60 | Missing Movement | | |
| 4-61 | Motor Vehicles | | |
| 4-62 | Mutiny and Sedition | | |
| 4-63 | National Guard | | |
| 4-64 | Naval Academy | | |
| 4-65 | Naval Militia | | |
| 4-66 | Navy | | |

Mapping and Charting ~~MAP~~

- | | |
|-----|---------------------------------------|
| 1 | Aeronautical Information Publications |
| 1-1 | Aeronautical Overprints |
| 1-2 | Foreign Clearance Guides |
| 1-3 | Jet Flight Information Manuals |
| 1-4 | Pilot's Handbooks |
| 1-5 | Radio Facility Charts |
| 2 | Air Target Materials |
| 2-1 | Geodetic Data Sheets |
| 2-2 | Radar Return Codes |
| 2-3 | Reliability Data Sheets |
| 2-4 | Target Charts |
| 2-5 | Target Mosaics |
| 3 | Chart Quantities and Stocks |

- 4 Development
 - 4-1 Experimental Items
 - 4-2 Portrayal
 - 4-3 Test and Evaluation
- 5 Distribution
- 6 Exchange Agreements
- 7 Hydrographic Charts
- 8 Maps
- 9 Production
- 10 Requirements
- 11 Source Materials
 - 11-1 Evaluation of
 - 11-2 Dissemination
 - 11-3 Procurement
 - 11-4 Utilization
- 12 Special Charting Items
 - 12-1 Aeronautical Video Plate
 - 12-2 Special Charts
 - 12-3 Special Mosaics
 - 12-4 Terrain Models
- 13 Standard Series Aeronautical Charts
 - 13-1 Aeronautical Approach Charts
 - 13-2 Aeronautical Planning Charts
 - 13-3 Cloth Charts
 - 13-4 Crash Grid Charts
 - 13-5 Equidistant Charts
 - 13-6 Evasion Charts
 - 13-7 Navigation Charts
 - 13-8 Radar Tracking Charts
 - 13-9 Strategic Charts
 - 13-10 Weather Charts
 - 13-11 World Aeronautical Charts

Medicine and Dentistry—MED

- 1 Aeromedical Evacuation
 - 1-1 Forward Evacuation
 - 1-2 Inter-Theater Evacuation
 - 1-3 Intra-Theater Evacuation
- 2 Dentistry
 - 2-1 Dental Clinic Administration
 - 2-2 Dental Health Records (Forms, Content and Procedures)
 - 2-3 Dental X-Ray
 - 2-4 Preventive Dentistry
 - Oral Hygiene
 - Prophylaxis
 - 2-5 Prosthetics
 - Laboratory Activities
 - 2-6 Special Dental Materials
 - Accountability
 - 2-7 Treatment
 - Policies and Standards
- 3 General Medical and Health Status
 - 3-1 Air Crew Effectiveness
 - 3-2 Battle Casualties
 - 3-3 Diseases

(Further subdivision of this subject will correspond to the classification of DD Form 442, Morbidity Report)

- 3-4 Injuries
- 4 Hospital and Dispensary Administration
 - 4-1 Capacity and Status
 - 4-2 Clinical Records
 - 4-3 Patient Management
 - Admission and Disposition
 - Discharge
 - Leave
 - Transfers
- 5 Physical Examinations
- 6 Preventive Medicine
 - 6-1 Biological Defense
 - 6-2 Environmental Sanitation
 - 6-3 Immunization
- 7 Professional Services and Clinics
 - 7-1 Aviation Medicine
 - 7-2 Dietary
 - 7-3 Laboratory
 - 7-4 Medical
 - Cardiovascular
 - Dermatology
 - Gastroenterology
 - Internal Medicine
 - Pediatrics
 - Physical Medicine
 - Psychiatry and Neurology
 - 7-5 Nursing
 - 7-6 Pharmacy
 - 7-7 Roentgenology
 - 7-8 Surgical
- 8 Veterinary Service
 - 8-1 Base Veterinary Service
 - 8-2 Food Examination
 - Point-of-Origin Inspection

Administrative Management—MGT

- 1 Documentation Control and Records Management
 - 1-1 Communications (written)
 - Control
 - Preparation
 - Referral
 - 1-2 Disposition of Records
 - Disposal
 - Retirement (Packing and Shipping Procedures)
 - Records Centers
 - Staging Areas
 - Schedules (Preparation of)
 - Transfer
 - 1-3 Maintenance of Current Records
 - 1-4 Microfilming
- 2 Functions (Missions and Responsibilities)
 - 2-1 Air Doctrine
 - 2-2 Charts (Organization)
 - 2-3 Command Jurisdiction and Prerogatives
 - 2-4 Delegation and Designation of Authority
 - (See also PRO 8-2)

3	Ground Safety
3-1	Education and Training Safety Awards Safety Educational & Promotional Materials Training and Career Development Visual Aids
3-2	Engineering & Research Facilities Materiel and Equipment Safety Engineering & Research Planning
3-3	Motor Vehicle Transportation Government Vehicles (General Purpose) Government Vehicles (Special Purpose) Private Vehicles
3-4	Reports and Analysis Accident Analysis Studies Ground Accident Experience Data Standard Statistical Tabulation USAF Ground Accident Reports USAF Ground Accident Summaries
4	Historical Documentation and Properties
4-1	Historical Properties
4-2	Monographs
4-3	Unit Histories
5	Interservice Relations (Joint Activities)
6	Management Planning and Improvement (Surveys and Studies)
6-1	Office Methods and Procedures
6-2	Organizational Analysis
6-3	Program Planning and Analysis
6-4	Work Measurement—Production Layout and Materiel Flow Production Control and Scheduling Survey and Audit Work Measurement Work Simplification
7	Manpower
7-1	Tables of Distribution (Unit Manning Documents) Position Authorization (Spaces) Civilian Military
7-2	Tables of Organization and Equipment
7-3	Utilization
8	Organization (Including, generally, the organization of boards and committees. Classify documents pertaining to the organization and work of specific boards and committees by subject, using the name of the board or committee as the subdivision of subject, as required.)
8-1	Activation
8-2	Assignment of Organizational Units Unit Movements
8-3	Constitution

8-4	Designation Insignia—Flags Nomenclature
8-5	Disbandment
8-6	Discontinuance
8-7	Inactivation
8-8	Reorganization
9	Postal and Courier Service
9-1	Courier System Courier Transfer Stations (CTS)
9-2	Distribution
9-3	Money Orders
9-4	Penalty Matter
9-5	Post Offices (APO's)
9-6	Postage
9-7	Postal and Courier Equipment
10	Statistics and Reports Management
10-1	Machine Records Machine Procedures Punch Card Accounting Equipment
10-2	Reports Control System
10-3	Statistical Data Repository
	Forms Management
	Military Personnel Administration—MIL
1	Absence
1-1	AWOL
1-2	Desertion
1-3	Leave Emergency
2	Assignment and Reassignment
2-1	Air Force with the Armed Services of US and other Countries Armed Services with the Air Force
2-2	Attached
2-3	Flying Status
2-4	Permanent Change of Assignment
2-5	Permanent Change of Station
2-6	Release
2-7	Temporary Duty
2-8	Career Development
3	Classification
3-1	Qualification Records (Such as AF Form 11, etc.)
3-2	Chaplaincy
4	Cultural Activities
4-1	Ecclesiastical Indorsing Agencies
4-2	Humanitarian Services
4-3	Personal Counseling
4-4	Preaching Missions Jewish Protestant Roman Catholic
4-5	Religion Jewish Protestant Roman Catholic
4-6	Religious Education
4-7	Retreats
4-8	Jewish

	Protestant
	Roman Catholic
4-9	Worship
5	Discipline and Conduct
5-1	Misconduct
	Administrative Reprimand
6	Identification
6-1	Change of Name
6-2	Foreign Nationals
6-3	Identification Cards
6-4	Passports and Visas
6-5	Serial Numbers
6-6	Tags
7	Military Personnel Records
7-1	Command Personnel Records Group
7-2	Field Personnel Records Group
7-3	Master Personnel Records Group
8	Pay and Allowances
8-1	Allotments
	Dependents
	Income Tax
	Pension
	Savings
8-2	Aviation Cadets
8-3	Benefits—Gratuities—Compensation
8-4	Clothing Allowances
8-5	Enlistment Bonus
8-6	Flying Pay
8-7	Inactive Duty Training Pay
8-8	Pay Withheld or Delayed
8-9	Quarters
8-10	Subsistence
8-11	Travel
9	Performance
9-1	Commendations
9-2	Decorations and Awards
9-3	Effectiveness Evaluation
10	Personnel Services (Welfare, Recreation, Morale)
10-1	Air Force Aid Society
10-2	American Red Cross
10-3	Bands and Music
10-4	Casualty Assistance
10-5	Casualty Reporting and Notification
10-6	Education
10-7	Entertainment and Recreation
10-8	Funerals and Burials
10-9	Library Services
	Library Property
	Operating Systems
	Technical Libraries
10-10	Personal Affairs
	Dependents Assistance
	Insurance
	Marriage
	Soldiers' and Sailors' Relief Act
10-11	Sports
11	Personnel Statistics
11-1	Morning Reports
11-2	Rosters

11-3	Strength
12	Political Activities
12-1	Voting
13	Prisoners of War
13-1	Allied
13-2	American
13-3	Enemy
14	Procurement
14-1	Appointment and Enlistment
	Examinations (Mental and Physical)
	Qualifications (Education and Physical)
	Waivers
14-2	Induction and Recall
	Draft Deferment
14-3	Recruiting
15	Promotion and Demotion
16	Rank and Precedence
17	Separation
17-1	Death
17-2	Discharge
17-3	Inactive Duty
17-4	Retirement
18	Uniforms (Regulations of Apparel)

Materiel Maintenance Engineering—MTN

1	Conservation Practices
2	Contractor Technical Assistance
3	Equipment Histories
4	Materiel Items
	(Further subdivide as required in accordance with standard classes of supply (AFM 67-1) using class numbers in parentheses as secondary subject designations, viz: MTN 4 (01).)
5	Modification
6	Performance Data
7	Preventive Maintenance
8	Repairs
9	Technical Order, Compliance
10	Unsatisfactory Reports

Operations—OPS

1	Air Bases, Use of
1-1	Domestic
1-2	Foreign
1-3	Site Surveys
2	Air Traffic Control
2-1	Aircraft Dispatch and Clearance
	Identification
2-2	Air Routes
2-3	Control Tower
2-4	Flight Rules and Regulations
2-5	Flight Safety
	Accidents
	Individual Flight Recording

- 3 Atomic Warfare
- 3-1 Liaison (Atomic Energy Commission, Military Liaison Committee, Armed Forces Special Weapons Project) (See also REL).
- 3-2 Maneuvers
- 3-3 Tests
- 4 Clandestine Operations
- 5 Electronics Systems
- 5-1 Airborne Radar
- 5-2 Aircraft Control and Warning Radar Calibration
- 5-3 Combat Electronics
- 6 Flight Operations
- 6-1 Airlifts
- 6-2 Air Ground Rescue
- 6-3 Air Sea Rescue
- 6-4 Bombardment
- 6-5 Evacuation
 - Disaster
 - Wounded (See Aeromedical Evacuation—MED)
- 6-6 Fighter
- 6-7 Ground Support
- 6-8 Reconnaissance
- 6-9 Transport
 - Inflight Refueling
- 6-10 Troop Carrier
- 6-11 Special Missions
- 7 Joint Operations
- 8 Navigation
- 8-1 Navigation Aids
- 9 Operations Analysis
- 10 War Plans
- 10-1 Combined War Plans
 - Foreign Military Assistance
- 10-2 Defense
 - Civil Defense
 - Mobilization
 - Civil Aviation
- 10-3 Joint War Plans
- 10-4 Logistics
- 10-5 Offense
 - Biological and Chemical
 - Psychological
 - Strategic
 - Tactical
 - Ground Support

Photography—PHO

- 1 Aerial Mapping and Charting Photography
- 1-1 Cross Servicing Agreements (Inter-Agency)
- 1-2 Identifications and Titling
- 1-3 Mapping and Charting Projects
- 1-4 Print Libraries
- 2 Motion Picture Photography
- 2-1 Distribution and Control of Projection Prints (Training and Information and other Education Films).

- 2-2 Gun Sight Aiming Point (GSAP)
- 2-3 Motion Picture Production Project
- 3 Radar Scope Photography
- 4 Sound Recording
- 5 Still Photography
- 5-1 Print Libraries
- 5-2 Transparencies
 - Film Strips
- 6 Use Requirements Review
- 6-1 Air Force Film Review Board
- 6-2 Intelligence Collection
- 6-3 Research Instrumentation and Documentation
 - Training
- 6-4 Utilization Control
- 7 Color Policy
- 7-1 Loan, Sales and Exchange
- 7-2 Terminology—Nomenclature

Police Operations—POL

- 1 Police Administration
- 1-1 Authority and Jurisdiction
- 1-2 Civil Police Liaison
- 1-3 Complaints
 - Individual Case Files
- 1-4 Disposition of Offender Reports
- 1-5 Gate Guarding
- 1-6 Offenses or Incidents
 - (Including Arrests and Routine Investigations of Delinquency and Complaints)
- 1-7 Patrolling
- 1-8 Permits (Hunting, Fishing, Firearms, etc.)
- 1-9 Property
- 1-10 Records of Events (Desk Journal)
- 1-11 Relief Schedules
- 1-12 Reports of PM Activities
- 1-13 State of Discipline
- 1-14 Traffic Control
- 1-15 Vehicle Registration
- 2 Corrections
 - 2-1 Casual Prisoners
 - 2-2 Confinement Administration
 - 2-3 Confinement Operations
 - 2-4 Prison Administration
 - 2-5 Prisoners Complaints
 - 2-6 Prisoner's Individual Records
 - 2-7 Restoration and Clemency
 - 2-8 Retraining of Prisoners

Procurement—PRO

- 1 Contract Administration
 - 1-1 Contractor's Records
 - 1-2 Cost Reimbursement (Approval of Cost)
 - 1-3 Price Redetermination (Renegotiation)
 - 1-4 Subcontracting
 - 1-5 Tax Exemption

- 2 Contract Financing
 - 2-1 Advance Payment
 - 2-2 Guaranteed Loans
 - 2-3 Partial Payments
- 3 Contract Placement
 - 3-1 Bonds
 - 3-2 Coordinated Procurement
 - 3-3 Execution (Awards)
 - Approval
 - Distribution
 - Numbering
 - 3-4 Formal Advertising
 - 3-5 Interdepartmental Procurement
 - Federal Supply Service
 - 3-6 Negotiation
 - Finding and Determinations
 - 3-7 Sources
 - Bidders List
 - Small Business
 - 3-8 Specifications
- 4 Contractual Instruments
 - 4-1 Changes
 - 4-2 Types
 - Cost-Plus-Fixed-Fee
 - Fixed Price
 - Time and Materials
- 5 Foreign Procurement
- 6 Government Property
 - 6-1 Bailment
 - 6-2 Government-Furnished Materials
 - Government-Furnished Aeronautical Equipment
 - 6-3 Industrial Property Control
- 7 Industrial Resources
 - 7-1 Facilities
 - Industrial Equipment
 - Plant Expansion
 - Special Tooling
 - 7-2 Labor and Technicians
 - 7-3 Materials
 - Controlled Materials
 - Customs Entry
 - Priorities
 - Stockpiling
- 8 Initiation of Purchase and Procurement Authority
 - 8-1 Assignment of Procurement Responsibility
 - 8-2 Delegation of Authority
 - 8-3 Procurement Directives
 - 8-4 Purchase Requests
- 9 Production
 - 9-1 Delivery Schedules
 - 9-2 Engineering Changes
 - 9-3 Expediting
- 10 Programming
 - 10-1 Requirements Computation
- 11 Procurement Case Files
- 12 Quality Control
 - 12-1 Inspection and Acceptance

- 13 Readjustment
 - 13-1 Claims
 - 13-2 Property Disposal
 - 13-3 Settlement
 - 13-4 Termination
 - Convenience
 - Default

Publishing and Publications—PUB

- 1 Orders
 - 1-1 AF Reserve Orders
 - 1-2 Courts-Martial Orders
 - 1-3 Flight Orders
 - 1-4 General Orders
 - 1-5 Movement Orders
 - 1-6 Operations Orders
 - 1-7 Personnel Action Memoranda
 - 1-8 Special Orders
 - 1-9 Technical Orders
- 2 Printing, Binding and Reproduction (Including Ditto, Photostat, etc.)
 - 2-1 Requirements
- 3 Publishing
 - 3-1 Distribution and Procurement
 - 3-2 Format and Editorial Policy
 - Bulletins
 - Digests
 - Directories
 - Indexes
 - Letters
 - Manuals
 - Memoranda
 - Periodicals
 - Regulations
- ~~2-3 Forms Standardization and Control~~
- 4 Review and Coordination

Research and Development—R&D

- 1 Aircraft
 - (Subdivide as required: amphibian; bomber; cargo and transport; convertiplane; fighter; glider; liaison; lighter-than-air; parasite; reconnaissance; rotary wing; and trainer).
 - 1-1 Aerodynamics (Exclusive of propellers and rotors)
 - Airfoils
 - Boundary Layer Control
 - Design Criteria
 - External and Internal Flow
 - Fluid Mechanics
 - Turbulence
 - Wind Tunnel Studies
 - 1-2 Alighting Gear
 - Antiskid Devices
 - Brakes
 - Cross-wind Landing Devices
 - Floats
 - Skis

	Steering		Deicing and Anti-icing Devices
	Tires		Fire Prevention Equipment
	Wheels		Heating Equipment
1-3	Components		Hydraulics
	Fuel Cells		Inflight Cargo Handling Equipment
	Fuselages		Oxygen Equipment
	Tail Assemblies		Pneumatic
	Wings	1-10	Propellers and Rotors
1-4	Design		Aerodynamics of
	Comfortization		Components
	Design Parameters		Control
	Escape and Recovery		Drive Mechanism
	Fabrication	1-11	Servicing and Handling
	Layout and Arrangement		Fueling and Fuel Storage
	Load, Weight and Balance		Gas Generators and Gas Servicing
	Passive Defense		Handling
	Performance		Heating and Air Conditioning
	Pressurization		Launchers and Arresters
	Structural Testing		Lubrication Equipment
1-5	Electrical Accessories		Mobile Compressed Air Supply
	Actuators		Starting
	Auxiliary Power Plants and Generators	1-12	Towing
	Circuit Breakers		Stability and Control
	Convertors		Control Mechanisms
	Lighting		Control Surfaces
	Motors		Criteria
	Regulators		Dynamic Load
	Storage Batteries		Flutter
	Wiring		Vibration
1-6	Flight Instruments	2	Armament
	Accelerometers	2-1	Aircraft Armor (Plates, Bullet Proof Glass, etc)
	Airspeed	2-2	Ammunition and Guns (Exclusive of Fire Control System)
	Altitude		Accessory Equipment
	Free Air Temperature		Destructive Effects
	Pitch and Yaw		Drives
1-7	Flight Operation Techniques and Equipment		Feed and Storage (Aboard Aircraft)
	Aircraft Climatization		Mounts
	All Weather Operation	2-3	Analysis and Evaluation
	Cruise Control		Ballistics
	Floating Wings		Computation
	Piloting		Control Theory
	Range		Dynamics of Systems
	Extension		Performance Evaluation
	Inflight Refueling		Systems Synthesis
	Towing	2-4	Bombs (Exclusive of Special Weapons)
	Unconventional Landing and Take-off		Cluster
1-8	Maintenance and Test		Controlled
	Engine Test Cells		Damage Assessment
	Engine Test Stands		Fragmentation
	Repair Equipment		General Purpose
	Shelters and Maintenance Stands		Incendiary
	Structure Testing Equipment		Leaflet
1-9	Mechanical Accessories		Photoflash
	Actuators		Target Marker
	Aerial Delivery Equipment	2-5	Bomb Accessories
	Aerial Dispensers		Anti-ricochet Devices
	Cooling and Air Conditioning		Fins

	Launchers		Screening
	Racks		Signal Search and Analysis
	Release Systems		Simulation
	Shackles	5-2	Components, Techniques and Tests
2-6	Computers		Amplification
	Bombing		Antennas and Antenna Shelters
	Ground Defense		Detection
2-7	Demolitions		Interference Reduction
	Application		Meters
	Techniques		Modulation
2-8	Fire Control Systems		Moving Target Identification
	(Position reference—radar; optics;		Remoting Devices
	gyros; computers; servo-transmit-		Signal Analysis
	ters; all equipment applicable to an		Signal Generators
	integrated fire control system)	5-3	Electromagnetics
2-9	Fuses		Analysis
2-10	Mines and Torpedoes		Wave Propagation
2-11	Munitions Handling Equipment	5-4	Electronic and Electrical Parts
	Cranes		Ammeters
	Hoists		Condensers
	Slings		Electronic Tubes
	Trailers		Heating Elements
	Trucks		Inductors
2-12	Rockets and Launchers		Insulation
	Accessory Equipment		Lamps
	Destructive Effects		Magnetic Amplifiers
	Feed and Storage (Aboard Aircraft)		Plugs and Connectors
	Launching Equipment		Regulators
	Release Equipment		Resistors
	Rockets		Transformers
2-13	Sights		Transistors
	Bombsights		Voltmeters
	Gunsights		Wire
2-14	Warheads	6	Engines
3	Chemistry		(Subdivide as required: gas turbines,
3-1	Analytical Physical		turbo jets and turboprops; nuclear; ram-
3-2	Inorganic		jet; rocket)
3-3	Organic	6-1	Engine Accessories
4	Communication		Carburetion and Manifolding
4-1	Accessories		Controls
4-2	Acoustics		Coolings
4-3	Airborne Systems		Filters and Screens
4-4	Facsimile		Fuel Systems
4-5	Ground Systems		Ignition
4-6	Linguistics		Injectors
4-7	Receivers		Lubrication and Systems
4-8	Recordings		Power Transmission
4-9	Telemetering	6-2	Engine Instruments
4-10	Teletype		Flowmeters
4-11	Television		Fuel Gauges
4-12	Theory of Information and Communica-		Position Indicators (cowl, inter-
	tion		cooler flaps, landing gear, etc.)
4-13	Transmitters		Tachometers
5	Electronics		Temperature
5-1	Combat Electronic Application (Elec-		Thrust Meters
	tronic Countermeasures)		Torqueometers
	Antijamming	7	Equipment
	Confusion	7-1	Air Base Equipment
	Ferret Systems		Auxiliary Power
	Jamming		Camouflage

	Construction and Maintenance Equipment	8-3	Hydraulic Fluids
	Fire, Crash and Salvage Equipment	8-4	Hydrocarbon Fuels
	Lighting and Marking	8-5	Oils
	Materials Handling	8-6	Rocket Fuels and Propellants
	Personnel Carriers	8-7	Storage and Distribution
	Structures	9	Guided Missiles
7-2	Clothing and Protective Equipment		(Subdivide as required: air to air; air to surface; air to underwater; surface to air; surface to surface; surface to underwater; underwater to air; underwater to surface; underwater to underwater.)
	Anti-hazard Clothing		Alighting Gear
	Environmental Clothing	9-1	Components, Accessories and Parts
	Eye Protection	9-2	Design
	Flying Clothing	9-3	Electrical Equipment
	Helmets	9-4	Instruments
	Occupational Clothing	9-5	Launching and Recovery Equipment
	Personal Armor	9-6	Mechanical Equipment
	Personal Oxygen Equipment	9-7	Stability and Control
	Protective Clothing	9-8	Test Vehicles
	Restraining Devices	9-9	
	Uniform	9-9	
7-3	Machine Elements and Hardware	10	Industrial Processes (bonding; cutting; fixtures; forming; finishings; gauges; inspection instruments; joining methods; packaging; preserving; tools; treatment; welding)
	Bearings		
	Cams		
	Fastenings		
	Fittings		
	Gears	11	Instrumentation
	Mechanical Servos	11-1	Aircraft
	Movements and Mechanisms	11-2	Armament
	Springs	11-3	Electronics
7-4	Medical and Dental Equipment	11-4	Guided Missiles
7-5	Rescue and Survival Equipment	11-5	Laboratory
	Aerial Pickup and Tow	11-6	Optical
	Airborne Land Rescue Equipment	11-7	Range
	Airborne Sea Rescue Equipment	11-8	Special Weapons
	Detection Devices	12	Materials
	Droppable Survival Gear	12-1	Chemicals
	Flotation Gear	12-2	Metallurgy and Metallics
	Personal Survival Clothing		Alloys
	Rescue Boats and Equipment		Ceramics and Metallic Mixtures
7-6	Test Support		Combination Metallic and Non-metallic Materials
	Aerial		Metallic Sandwich Materials
	Range		Powder Metallurgy
7-7	Trainers and Simulators	12-3	Non-metallics
	Air Vehicle Trainers		Adhesives and Sealers
	Bombing System Trainers		Ceramics
	Electronic Equipment Trainers		Elastomers
	Fire Control Trainers		Leather
	Navigation Trainers		Paints
	Targets and Scoring Devices		Plastics
7-8	Quartermaster Type Equipment	13	Mathematics and Computation
	Bedding	14	Medicine and Biology
	Cleaning and Sanitation Equipment	14-1	Air Evacuation
	Food and Rations	14-2	Allergy
	Food Containers and Dispensers	14-3	Anatomy
	Food Preparation Equipment	14-4	Aviation Medicine
	Furnishings	14-5	Bacteriology
	Personal Care Equipment	14-6	Biochemistry
	Shelters	14-7	Biomedical Aspects of Special Weapons
8	Fuels and Lubricants	14-8	Biophysics
8-1	Greases	14-9	Dentistry
8-2	High Energy Fuel		

- | | | | |
|-------|---|-------|--|
| 14-10 | Dermatology | | Inertial |
| 14-11 | Entomology | | Position Indicators |
| 14-12 | Epidemiology | 17-4 | Terminal Control of Air Vehicles |
| 14-13 | Immunology | | Air Traffic Control |
| 14-14 | Military and Field Medicine | | Ground-Controlled Approach |
| 14-15 | Neurology | | Homing |
| 14-16 | Neuropsychiatry | | Instrument Landing Systems |
| 14-17 | Ophthalmology | | Target Seekers |
| 14-18 | Orthopedics | 17-5 | Vehicle Guidance and Control |
| 14-19 | Otorhinolaryngology | | Beam Riding |
| 14-20 | Parasitology | | Close Cooperation Devices |
| 14-21 | Pathology | | Command Systems |
| 14-22 | Pharmacology | | LORAN |
| 14-23 | Physiology | | Preset Guidance |
| 14-24 | Preventive Medicine | | Radio Compass Auto-pilots and |
| 14-25 | Radiobiology | | Coupling to Beams |
| 14-26 | Radiology | | Radion-ranging |
| 14-27 | Surgery | | SHORAN |
| 14-28 | Toxicology | | Stabilization Devices |
| 14-29 | Veterinary Medicine | 18 | Parachutes (Cargo; decelerator; missile re- |
| 14-30 | Virology | | cover; personnel theory of) |
| 15 | Meteorology | 19 | Personnel Utilization |
| 15-1 | Atmospheric Hydrodynamics and Circu- | 19-1 | Assignment |
| | lation Temperature | 19-2 | Evaluation |
| 15-2 | Balloon Probing and Transport System | 19-3 | Human Engineering |
| 15-3 | Climatology | 19-4 | Manpower Accounting and Reporting |
| 15-4 | Micrometeorology | 19-5 | Manpower Supply and Requirements |
| 15-5 | Synoptic Techniques | 19-6 | Promotion |
| 15-6 | Thunderstorms | 19-7 | Psychology of Training |
| 15-7 | Visibility | 19-8 | Psychophysiology |
| 15-8 | Water, Clouds and Hydrometers | 19-9 | Selection |
| 15-9 | Weather Forecasting | 19-10 | Training and Education |
| 15-10 | Winds, Turbulence and Diffusion | 20 | Photography (Including Aerial Reconnaissance Collection) |
| 16 | Military Psychology | 20-1 | Interpretation and Compilation |
| 16-1 | Intelligence Operations Techniques | 20-2 | Processes and Devices |
| 16-2 | Psychological Warfare Methods | | Cameras |
| 17 | Navigation and Navigation Instruments and Equipment | | Emulsions |
| 17-1 | Ground Reference Navigation | | Film |
| | Direction Finding | | Lenses |
| | Distance and Position Finding | | Optical Material |
| | Ground Tracking Airborne Radar | | Optics |
| | Map Matching | | Photo Process Labs |
| | Radar Beacons and Markers | | Photosensitive Material and Processes |
| | Radar Search | | Printing |
| 17-2 | Navigation Instruments | | Processing |
| | Astrograph Data Boards | | Quality Control |
| | Chart Projection Methods | | Titling |
| | Chronometers | 20-3 | Techniques |
| | Computers | | High Speed |
| | Driftmeters | | Infra-red |
| | Graphic Instruments | | Micro |
| | Octants | | Motion |
| | Position Indicators | | Still |
| 17-3 | Self-Contained Navigation | | Three Dimensional |
| | Celestial | | Ultra-violet |
| | Celestial-Inertial | 21 | Physics |
| | Dead Reckoning | 21-1 | Acoustics |
| | Direction Instruments | 21-2 | Electricity and Magnetics |

- 21-3 Experimental Physics
- 21-4 Mathematical Physics
- 21-5 Mechanics
- 21-6 Nuclear, Atomic, Molecular Structure
- 21-7 Solid State Physics
- 21-8 Thermodynamics
- 22 Physics (Atmospherics)
 - 22-1 Acoustics
 - 22-2 Cloud Physics and Nucleation
 - 22-3 Cosmic and Solar Influences
 - 22-4 Electricity and Ionization
 - 22-5 Meteors
 - 22-6 Optics
 - 22-7 Radiation
 - 22-8 Structure and Composition
- 23 Sociology
 - 23-1 Demography
 - 23-2 Inter-group and Inter-personnel Relations
 - 23-3 Morale and Leadership
- 24 Special Weapons, Effects and Defense
 - 24-1 Atomic Weapons
 - 24-2 Bacteriological and Biological Warfare Agents
 - 24-3 Chemical Warfare Agents (CW)
 - 24-4 Radiological Warfare Agents (RW)
 - 24-5 Thermonuclear Weapons
- 25 Terrestrial Sciences
 - 25-1 Geodesy
 - 25-2 Geology
 - 25-3 Geomagnetisms
 - 25-4 Geophysical Aspects of Atomic Weapons
 - 25-5 Oceanography
 - 25-6 Seismology
 - 25-7 Soil Mechanics

Relations & Liaison—REL

- 1 Information Services
 - 1-1 Civil Liaison
 - Community Relations
 - Celebrations and Ceremonies
 - Holiday Observances
 - Industrial Liaison
 - Speakers Bureau
 - 1-2 Internal Information
 - Base Newspapers
 - Commander's Call
 - Orientation
 - 1-3 Public Information
 - Information Releases
 - Press Queries
 - Press Visits
- 2 International Affairs
 - 2-1 NATO
 - 2-2 SHAPE
- 3 Legislative Relations
 - 3-1 Congressional Inquiries
 - 3-2 Legislation (Proposed-Submitted for Comment)
 - 3-3 Legislative Programs

Security—SEC

- 1 Counter Intelligence
 - 1-1 Subversive Activities (See INV 5)
 - Individuals
 - Organizations
- 2 Physical Security
 - 2-1 Travel Control
 - Security of Troop Movements (Personnel)
 - Security of Materiel Movements (Supply)
 - 2-2 Control of Entry and Exit
 - Guarding and Patrolling (Guarding and Patrolling Operations—See POL 1)
 - Identification and Passes
 - Physical Safeguards
 - Barriers, Devices and Equipment
 - Visitor Control
- 3 Safeguarding Military Information
 - 3-1 Censorship
 - Civil
 - Military
 - Prisoner-of-War
 - 3-2 Classifying and Marking
 - 3-3 Destruction (Incineration and Maceration)
 - 3-4 Disclosure and Access
 - 3-5 Handling and Transmission
 - 3-6 Loss or Subjection to Compromise
 - 3-7 Reproduction
 - 3-8 Storage

Supply and Services—SUP

- 1 Distribution of Supplies
 - 1-1 Basis of Issue
 - Accountability
 - Foreign Government
 - Loan, Donation and Exchanges
 - Organization Units
 - Rations
 - UPREELs
 - Personnel
 - Rations
 - Tables of Allowances
 - 1-2 Requirements
 - Discrepancies
 - Shortage
- 2 Disposition of Supplies and Personal Property (Disposition of Real Estate—See INS)
 - 2-1 Excess and Surplus Personal Property
 - Declaration
 - Redistribution
 - Sale
 - Salvage
- 3 Services
 - 3-1 Clothing Sales
 - 3-2 Commissary Operations

- | | | | |
|-----|---|-----|--|
| 3-3 | Food Services | 4-2 | Chemical Warfare |
| | Menus | 4-3 | First Aid |
| 3-4 | Laundry and Dry Cleaning | 4-4 | Physical |
| 3-5 | Mortuary and Grave Registration | 4-5 | Small Arms, Familiarization |
| | Escorts and Honors | 5 | Flying Training & Facilities (Schools) |
| | Headstones and Markers | 5-1 | Basic |
| | Interments and Disinterments | 5-2 | Bombardment |
| 3-6 | Post Exchange Operations | 5-3 | Fighter |
| 4 | Storage of Supplies | 5-4 | Instrument |
| 4-1 | Stock Control—Stock Record Account | | GCA (Ground Control Approach) |
| | Inventory and Adjustments | | ILS (Instrument Landing) |
| | Memorandum Receipts | 5-5 | Navigation |
| | Notice of Shipment | 5-6 | Reconnaissance |
| | Requisitions | 5-7 | Rotary Wing |
| | Service Stock (Model, Shop Stock,
Local Issue) | 5-8 | Tactical |
| | Shipping Documents | 6 | Foreign Trainees |
| | Stock Level Control | 7 | Military Training |
| | Vouchers | 7-1 | Basic Training (Non-flying) |
| 4-2 | Warehousing (Including Open Storage) | 7-2 | Officer Training (Non-flying) |
| | Preservation and Storage Methods | 8 | Professional and Academic Training and Fa-
cilities (Schools) |
| | Space Utilization | 8-1 | Academic |
| 5 | Supply System Management | 8-2 | Chaplains |
| 5-1 | Classification, Cataloging and Nomen-
clature | 8-3 | Dental |
| 5-2 | Conservation and Rationing | 8-4 | Legal |
| 5-3 | Export Control | 8-5 | Medical |
| | Seizure | 9 | Technical Training and Facilities (Schools) |
| 5-4 | Packaging and Marking | 9-1 | Career Training |
| 5-5 | Selection, Adaptation and Modification | | Atomic Warfare |
| | Standardization | | Biological Warfare |
| | Utilization | | Intelligence |
| 5-6 | Stockpiling and Reserves | 9-2 | Mobile Training |
| | Strategic and Critical Materials | 9-3 | On-the-job-training |
| 5-7 | Supply Directives | 9-4 | Special Training |
| 5-8 | Supply Facilities | 10 | Training Aids |
| | Base | 11 | Unit Training |
| | Depot | | |
| | Unit | | |
| 6 | Supply Items | | |
| | (Further subdivide as required in ac-
cordance with standard classes of supply
(AFM 67-1) using class numbers in
parentheses as secondary subject desig-
nations, viz: SUP 6 (01).) | | |

Training—TNG

- | | |
|-----|---|
| 1 | Administrative Training and Facilities
(Schools) |
| 1-1 | Administrative Procedures |
| 1-2 | Management Training |
| 1-3 | Secretarial Training |
| 2 | Air Academy |
| 3 | Civilian Components |
| 3-1 | Air Force Reserve |
| 3-2 | Air National Guard |
| 3-3 | Civil Air Patrol |
| 4 | Collateral Training |
| 4-1 | Aircraft Recognition |

Transportation—TRS

- | | |
|-----|---|
| 1 | Baggage and Trophies |
| 2 | Commercial |
| 2-1 | Carrier Agreements |
| 2-2 | Carrier Representation |
| 2-3 | Freight (Facilities, Classification and
Rates) |
| | Air |
| | Bills of Lading |
| | Chemicals, Explosive and Inflamm-
ables |
| | Demurrage |
| | Diversion and Reconsignment |
| | Embargoes |
| | Express |
| | Forwarding and Loading |
| | Household Goods |
| | Motor Carriers |
| | Rail |
| | Car Control and Supply |
| | Storage in Transit |

	Water	5	Military Motor Vehicles
	Weighing and Inspection	5-1	Base Authorized Allowances
2-4	Loss and Damages	5-2	Bus Movements
2-5	Military Impedimenta	5-3	Drivers Qualification and Training
2-6	Passenger (Facilities, Classification and Rates)	5-4	General Purposes
	Air		Administration
	Civilian Personnel	5-5	Tactical
	Dependents	5-6	Operations
	Military Personnel	5-7	Special Movement Authorizations
	Remains	5-8	Special Purpose
	Itineraries and Reservations	6	Tolls
	Motor Carrier	6	Military Sea Transport
	Personally Owned Auto	6-1	Billing Procedures (MSTS)
	Rail	6-2	Cargo
	Subsistence		Outturn Reports
	Superior Accommodations		Overseas Destination
	Transportation Requests		England
	Troop Movements		Germany
	Sleeping Accommodations		Others
	Water		Special Cargo
2-7	Routes		Aircraft
2-8	Strikes		Privately Owned Automobiles
2-9	Switching		Z. I. Ports
3	Customs Entry		HRPE
4	Military Air Transport		NOPE
4-1	Ferrying of Aircraft		NYPE
4-2	Integration of Commercial Facilities		SEPE
	Charters	6-3	SFPE
	Contracts	6-3	Monthly Reports (MSTS)
	Ground Detention	6-4	Passengers
	Regulations (Operating Rights, CAB Proceedings, etc.)		Civilian
4-3	Lost or Destroyed Aircraft (Cargo and/or Personnel in)		Dependent
4-4	Non-Revenue Traffic		Military
	Cargo		Retired Personnel
	Mail		Space Available
	Passengers	6-5	Port Detachments
	Civilian	6-6	Stevedoring
	Dependent	7	Illegal Use of Transport
	Military	8	Insurance
	Retired, Reserve, ROTC	9	Travel Control (Priorities)
4-5	Revenue Traffic	10	Utility Boats
	Cargo		
	Passenger		
4-6	Traffic Regulations		
	Capabilities and Allocations		
	Clearances		
	Documentation		
	MAP Traffic		
	NATO Traffic		
	UN Traffic		
			Weather—WEA
		1	Geographical Requirements
		1-1	Techniques and Equipment
		2	Meteorological Analysis
		2-1	Climatology
		2-2	Forecasting
			Storm Tracking—Warning
		3	Observations
		3-1	Air Reconnaissance
		3-2	Surface (Weather Stations)

RELATIVE INDEX

A

Absence: (Leave)			
Civilian.....	CIV	10	
Annual.....	CIV	10-1	
Sick.....	CIV	10-2	
Without Pay.....	CIV	10-3	
Military.....	MIL	1	
Desertion.....	MIL	1-2	
Emergency.....	MIL	1-3	
Without Leave (AWOL).....	MIL	1-1	
Academic:			
Schools.....	TNG	8-1	
Training.....	TNG	8-1	
Academy, Air.....	TNG	2	
Acceptance and Inspection, Quality Control.....	PRO	12-1	
Access, Military Information.....	SEC	3-4	
Accession, Civilian Personnel.....	CIV	1	
Accessories:			
Aircraft:			
Electrical.....	R&D	1-5	
Mechanical.....	R&D	1-9	
Bomb.....	R&D	2-5	
Communications.....	R&D	4-1	
Engine.....	R&D	6-1	
Guided Missiles.....	R&D	9-2	
Accidents, Ground Safety.....	MGT	3	
Account, Stock Record.....	SUP	4-1	
Accounting:			
Appropriation.....	FIN	1	
Cost.....	FIN	5	
Expense.....	FIN	6	
General Ledger.....	FIN	7	
International.....	FIN	8	
Manpower (Utilization).....	R&D	19-4	
Monetary Property.....	FIN	9	
Procedures:			
Expense Accounting.....	FIN	6-1	
General Ledger Accounting.....	FIN	7-1	
Salvage and Surplus Material.....	FIN	13	
Accounts:			
Communication.....	COM	1-1	
Cost.....	FIN	5	
Cryptography.....	COM	2-1	
Expense.....	FIN	6	
General Ledger.....	FIN	7	
Acoustics:			
Communications.....	R&D	4-2	
Physics.....	R&D	21-1	
Atmospherics.....	R&D	22-1	
Acquisition, Real Estate.....	INS	4-1	
Act, Civil Relief.....	LEG	3-1	
Action, Disciplinary.....	CIV	4-1	
Activation.....	MGT	8-1	
Activities:			
PM Report of.....	POL	1-12	
Cultural (Chaplains).....	MIL	4-1	
Political:			
Civilian.....	CIV	4-3	
Military.....	MIL	12	
Subversive.....	SEC	1-1	
Adjustments, Inventory of:			
Supplies.....	SUP	4-1	
Administration:			
Auditing.....	FIN	2-1	
Confinement.....	POL	2-2	
Contract.....	PRO	1	
Dental Clinic.....	MED	2-1	
Dispensary.....	MED	4	
Financial.....	FIN		
Funds (Budget).....	FIN	4-1	
Hospital.....	MED	4	
Legal.....	LEG		
Military Justice.....	LEG	1	
Pay:			
Civilian.....	CIV	11	
Military.....	MIL	8	
Personnel:			
Civilian.....	CIV		
Military.....	MIL		
Police.....	POL	1	
Prison.....	POL	2-4	
Administrative:			
Functions.....	MGT	2	
Inspections.....	INV	1	
Management:			
Charts.....	MGT	2-2	
Procedures, Training in.....	TNG	1-1	
Responsibilities.....	MGT	2	
Schools.....	TNG	1	
Training.....	TNG	1	
Visits.....	INV	1	
Advance Payment of Contracts.....	PRO	2-1	
Advertising-Formal Contracts.....	PRO	3-4	
Aerial Mapping and Charting.....	PHO	1	
Aerodynamics, Aircraft.....	R&D	1-1	
Aeromedical Evacuation.....	MED	1	
Aeronautical Information Publications.....	MAP	1	
Affairs:			
International Relations.....	REL	2	
Personal.....	MIL	10-10	
Agencies, Ecclesiastical:			
Indorsing (Chaplains).....	MIL	4-2	
Agreements:			
Carrier.....	TRS	2-1	

Exchange.....	MAP 6		
International Accounting.....	FIN 8-1		
Photography (Cross Servicing).....	PHO 1-1		
Aid Society, Air Force.....	MIL 10-1		
Aids:			
Navigation Operations.....	OPS 8-1		
Training.....	TNG 10		
Facilities.....	INS 1-12		
Air:			
Academy.....	TNG 2		
Attaches.....	INT 1-1		
Base Equipment.....	R&D 7-1		
Bases, Use of.....	OPS 1		
Control Tower.....	OPS 2-3		
Crew Effectiveness.....	MED 3-1		
Evacuation.....	R&D 14-1		
Facilities, Intelligence Estimates of.....	INT 2-1		
Ground Rescue.....	OPS 6-2		
Materiel Estimates.....	INT 2-2		
National Guard Training.....	TNG 3-2		
Order of Battle.....	INT 2-3		
Reconnaissance.....	WEA 3-1		
Routes:			
Operations.....	OPS 2-2		
Sea Rescue.....	OPS 6-3		
Target Materials.....	MAP 2		
Traffic Control.....	OPS 2		
Transport Service.....	TRS 4		
Vehicles, Terminal Control.....	R&D 17-4		
Air Force:			
Aid Society.....	MIL 10-1		
Film Review Board.....	PHO 6-1		
Personnel Assigned to other US Armed Services and other Countries.....	MIL 2-1		
Reserve:			
Orders.....	PUB 1-1		
Training.....	TNG 3-1		
With other Countries, Reassignment of.....	MIL 2-1		
Airborne:			
Communications Systems.....	COM 3-1		
Research.....	R&D 4-3		
Radar Operations.....	OPS 5-1		
Aircraft:			
Armor (Armament).....	R&D 2-1		
Clearance (Traffic).....	OPS 2-1		
Control.....	OPS 5-2		
Crash Rescue (Facilities).....	INS 1-5		
Dispatch (Traffic).....	OPS 2-1		
Ferrying of.....	TRS 4-1		
Instrumentation.....	R&D 11-1		
Lost or Destroyed.....	TRS 4-3		
Research.....	R&D 1		
Warning.....	OPS 5-2		
Airfields.....	INS 1-1		
Airlifts, Operations of.....	OPS 6-1		
Alighting Gear: (Research)			
Aircraft.....	R&D 1-2		
Guided Missiles.....	R&D 9-1		
Allergy.....	R&D 14-2		
Allied, Prisoners of War.....	MIL 13-1		
Allocation:			
Advice of.....	FIN 1-2		
Funds.....	FIN 1-2		
Status of.....	FIN 1-2		
Allotments:			
Advice of.....	FIN 1-2		
Pay.....	MIL 8-1		
Allowances:			
Clothing.....	MIL 8-4		
Pay.....	MIL 8		
Quarters.....	MIL 8-9		
Subsistence.....	MIL 8-10		
Vehicles (Base).....	TRS 5-1		
Amateur Radio.....	COM 3-2		
American:			
Prisoners of War.....	MIL 13-2		
Red Cross:			
Contributions to.....	ADM 3		
Services of.....	MIL 10-2		
Ammunition, Armament.....	R&D 2-2		
Anatomy (Research).....	R&D 14-3		
Analysis:			
Armament.....	R&D 2-3		
Meteorological.....	WEA 2		
Operations.....	OPS 9		
Organizational.....	MGT 6-2		
Program.....	MGT 6-3		
Target.....	INT 4-2		
Analytical Physical (Chemistry).....	R&D 3-1		
Annexes (Intelligence).....	INT 1-9		
Annual:			
Budget Authorizations.....	FIN 1-3		
Financial Plan.....	FIN 4-1		
Appeals, Civilian Personnel.....	CIV 12-3		
Appellate, Review and Procedure.....	LEG 1-1		
Application for Employment.....	CIV 15-1		
Appointment, Military.....	MIL 14-1		
Approach Charts.....	MAP 13-1		
Appropriation:			
Accounting.....	FIN 1		
Law.....	FIN 4-1		
Approval of Cost (Contracts).....	PRO 1-2		
Aprons (Facilities).....	INS 1-1		
Armament.....	R&D 2		
Analysis.....	R&D 2-3		
Instrumentation.....	R&D 11-2		
Armed Forces Special Weapons Project, Liaison with.....	OPS 3-1		
Armed Services with AF:			
Assignment of.....	MIL 2-2		
Reassignment of.....	MIL 2-2		
Armor, Aircraft.....	R&D 2-1		
Arrests.....	POL 1-6		
Assignment:			
Attached.....	MIL 2-3		
Military Personnel.....	MIL 2		
Organizational Units.....	MGT 8-2		
Permanent Change of.....	MIL 2-5		
Personnel Utilization, Research on.....	R&D 19-1		
Procurement Responsibility.....	PRO 8-1		

Assistance:	
Contractor, Technical.....	MTN 2
Legal.....	LEG 3
Atmospheric Hydrodynamics	
Temperature (Meteorology).....	R&D 15-1
Atomic:	
Energy Commission, Liaison with.....	OPS 3-1
Structure, Physics.....	R&D 21-6
Warfare.....	OPS 3
Liaison.....	OPS 3-1
Maneuvers.....	OPS 3-2
Schools.....	TNG 9-1
Tests.....	OPS 3-3
Training.....	TNG 9-1
Weapons (Effects and Defense).....	R&D 24-1
Attorney, Power of.....	LEG 3-2
Auditing.....	FIN 2
Auditor's Records.....	FIN 2-2
Audits:	
Contract.....	FIN 2-3
Industrial.....	FIN 2-3
Internal.....	FIN 2-4
Intra-Air Force.....	FIN 2-4
Authority:	
Delegation of.....	MGT 2-4
Procurement.....	PRO 3-2
Designation of.....	MGT 2-4
Initiation of Purchase.....	PRO 8
Police.....	POL 1-1
Procurement.....	PRO 8
Authorizations:	
Annual Budget.....	FIN 1-3
Frequency (Radio).....	COM 4-4
Special Movement.....	TRS 5-6
Aviation:	
Cadet Pay.....	MIL 8-2
Medicine.....	MED 7-1
Research.....	R&D 14-4
Awards:	
Civilian.....	CIV 12-1
Contract.....	PRO 3-3
Military.....	MIL 9-2

B

Bacteriology Research.....	R&D 14-5
Baggage, Transportation of.....	TRS 1
Bailment, Property.....	PRO 6-1
Balloon Probing and Transport	
System (Meteorology).....	R&D 15-2
Bands (Service).....	MIL 10-3
Banking.....	FIN 3
Base:	
Authorized Allowances, Vehicles.....	TRS 5-1
Supplies, Facilities.....	SUP 5-8
Trust Funds.....	FIN 10-3
Veterinary Service.....	MED 8
Bases, Air (Use of).....	OPS 1

Basic:

Flying:	
Schools.....	TNG 5-1
Training.....	TNG 5-1
Training (Nonflying).....	TNG 7-1
Basis of Issue, Supplies.....	SUP 1-1
Bacteriological Warfare Agents.....	R&D 24-2
Battle:	
Air Order of.....	INT 2-3
Casualties.....	MED 3-2
Benefits.....	MIL 8-3
Billing Procedures, MSTs.....	TRS 6-1
Binding (Publications).....	PUB 2
Requirements.....	PUB 2-1
Biochemistry Research.....	R&D 14-6
Biological:	
Defense, Preventive Medicine.....	MED 6-1
Warfare	
Agents.....	R&D 24-2
Schools.....	TNG 9-1
Training.....	TNG 9-1
Biology Research.....	R&D 14
Biomedical Aspects of Special Weapons.....	R&D 14-7
Biophysics Research.....	R&D 14-8
Boards, Civil Service Examiners.....	CIV 15-2
Boats, Utility.....	TRS 10
Bomb Accessories, Research.....	R&D 2-5
Bombardment:	
Flying:	
Schools.....	TNG 5-2
Training.....	TNG 5-2
Operations.....	OPS 6-4
Bombs, Armament (Research).....	R&D 2-4
Bonds:	
Contract.....	PRO 3-1
Savings.....	FIN 11
Surety.....	FIN 15
Bonus, Enlistment.....	MIL 8-5
Book:	
Department Funds.....	FIN 10-1
Briefing, Intelligence.....	INT 1-2
Budget:	
Air Force Code.....	FIN 4-2
Annual Authorizations.....	FIN 1-3
Estimates.....	FIN 4-3
Federal.....	FIN 4-4
Office.....	ADM 2
Program Management.....	FIN 4-1
Structures.....	FIN 4-2
Budgeting.....	FIN 4
Office.....	OFF 2
Building Equipment.....	INS 1-2
Buildings.....	INS 1-3
Burial:	
Civilian.....	CIV 5
Military.....	MIL 10-8
Bus Movements.....	TRS 5-2

C

Call for Estimates.....	FIN 4-3	Development of	
Campaigns:		Aeronautical.....	MAP 4
Charity.....	ADM 3	Distribution of	
Public Interest.....	ADM 3	Aeronautical.....	MAP 5
Capabilities, Estimates.....	INT 2-4	Equidistant.....	MAP 13-5
Capacity, Hospital (Beds).....	MED 4-1	Evasion.....	MAP 13-6
Captured Materiel.....	INT 1-3	Experimental.....	MAP 4-1
Cards, Identification.....	MIL 6-3	Hydrographic.....	MAP 7
Career Development:		Navigation.....	MAP 13-7
Civilian.....	CIV 2	Organizational.....	MGT 7-4
Military.....	MIL 3	Planning, Aeronautical.....	MAP 13-2
Cargo:		Portrayal.....	MAP 4-2
MATS		Presentation.....	ADM 4
Non-Revenue.....	TRS 4-4	Radar Tracking.....	MAP 13-8
Revenue.....	TRS 4-5	Radio Facility.....	MAP 1-5
MSTS.....	TRS 6-2	Special.....	MAP 12
Carrier:		Standard Series.....	MAP 13
Agreements.....	TRS 2-1	Stocking of (Aero Charts).....	MAP 3
Representation.....	TRS 2-2	Strategic.....	MAP 13-9
Troop (Operations).....	OPS 6-10	Target.....	MAP 2-4
Casual Prisoners.....	POL 2-1	Test and Evaluation Aero Charts.....	MAP 4-3
Casualties, Battle.....	MED 3-2	Weather.....	MAP 13-10
Casualty:		World, Aeronautical.....	MAP 13-11
Assistance.....	MIL 10-4	Check, Flight (Radio).....	COM 4-3
Notification.....	MIL 10-5	Chemical Warfare:	
Reporting.....	MIL 10-5	Agents.....	R&D 24-3
Cataloging Supplies.....	SUP 5-1	Schools.....	TNG 4-2
Celebrations, Public.....	REL 1-1	Training.....	TNG 4-2
Censorship.....	SEC 3-1	Chemicals, Materiel.....	R&D 12-1
Center Operations:		Chemistry.....	R&D 3
Communications.....	COM 1	Circulation Temperature.....	R&D 15-1
Relay.....	COM 1-3	Civil:	
Central:		Air Patrol Training.....	TNG 3-3
Funds:		Liaison.....	REL 1-1
Base.....	FIN 10-3	Police.....	POL 1-2
Mess.....	FIN 10-2	Relief Act.....	LEG 3-1
Welfare.....	FIN 10-3	Service Examiners, Board of.....	CIV 15-2
Ceremonies, Public.....	REL 1-1	Civilian:	
Certification, Civilian Payrolls.....	FIN 11	Burials.....	CIV 5
Change of Name.....	MIL 6-1	Career Development.....	CIV 2
Changes:		Components Training.....	TNG 3
Contracts.....	PRO 4-1	Death.....	CIV 5
Engineering.....	PRO 9-2	Demotion.....	CIV 14
Chaplaincy.....	MIL 4	Detailing Employees.....	CIV 6
Chaplains:		Draft Deferment.....	MIL 14-2
Funds.....	FIN 10-2	Loyalty Investigations.....	INV 5-1
Schools.....	TNG 8-2	Morale.....	CIV 7-6
Training.....	TNG 8-2	Passports.....	CIV 18-1
Charges, Statement of.....	FIN 14	Payroll Operations.....	FIN 11
Charity Campaigns.....	OFF 3	Placement.....	CIV 15
Charting:		Promotion.....	CIV 14
Photography.....	PHO 1	Recreation.....	CIV 7-6
Projects.....	PHO 1-3	Recruitment.....	CIV 15
Charts:		Security Investigations.....	INV 5-1
Approach.....	MAP 13-1	Separation.....	CIV 17
Cloth.....	MAP 13-3	Travel.....	CIV 18
Crash Grid.....	MAP 13-4	Visas.....	CIV 18-1
		Welfare Funds.....	FIN 10-3
		Claims:	
		Accounting.....	FIN 1-4
		Civilian Employees.....	CIV 11-1

Legal.....	LEG 2	Center Operations.....	COM 1
Readjustment.....	PRO 13-1	Collection (Interception of Intelligence Information).....	INT 1-5
Clandestine:		Cryptosecurity.....	COM 2-1
Operations.....	OPS 4	Plant-in-Place (Facilities).....	COM 4-5
Sources (Information).....	INT 1-4	Relay Centers.....	COM 1-3
Classification:		Research.....	R&D 4
Career, Military.....	MIL 3-1	Security.....	COM 2
Position, Civilian.....	CIV 13	Crypto.....	COM 2-1
Supplies.....	SUP 5-1	Physical.....	COM 2-2
Classifying (Security).....	SEC 3-2	Transmission.....	COM 2-3
Clearance, Aircraft.....	OPS 2-1	Systems.....	COM 3
Clemency:		Airborne.....	COM 3-1
Corrections.....	POL 2-7	Research.....	R&D 4-3
Legal.....	LEG 1-2	Compensation	
Climatology.....	WEA 2-1	Death, for.....	CIV 3
Research.....	R&D 15-3	Injury, for.....	CIV 3
Clinical Records.....	MED 4-2	Pay.....	MIL 8-3
Clinics:		Compilation, Photography.....	R&D 20-1
Dental Administration.....	MED 2-1	Complaints:	
Dietary.....	MED 7-2	Investigation of.....	INV 2
Medical.....	MED 7-4	Police, to.....	POL 1-3
Professional.....	MED 7	Prisoners.....	POL 2-5
Surgical.....	MED 7-8	Compliance, Technical Orders.....	MTN 9
Clothing:		Components:	
Allowances.....	MIL 8-4	Aircraft, Research on.....	R&D 1-3
Equipment, Research.....	R&D 7-2	Civilian Training (Reserve).....	TNG 3-1
Sales Services.....	SUP 3-1	Electronics, Research on.....	R&D 5-2
Clouds:		Guided Missiles Research.....	R&D 9-2
Atmospheric Physics.....	R&D 22-2	Composition, Atmospheric Physics.....	R&D 22-8
Meteorology.....	R&D 15-8	Computation.....	R&D 13
Codes, Radar Return.....	MAP 2-2	Computers, Armament.....	R&D 2-6
Collateral Training.....	TNG 4	Conduct:	
Collections:		Civilians.....	CIV 3-4
Accounting, Appropriation.....	FIN 1-5	Disciplinary Actions.....	CIV 4-1
Intelligence.....	INT 1	Favors and Gratuities.....	CIV 4-2
Refuse.....	INS 1-10	Military.....	MIL 5
Color Policy, Photography.....	PHO 7-1	Conference Rooms.....	ADM 8-1
Combat:		Confinement:	
Electronics.....	OPS 5-3	Administration.....	POL 2-2
Applications (Research).....	R&D 5-1	Operations.....	POL 2-3
Combined War Plans.....	OPS 10-1	Congressional Inquiries.....	REL 3-1
Command:		Conservation:	
Jurisdiction.....	MGT 2-3	Practices.....	MTN 1
Personnel Records.....	MIL 7-1	Supplies.....	SUP 5-2
Prerogatives.....	MGT 2-3	Constitution of Organizations.....	MGT 8-3
Welfare Funds.....	FIN 10-3	Construction:	
Commendations		Facilities.....	INS 1
Civilian.....	CIV 12-1	Planning.....	INS 3-1
Military.....	MIL 9-1	Contract:	
Commercial:		Administration.....	PRO 1
Facilities:		Changes.....	PRO 4-1
Integration of.....	TRS 4-2	Financing.....	PRO 2
Radio.....	COM 4-1	Placement.....	PRO 3
Transportation.....	TRS 2	Specifications.....	PRO 3-8
Freight.....	TRS 2-3	Types.....	PRO 4-2
Commissary Operations.....	SUP 3-2	Contractor:	
Commitments (Financial).....	FIN 1-6	Employees:	
Communications.....	COM	Loyalty.....	INV 5-2
Accounts.....	COM 1-1	Security.....	INV 5-2
Amateur Radio.....	COM 3-2	Loyalty.....	INV 5-3

Records.....	PRO 1-1
Security.....	INV 5-3
Technical Assistance.....	MTN 2
Contractual Instruments.....	PRO 4
Control:	
Air Traffic.....	OPS 2
Aircraft.....	OPS 5-2
Auditing.....	FIN 2-1
Entry and Exit.....	SEC 2-2
Export.....	SUP 5-3
Forms.....	PUB 3-9
Guided Missiles.....	R&D 9-8
Industrial Property.....	PRO 6-3
Insects.....	INS 1-7
Message.....	COM 1-2
Projection Prints.....	PHO 2-1
Quality (Contracts).....	PRO 12
Rodent.....	INS 1-7
Space.....	ADM 8
Stations (Radio and Wire).....	COM 4-2
Stock.....	SUP 4-1
Levels.....	SUP 4-1
Tower Operations.....	OPS 2-3
Traffic.....	POL 1-14
Travel:	
Priorities.....	TRS 9
Security.....	SEC 2-1
Utilization (Photography).....	PHO 7
Vehicle, Air, Research on.....	R&D 17-5
Vermin.....	INS 1-7
Visitors (Security).....	SEC 2-2
Controlled Materials.....	PRO 7-3
Coordinated Procurement.....	PRO 3-2
Coordination, Publications.....	PUB 4
Copyrights.....	LEG 5-1
Corrections.....	POL 2
Correspondence Practices.....	MGT 1-1
Cosmic, Influence.....	R&D 22-3
Cost:	
Accounting.....	FIN 5
Reimbursement Contracts.....	PRO 1-2
Counseling (Chaplains).....	MIL 4-4
Counter Intelligence.....	SEC 1
Courier:	
Equipment.....	MGT 9-7
Service.....	MGT 9
System.....	MGT 9-1
Transfer Stations (CTS).....	MGT 9-1
Courts-Martial:	
General.....	LEG 1-3
Orders.....	PUB 1-2
Special.....	LEG 1-4
Summary.....	LEG 1-5
Crash Rescue, Air (facilities).....	INS 1-5
Criminal Investigations.....	INV 3
Cryptography Accounts.....	COM 2-1
Cryptosecurity.....	COM 2-1
Cultural Activities (Chaplains).....	MIL 4-1
Currency.....	FIN 3
Custodial Services.....	INS 1-4

Customs Entry.....	TRS 3
Material.....	PRO 7-3

D

Damages, Transportation.....	TRS 2-4
Data, Performance (Materiel).....	MTN 6
Data Sheets:	
Geodetic.....	MAP 2-1
Reliability (Air Target).....	MAP 2-3
Death:	
Civilian.....	CIV 5
Compensation for.....	CIV 3
Separation by.....	MIL 17-1
Decorations.....	MIL 9-2
Deductions, Retirement.....	FIN 11
Defense:	
Biological (Medicine).....	MED 6-1
War Plans.....	OPS 10-2
Delayed Pay.....	MIL 8-8
Delegation of Authority.....	MGT 2-4
Procurement.....	PRO 8-2
Delivery Schedules.....	PRO 9-1
Demography, Sociology.....	R&D 23-1
Demolitions.....	R&D 2-7
Demotions:	
Civilian.....	CIV 14
Military.....	MIL 15
Dental:	
Clinic Administration.....	MED 2-1
Equipment (Research).....	R&D 7-4
Health Records.....	MED 2-2
Schools.....	TNG 8-3
Special Materials.....	MED 2-6
Training.....	TNG 8-3
Treatment.....	MED 2-7
X-Ray.....	MED 2-3
Dentistry.....	MED 2
Preventive.....	MED 2-4
Research.....	R&D 14-9
Depot:	
Cost Accounting.....	FIN 5-2
Facilities.....	SUP 5-8
Dermatology, Research.....	R&D 14-10
Desertion.....	MIL 1-2
Design:	
Aircraft.....	R&D 1-4
Criteria (Construction).....	INS 3-2
Guided Missiles.....	R&D 9-3
Designation:	
Authority.....	MGT 2-4
Organization.....	MGT 8-4
Desk Journal.....	POL 1-10
Destroyed:	
Aircraft:	
Cargo.....	TRS 4-3
Lost Personnel in.....	TRS 4-3
Destruction:	
Emergency, (of) Records.....	MGT 1-2

Incineration.....SEC 3-3
 Loss or Unauthorized, of Records.....MGT 1-2
 Maceration.....SEC 3-3
 Detachment, Port.....TRS 6-5
 Detailing Employees.....CIV 6
 Development:
 Career:
 Civilian.....CIV 2
 Military.....MIL 3
 Devices, Photography Research on.....R&D 20-2
 Dietary (Services & Clinics).....MED 7-2
 Diffusion (Meteorology).....R&D 15-10
 Directives: (See also Publications)
 Procurement.....PRO 8-3
 Supply.....SUP 5-7
 Disbandment of Organizations.....MGT 8-5
 Discharge.....MIL 17-2
 Disciplinary Action.....CIV 4-1
 Discipline:
 Military.....MIL 5
 State of.....POL 1-13
 Disclosure, Security Information.....SEC 3-4
 Discontinuance of Organizations.....MGT 8-6
 Diseases.....MED 3-3
 Disinterments.....SUP 3-5
 Dispatch:
 Aircraft.....OPS 2-1
 Mail.....ADM 5
 Dispensary Administration.....MED 4
 Dispensing, Liquid and Fuel System.....INS 1-8
 Disposal:
 Property (Readjustment).....PRO 13-2
 Real Estate.....INS 4-2
 Records (of).....MGT 1-2
 Refuse (Facilities).....INS 1-10
 Disposition:
 Offenders Reports.....POL 1-4
 Personal Property.....SUP 2
 Schedules.....MGT 1-2
 Supplies.....SUP 2
 Dissemination of Intelligence Information.....INT 1
 Distribution:
 Charts and Maps.....MAP 5
 Fuels.....R&D 8-7
 Lubricants.....R&D 8-7
 Mail.....ADM 5
 Messages.....COM 1-2
 Postal.....MGT 9-2
 Projection Prints.....PHO 2-1
 Publications.....PUB 3-1
 Supplies.....SUP 1
 Tables of Manpower.....MGT 7-1
 Ditto Reproduction.....PUB 2
 Documentation.....MGT 1
 Historical.....MGT 4
 Photography.....PHO 6-3
 Documents:
 Intelligence.....INT 1-6
 Shipping.....SUP 4-1
 Domestic, Air Base (Use of).....OPS 1-1
 Dossiers, Target.....INT 4-4

Draft Deferment.....MIL 14-2
 Drivers, Qualification and Training.....TRS 5-3
 Dry Cleaning Service.....SUP 3-4
 Duty:
 Flying Status.....MIL 2-4
 Inactive:
 Separation.....MIL 17-3
 Training Pay.....MIL 8-7
 Release from.....MIL 2-7
 Temporary.....MIL 2-8
 Tours, Civilian.....CIV 9-1

E

Ecclesiastical Indorsing Agencies (Chaplains).....MIL 4-2
 Editorial Policy, Publications.....PUB 3-2
 Education:
 Dependents.....MIL 10-6
 Off-Duty.....MIL 10-6
 Religious.....MIL 4-7
 Research.....R&D 19-10
 Effectiveness:
 Air Crew (Health).....MED 3-1
 Evaluation (Performance).....MIL 9-3
 Electrical: (Research)
 Aircraft Accessories.....R&D 1-5
 Guided Missiles Equipment.....R&D 9-4
 Parts.....R&D 5-4
 Electricity: (Research)
 Atmospheric Physics.....R&D 22-4
 Physics.....R&D 21-2
 Electromagnetics:
 Electronics.....R&D 5-3
 Electronics:
 Collection and Dissemination.....INT 1-5
 Combat (System).....OPS 5-3
 Counter Measures.....R&D 5-1
 Instrumentation.....R&D 11-3
 Parts.....R&D 5-4
 Research.....R&D 5
 Systems Operations.....OPS 5
 Emergency Destruction of Records.....MGT 1-2
 Employees: (Civilian)
 Claims.....CIV 11-1
 Detailing.....CIV 6
 Fair Employment Practices.....CIV 7-2
 Food Service, for.....CIV 7-4
 Grievances.....CIV 7-3
 Groups.....CIV 7-1
 Housing.....CIV 7-4
 Indebtedness.....CIV 11-2
 Insurance.....CIV 7-5
 Relations.....CIV 7
 Transportation.....CIV 7-4
 Employment:
 Fair Practices.....CIV 7-2
 Overseas.....CIV 15-3
 Records.....CIV 8
 Enemy, Prisoners of War.....MIL 13-3

Engine (Research).....	R&D 6	Military.....	MIL 8-1
Accessories.....	R&D 6-1	Procurement.....	PRO 1-5
Instruments.....	R&D 6-2	Exit Control, Security.....	SEC 2-2
Engineering:		Expediting Production.....	PRO 9-3
Changes (Production).....	PRO 9-2	Expenditures.....	FIN 1-7
Human, Research in.....	R&D 19-3	Expense Accounting.....	FIN 6
Installation Planning.....	INS 3	Procedures.....	FIN 6-1
Materiel Maintenance.....	MTN	Records.....	FIN 6-2
Enlistment.....	MIL 14-1	Reporting.....	FIN 6-3
Bonus.....	MIL 8-5	Experimental Physics.....	R&D 21-3
Entertainment Services.....	MIL 10-7	Export Control of Supplies.....	SUP 5-3
Entomology.....	R&D 14-11		
Entry:			
Control.....	SEC 2-2		
Customs.....	TRS 3		
Environmental Sanitation.....	MED 6-2		
Epidemiology.....	R&D 14-12		
Equipment (Supply Class Numbers may be used as subdivisions) (Items of equipment listed under R&D may also be used as subdivisions to other major subjective categories).			
Building.....	INS 1-2		
Geographical.....	WEA 1-1		
Histories.....	MTN 3		
Monetary Accounting for.....	FIN 9-1		
Office.....	ADM 6		
Tables of.....	MGT 7-2		
Escort Service.....	SUP 3-5		
Estimates:			
Budget.....	FIN 4-3		
Call for.....	FIN 4-3		
Intelligence.....	INT 2		
Evacuation:			
Aeromedical.....	MED 1		
Forward.....	MED 1-1		
Intertheater.....	MED 1-2		
Intratheater.....	MED 1-3		
Operations.....	OPS 6-5		
Evaluation:			
Armament.....	R&D 2-3		
Effectiveness.....	MIL 9-3		
Personnel Utilization (Research on).....	R&D 19-2		
Events:			
Records of.....	POL 1-10		
Special.....	REL 3-2		
Examination:			
Food (Service).....	MED 8-2		
Physical.....	MED 5		
Civilian.....	CIV 15-4		
Military.....	MIL 14-1		
Examiners, Civil Service Board.....	CIV 15-2		
Exceptions, Information Disclosures.....	INT 3-1		
Excess Personal Property.....	SUP 2-1		
Exchange:			
Photographs, of.....	PHO 7-2		
Post.....	SUP 3-6		
Service Funds.....	FIN 10-1		
Execution, Contract Awards.....	PRO 3-3		
Exemption, Tax:			
Civilian.....	FIN 11		

F

Facilities:

Air Estimates.....	INT 2-1
Commercial (Radio and Wire).....	COM 4-1
Control Stations.....	COM 4-2
Fixed Radio.....	COM 4
Flight Check.....	COM 4-3
Industrial Resources.....	PRO 7-1
Installations.....	INS 1
School:	
Administrative.....	TNG 1
Flying.....	TNG 5
Professional.....	TNG 8
Special.....	TNG 9-4
Technical.....	TNG 9
Supply.....	SUP 5-8
Wire.....	COM 4
Facsimile, Communications, Research.....	R&D 4-4
Fair Employment Practices.....	CIV 7-2
Family Housing.....	INS 2
Favors.....	CIV 4-2
Federal:	
Budget.....	FIN 4-4
Supply Service.....	PRO 3-5
Ferrying of Aircraft.....	TRS 4-1
FHA Housing.....	INS 2-1
Field:	
Maintenance Cost Accounting.....	FIN 5-3
Medicine, Research.....	R&D 14-14
Personnel Records.....	MIL 7-2
Fighter:	
Flying:	
Schools.....	TNG 5-3
Training.....	TNG 5-3
Operations.....	OPS 6-6
Financial:	
Annual Plan.....	FIN 4-1
Management Administration.....	FIN
Financing, Contract.....	PRO 2
Fire:	
Control Systems, Research.....	R&D 2-8
Protection.....	INS 1-5
First Aid:	
School.....	TNG 4-3
Training.....	TNG 4-3
Fixed Radio Facilities.....	COM 4
Flags, Organizational.....	MGT 8-4

Flight:

- Aircraft Instruments Research on..... R&D 1-6
- Checks..... COM 4-3
- Operations..... OPS 6
- Equipment, Research..... R&D 1-7
- Techniques, Research..... R&D 1-7
- Orders..... PUB 1-3
- Regulations..... OPS 2-4
- Rules..... OPS 2-4
- ~~Safety..... OPS 2-5~~

Flying:

- Pay..... MIL 8-6
- Schools..... TNG 5
- Status..... MIL 2-4
- Training..... TNG 5

Folders:

- Air Objective..... MAP 2
- Official Personnel..... CIV 8-1

Food:

- Examination..... MED 8-2
- Services..... SUP 3-3
- Civilian..... CIV 7-4

Forecasting..... WEA 2-2

Foreign:

- Air Base (Use of)..... OPS 1-2
- Claims..... LEG 2-1
- Clearance Guides..... MAP 1-2

Nationals:

- Identification..... MIL 6-2
- Visits..... INT 1-8

- Procurement..... PRO 5
- Trainees..... TNG 6

- Formal Advertising (Contracts)..... PRO 3-4
- Format, Publications..... PUB 3-2

Forms Management MGT 11

- ~~Control..... PUB 3-1~~
- ~~Standardization..... PUB 3-3~~

- Forward Evacuation..... MED 1-1
- Freight, Commercial..... TRS 2-3
- Frequency Authorizations..... COM 4-4

Fuels..... R&D 8

- High Energy..... R&D 8-1
- Hydrocarbon..... R&D 8-4
- Rocket..... R&D 8-6

Fuses, Armament..... R&D 2-9

Functions, Administrative..... MGT 2

Funds:

- Allotment..... FIN 1-2
- Base Trust..... FIN 10-3
- Book Department..... FIN 10-1

Central:

- Base..... FIN 10-3
- Mess..... FIN 10-2
- Welfare..... FIN 10-3

- Chaplains..... FIN 10-2
- Civilian Welfare..... FIN 10-3
- Command Welfare..... FIN 10-3
- Exchange Service..... FIN 10-1
- Industrial..... FIN 12-1
- Management..... FIN 12-2
- Motion Picture Services..... FIN 10-1

- Nonappropriated..... FIN 10
- Open messes..... FIN 10-2
- Post Restaurants..... FIN 10-1
- Religious..... FIN 10-2
- Revenue Producing..... FIN 10-1
- Revolving..... FIN 12
- Stock..... FIN 12-3
- Sundry Association..... FIN 10-2
- Unit..... FIN 10-3
- Vocational Training..... FIN 10-1
- Welfare..... FIN 10-3
- Work Capital..... FIN 12-4
- Funerals, Military..... MIL 10-8

G

Gate Guarding..... POL 1-5

General:

- Courts-Martial..... LEG 1-3
- Inspection..... INV 4
- Ledger Accounting..... FIN 7
- Procedures..... FIN 7-1
- Records..... FIN 7-2
- Reporting..... FIN 7-3
- Medical and Health Status..... MED 3
- Orders..... PUB 1-4
- Purpose Motor Vehicles..... TRS 5-4

- Geodesy..... R&D 25-1
- Geodetic Data Sheets..... MAP 2-1
- Geology..... R&D 25-2

Geographical:

- Equipment..... WEA 1-1
- Requirements..... WEA 1
- Techniques..... WEA 1-1

- Geomagnetisms..... R&D 25-3
- Geophysical Aspects of Atomic Weapons..... R&D 25-4

Government:

- Furnished Materials..... PRO 6-2
- Property..... PRO 6

Graphic Presentation..... ADM 4

Gratuities:

- Civilian..... CIV 4-2
- Military..... MIL 8-3

- Grave Registration..... SUP 3-5
- Greases..... R&D 8-1
- Grievances..... CIV 7-3

Ground:

- Air, Rescue..... OPS 6-2
- Communication System..... R&D 4-5
- Reference, Navigation..... R&D 17-1

~~Safety..... MGT 3~~

- ~~Education..... MGT 3-1~~
- ~~Engineering..... MGT 3-2~~
- ~~Motor Vehicle Transportation..... MGT 3-3~~
- ~~Reports..... MGT 3-4~~
- ~~Research..... MGT 3-4~~
- ~~Training..... MGT 3-1~~

- Support Operations..... OPS 6-7
- Grounds..... INS 1-6
- Groups, Employees..... CIV 7-1

GSAP.....PHO 2-2
 Guaranteed Loans, Contracts.....PRO 2-2
 Guarding:
 Gate (Patrol).....POL 1-5
 Security.....SEC 2-2
 Guidance, Vehicle.....R&D 17-5
 Guided Missiles Research.....R&D 9
 Instrumentation.....R&D 11-4
 Guides, Foreign Clearance.....MAP 1-2
 Gun Sight Aiming Point Photography.....PHO 2-2
 Guns, Armament.....R&D 2-2

H

Handbook, Pilots.....MAP 1-4
 Handling:
 Aircraft.....R&D 1-11
 Equipment, Munitions.....R&D 2-11
 Military Information.....SEC 3-5
 Hardware, Machine.....R&D 7-3
 Headstones.....SUP 3-5
 Health:
 Dental Records.....MED 2-2
 Status.....MED 3
 High Energy Fuel.....R&D 8-2
 Historical:
 Documentation.....MGT 4
 Properties.....MGT 4-1
 Histories:
 Equipment.....MTN 3
 Unit.....MGT 4-3
 Honors for Dead.....SUP 3-5
 Hospital:
 Administration.....MED 4
 Capacity.....MED 4-1
 Status.....MED 4-1
 Hospitalization, Civilian.....CIV 7-5
 Hostilities, Indications of.....INT 2-5
 Hours of Work.....CIV 9
 Housing:
 Civilian.....CIV 7-4
 FHA.....INS 2-1
 Family.....INS 2
 Title VIII.....INS 2-2
 Human Engineering.....R&D 19-3
 Humanitarian Services (Chaplains).....MIL 4-3
 Hydraulic Fluids.....R&D 8-3
 Hydrocarbon Fuels.....R&D 8-4
 Hydrographic Charts.....MAP 7
 Hydrometers, Meteorology.....R&D 15-8

Identification:

Cards.....MIL 6-3
 Military Personnel.....MIL 6
 Photography.....PHO 1-2

Security.....SEC 2-2
 Tags.....MIL 6-6
 Illegal Use of Transport.....TRS 7
 Illustrations, Graphic.....ADM 4
 Immunization.....MED 6-3
 Immunology.....R&D 14-13
 Impedimenta, Military.....TRS 2-5
 Improvement, Management.....MGT 6
 Inactivation of Organizations.....MGT 8-7
 Inactive Duty:
 Separation.....MIL 17-3
 Training Pay.....MIL 8-7
 Incentive Program.....CIV 12
 Indebtedness.....CIV 11-2
 Indications of Hostilities.....INT 2-5
 Induction and Recall.....MIL 14-2
 Industrial:
 Audits.....FIN 2-3
 Funds.....FIN 12-1
 Processes, Research in.....R&D 10
 Property Control.....PRO 6-3
 Resources.....PRO 7
 Information:
 Disclosure Policy.....INT 3
 Internal.....REL 1-2
 Public.....REL 1-3
 Releases to Public.....REL 1-3
 Safeguarding Military.....SEC 3
 Services.....REL 1
 Inflight Refueling Operations.....OPS 6-9
 Initiation of Purchase and Procurement
 Authority.....PRO 8
 Injuries.....MED 3-4
 Inquiries, Congressional.....REL 3-1
 Inorganic Chemistry.....R&D 3-2
 Insect Control.....INS 1-7
 Insignias, Organizational.....MGT 8-4
 Inspection:
 Acceptance.....PRO 12-1
 Administrative.....INV 1
 General.....INV 4
 Special.....INV 6
 Visits.....INV 1
 Installations:
 Construction.....INS 1
 Facilities.....INS 1
 Maintenance.....INS 1
 Management.....INS
 Operation.....INS 1
 Instrument:
 Approach Charts.....MAP 13-1
 Flying:
 School.....TNG 5-4
 Training.....TNG 5-4
 Instrumentation.....R&D 11
 Instruments:
 Contractual.....PRO 4
 Engine.....R&D 6-2
 Guided Missiles.....R&D 9-5
 Navigation.....R&D 17-2

Insurance:	
Civilian.....	CIV 7-5
Travel.....	TRS 9
Integration of Commercial Air Facilities.....	TRS 4-2
Intelligence.....	INT
Annexes.....	INT 1-9
Counter.....	SEC 1
Photo.....	INT 1-12
Plans.....	INT 1-9
Operations Techniques.....	R&D 16-1
Reconnaissance.....	INT 1-14
School.....	TNG 9-1
Target.....	INT 4
Requirements.....	INT 4-3
Training.....	TNG 9-1
Intentions, Intelligence Estimates of Foreign.....	INT 2-6
Inter Agency, Cross Servicing	
Photo Agreements.....	PHO 1-1
Inter-theater Evacuation.....	MED 1-2
Interdepartmental:	
Accounting.....	FIN 1-8
Procurement.....	PRO 3-5
International:	
Accounting.....	FIN 8
Affairs.....	REL 2
Internment.....	SUP 3-5
Internal Audits.....	FIN 2-4
Internal Information.....	REL 1-2
Interpretations, Legal.....	LEG 4
Interrogation, Intelligence.....	INT 1-10
Interviews, Press.....	REL 1-3
Intra-theater Evacuation.....	MED 1-3
Intradepartmental Financial Transactions.....	FIN 1-8
Inventory, Supplies.....	SUP 4-1
Investigations.....	INV
Complaints.....	INV 2
Criminal.....	INV 3
Ionization, Atmospheric Physics.....	R&D 22-4
Items, Materiel (Supply Class Numbers may be used as Subdivisions under MTN and SUP)	

J

Jet Navigation Charts.....	MAP 13-7
Joint:	
Operations.....	OPS 7
War Plans.....	OPS 10-3
Jurisdiction:	
Command.....	MGT 2-3
Police.....	POL 1-1
Justice, Military.....	LEG 1
Justification, Budget Estimates.....	FIN 4-3

L

Labor, Industrial.....	PRO 7-2
Laboratory:	
Instrumentation.....	R&D 11-5

Service.....	MED 7-3
Launchers.....	R&D 2-12
Launching Equipment, Guided Missiles.....	R&D 9-6
Laundry Services.....	SUP 3-4
Law, Appropriation.....	FIN 4-1
Leadership, Research in.....	R&D 23-3
Leaves:	
Civilian.....	CIV 10
Military.....	MIL 1-3
Ledger:	
Allocation Accounts.....	FIN 1-2
Allotment Accounts.....	FIN 1-2
Cost.....	FIN 5
General.....	FIN 7-2
Legal:	
Administration.....	LEG
Assistance.....	LEG 3
Claims.....	LEG 2
Interpretations.....	LEG 4
Opinions.....	LEG 4
Schools.....	TNG 8-4
Training.....	TNG 8-4
Legislation, Proposed.....	REL 3-2
Legislative:	
Programs.....	REL 3-3
Relations.....	REL 3
Liaison:	
Armed Forces Special Weapons Project.....	OPS 3-1
Atomic Energy Commission.....	OPS 3-1
Civil Police.....	POL 1-2
Committee, Military.....	OPS 3-1
Public.....	REL 3-2
Libraries:	
Photographic Print, Aerial.....	PHO 1-4
Still Photography Print.....	PHO 5-1
Technical.....	MIL 10-9
Library:	
Operating Systems.....	MIL 10-9
Property.....	MIL 10-9
Services.....	MIL 10-9
Linguistics (Research).....	R&D 4-6
Liquid Fuel Storage.....	INS 1-8
Loans:	
Guaranteed Contract.....	PRO 2-2
Photographs, of.....	PHO 7-2
Logistics, War Plans.....	OPS 10-4
Long Range Navigation Charts.....	MAP 13-7
Loss:	
Damage, and (Freight).....	TRS 2-4
Military Information.....	SEC 3-6
Lost:	
Aircraft:	
Cargo.....	TRS 4-3
Personnel in.....	TRS 4-3
Loyalty:	
Citizens.....	INV 5-1
Contractors.....	INV 5-3
Employees.....	INV 5-2
Investigations.....	INV 5
Military Personnel.....	INV 5-4

Morale:	
Civilian.....	CIV 7-6
Military.....	MIL 10
Research.....	R&D 23-3
Morning Reports.....	MIL 11-1
Mortuary Services.....	SUP 3-5
Mosaics:	
Air Target.....	MAP 2-5
Special.....	MAP 12-3
Motion Picture:	
Funds.....	FIN 10-1
Photography.....	PHO 2
Production Project.....	PHO 2-3
Motor Vehicles Maintenance Cost	
Accounting.....	FIN 5-4
Movements:	
Bus.....	TRS 5-2
Materiel (Security).....	SEC 2-1
Orders.....	PUB 1-5
Special Authorization.....	TRS 5-6
Troop (Security).....	SEC 2-1
Unit.....	MGT 8-2
Moving.....	ADM 8-2
Munitions Handling Equipment.....	R&D 2-11
Music.....	MIL 10-3

N

Name, Change of.....	MIL 6-1
Nationals, Foreign:	
Accreditation.....	INT 1-8
Identification.....	MIL 6-2
Tours.....	INT 1-8
Visits.....	INT 1-8
NATO, Relations and Liaison with.....	REL 2-1
Navigation:	
Aids (Operations).....	OPS 8-1
Charts.....	MAP 13-7
Jet.....	MAP 13-7
Long Range.....	MAP 13-7
Flying:	
School.....	TNG 5-5
Training.....	TNG 5-5
Ground Reference Research.....	R&D 17-1
Instruments Research.....	R&D 17-2
Operations.....	OPS 8
Research.....	R&D 17
Negotiation of Contracts.....	PRO 3-6
Neurology Research.....	R&D 14-15
Neuropsychiatry Research.....	R&D 14-16
News Releases.....	REL 1-3
Nomenclature:	
Organizational.....	MGT 8-4
Photography.....	PHO 7-3
Supplies, for.....	SUP 5-1
Nonappropriated Funds.....	FIN 10
Non-Metallics Research.....	R&D 12-3
Non-Revenue Traffic.....	TRS 4-4
Notice of Shipment of Supplies.....	SUP 4-1

Notification of Casualties.....	MIL 10-5
Nuclear Structure Research.....	R&D 21-6
Nucleation, Atmospheric Research.....	R&D 22-2
Numbers, Serial (Identification).....	MIL 6-5
Nursing.....	MED 7-5

Obligations.....	FIN 1-9
Observations, Weather.....	WEA 3
Oceanographic Research.....	R&D 25-5
Offender Reports.....	POL 1-4
Offenses:	
Arrests and Complaints.....	POL 1-6
War Plans.....	OPS 10-5
Office:	
Equipment.....	ADM 6
Methods.....	MGT 6-1
Procedures.....	MGT 6-1
Supplies.....	ADM 6
Official Personnel Folders Civilian.....	CIV 8-1
Oils, Research.....	R&D 8-5
Open Messes, Funds.....	FIN 10-2
Operational Reports, Intelligence.....	INT 1-11
Operations:	
Analysis.....	OPS 9
Clandestine.....	OPS 4
Flight.....	OPS 6
Joint.....	OPS 7
Orders.....	PUB 1-6
Ophthalmology Research.....	R&D 14-17
Opinions, Legal.....	LEG 4
Optical, Instrumentation Research.....	R&D 11-6
Optics, Atmospheric Physics Research.....	R&D 22-6
Order of Battle, Air.....	INT 2-3
Orders:	
AF Reserve.....	PUB 1-1
Courts-Martial.....	PUB 1-2
Flight.....	PUB 1-3
General.....	PUB 1-4
Money.....	MGT 9-3
Movement.....	PUB 1-5
Operations.....	PUB 1-6
Personnel Action Memos.....	PUB 1-7
Special.....	PUB 1-8
Technical.....	PUB 1-9
Technical Compliance.....	MTN 9
Organization.....	MGT 8
Activation.....	MGT 8-1
Charts.....	MGT 2-2
Constitution of.....	MGT 8-3
Disbandment of.....	MGT 8-5
Discontinuance.....	MGT 8-6
Inactivation.....	MGT 8-7
Manpower, Tables of.....	MGT 7-2
Reorganization.....	MGT 8-8
Units, Assignment of.....	MGT 8-2
Organizational Analysis.....	MGT 6-2
Organic Chemistry Research.....	R&D 3-3

Orthopedics.....	R&D 14-18
Otorhinolaryngology.....	R&D 14-19
Overprints, Aeronautical.....	MAP 1-1
Overtime Pay.....	CIV 11-3
Overseas Employment.....	CIV 15-3

P

Packing:	
Records.....	MGT 1-2
Supplies.....	SUP 5-4
Panel, Reading.....	INT 1-13
Parachutes, Research.....	R&D 18
Parasitology Research.....	R&D 14-20
Partial Payments of Contracts.....	PRO 2-3
Passengers:	
Military Sea Transport, on.....	TRS 6-4
Transportation, Commercial.....	TRS 2-6
Passes, Security.....	SEC 2-2
Passports:	
Civilian.....	CIV 18-1
Military.....	MIL 6-4
Patents.....	LEG 5
Pathology Research.....	R&D 14-21
Patient Management.....	MED 4-3
Patrolling.....	POL 1-7
Security.....	SEC 2-2
Pavements.....	INS 1-1
Pay:	
Civilian.....	CIV 11
Accounting Operations.....	FIN 11
Overtime.....	CIV 11-3
Rates.....	CIV 11-4
Military.....	MIL 8
Allotments.....	MIL 8-1
Allowances.....	MIL 8
Payments:	
Advance:	
Appropriations.....	FIN 1-1
Contracts.....	PRO 2-3
Partial, Contracts.....	PRO 2-3
Payrolls, Civilian.....	FIN 11
Penalty, Mail.....	MGT 9-4
Per Diem, Travel:	
Civilian.....	CIV 18-2
Military.....	MIL 8-11
Performance:	
Civilian.....	CIV 12
Data on Materiel.....	MTN 6
Military.....	MIL 9
Ratings.....	CIV 12-3
Permanent Change of:	
Assignment.....	MIL 2-5
Station.....	MIL 2-6
Permits:	
Firearms.....	POL 1-8
Fishing.....	POL 1-8
Hunting.....	POL 1-8

Personal:	
Affairs.....	MIL 10-10
Counseling (Chaplains).....	MIL 4-4
Property:	
Disposition.....	SUP 2
Excess.....	SUP 2-1
Surplus.....	SUP 2-1
Personnel:	
Civilian.....	CIV
Accession.....	CIV 1
Action Memos.....	PUB 1-7
Appeals.....	CIV 12-3
Awards.....	CIV 12-1
Career Development.....	CIV 2
Compensation for Injury or Death.....	CIV 3
Conduct.....	CIV 4
Death and Burial.....	CIV 5
Demotion.....	CIV 14
Detailing.....	CIV 6
Duty, Tours of.....	CIV 9-1
Employee Relations.....	CIV 7
Employment Records.....	CIV 8
Examinations, Physical.....	CIV 15-4
Folders, Personnel.....	CIV 8-1
Grievances.....	CIV 7-3
Leave.....	CIV 10
Loyalty Investigations.....	INV 5-1
Passports.....	CIV 18-1
Pay Administration.....	CIV 11
Payroll Operations.....	FIN 11
Per Diem.....	CIV 18-2
Promotion.....	CIV 14
Qualifications.....	CIV 15-4
Ratings.....	CIV 12-3
Security Investigations.....	INV 5-1
Separation.....	CIV 17
Tax, Withholding.....	FIN 11
Travel.....	CIV 18
Claims.....	LEG 2-2
Military.....	MIL
Absence.....	MIL 1
Appointment.....	MIL 14-1
Assignment.....	MIL 2
Awards.....	MIL 9-2
Benefits.....	MIL 8-3
Burials.....	MIL 10-8
Career Development.....	MIL 3
Commendations.....	MIL 9-1
Conduct.....	MIL 5
Death.....	MIL 17-1
Decorations.....	MIL 9
Deferment.....	MIL 14-2
Demotion.....	MIL 15
Dependents Assistance.....	MIL 10-10
Desertion.....	MIL 1-2
Discharge.....	MIL 17-2
Education.....	MIL 10-6
Effectiveness Evaluation.....	MIL 9
Examinations, Physical.....	MIL 14-1
Flying Status.....	MIL 2-4
Funerals.....	MIL 10-8

Identification.....	MIL 6
Induction.....	MIL 14-2
Insurance.....	MIL 10-10
Marriage.....	MIL 10-10
Morning Reports.....	MIL 11-1
Passports.....	MIL 6-4
Pay and Allowances.....	MIL 8
Performance.....	MIL 9
Precedence.....	MIL 16
Procurement.....	MIL 14
Promotion.....	MIL 15
Rank.....	MIL 16
Reassignment.....	MIL 2
Recall.....	MIL 14-2
Records.....	MIL 7
Command.....	MIL 7-1
Field.....	MIL 7-2
Master.....	MIL 7-3
Retirement.....	MIL 17-4
Rosters.....	MIL 11-2
Separation.....	MIL 17
Serial Numbers.....	MIL 6-5
Statistics.....	MIL 11
Strength.....	MIL 11-3
Tags.....	MIL 6-6
Travel.....	MIL 8-11
Uniforms (Regulations concerning the wearing of).....	MIL 18
Visas.....	MIL 6-4
Voting.....	MIL 12-1
Pharmacology Research.....	R&D 14-22
Pharmacy Services.....	MED 7-6
Photo Intelligence.....	INT 1-12
Photography.....	PHO
Aerial Mapping and Charting.....	PHO 1
Agreements, Inter Agency.....	PHO 1-1
Motion Picture.....	PHO 2
Radar Scope.....	PHO 3
Research.....	R&D 20
Still.....	PHO 5
Photostat.....	PUB 2
Physical:	
Examinations.....	MED 5
Safeguards.....	SEC 2-2
Security.....	SEC 2
Communications Facilities.....	COM 2-2
Training.....	TNG 4-4
Physics: (Research)	
Atmospheric.....	R&D 22
General.....	R&D 21
Physiology Research.....	R&D 14-23
Pilot's Handbooks.....	MAP 1-4
Placement:	
Civilian.....	CIV 15
Contract.....	PRO 3
Planning:	
Installation:	
Construction.....	INS 3-1
Engineering.....	INS 3
Master.....	INS 3-3
Program.....	MGT 6-3
Plans:	
Intelligence.....	INT 1-9
War.....	OPS 10
Combined.....	OPS 10-1
Plant-in-Place Communications.....	COM 4-5
Plates, Aeronautical Video.....	MAP 12-1
Police Administration.....	POL 1
Policy:	
Color Photography.....	PHO 7-1
Editorial.....	PUB 3-2
Information Disclosure.....	INT 3
Political Activities:	
Civilian.....	CIV 4-3
Military.....	MIL 12
Port Detachments, MSTs.....	TRS 6-5
Position:	
Authorizations, Manpower.....	MGT 7-1
Classification.....	CIV 13
Series.....	CIV 13-1
Standards.....	CIV 13-1
Surveys.....	CIV 13-2
Post Exchange Operations.....	SUP 3-6
Post Offices (APO's).....	MGT 9-5
Post Restaurant Funds.....	FIN 10-1
Postage.....	MGT 9-6
Postal:	
Distribution.....	MGT 9-2
Equipment.....	MGT 9-7
Service.....	MGT 9
Power of Attorney.....	LEG 3-2
Practices:	
Conservation (Materials).....	MTN 1
Correspondence.....	MGT 1-1
Fair Employment.....	CIV 7-2
Preaching Missions.....	MIL 4-5
Precedence, Military.....	MIL 16
Prerogatives, Command.....	MGT 2-3
Presentations, Graphic.....	OFF 4
Press Interviews.....	REL 1-3
Preventive:	
Dentistry.....	MED 2-4
Maintenance.....	MTN 7
Medicine.....	MED 6
Research.....	R&D 14-24
Price Redetermination, Contracts.....	PRO 1-3
Print Libraries:	
Aerial Photography.....	PHO 1-4
Still Photography.....	PHO 5-1
Printing.....	PUB 2
Priorities:	
Materials.....	PRO 7-3
Travel Control.....	TRS 9
Prison Administration.....	POL 2-4
Prisoners:	
Casual.....	POL 2-1
Complaints of.....	POL 2-5
Individual Records.....	POL 2-6
Restoration to Duty.....	POL 2-7
Retraining.....	POL 2-8
War, of.....	MIL 13

Procedure:

- Appellate.....LEG 1-1
- Billing, MSTs.....TRS 6-1
- Office.....MGT 6-1
- Process, Photography Research.....R&D 20-2
- Procurement of Materials.....PRO
- Authority.....PRO 8
- Case Files.....PRO 11
- Directives.....PRO 8-3
- Foreign.....PRO 5
- Interdepartment.....PRO 3-5

Production:

- Aeronautical Charts.....MAP 9
- Control.....MGT 6-4
- Scheduling.....MGT 6-4

Professional:

- Clinics.....MED 7
- Schools.....TNG 8
- Services, Medical.....MED 7
- Training.....TNG 8

Program:

- Analysis.....MGT 6-3
- Budget.....FIN 4-1
- Planning.....MGT 6-3

Programming.....PRO 10

Programs:

- Incentive (Suggestions).....CIV 12-2
- Legislative.....REL 3-3

Projection Prints.....PHO 2-1

Promotion:

- Civilian.....CIV 14
- Military.....MIL 15

Property:

- Bailment.....PRO 6-1
- Confiscated.....POL 1-9
- Disposal (Readjustment).....PRO 13-2
- Government, for Industrial Use.....PRO 6
- Impounded.....POL 1-9
- Industrial Control.....PRO 6-3
- Library.....MIL 10-9
- Lost.....POL 1-9
- Monetary, Accounting of.....FIN 9

Personal:

- Disposition.....SUP 2
- Excess.....SUP 2-1
- Receipt for.....POL 1-9
- Recovered.....POL 1-9
- Stolen.....POL 1-9
- Surplus.....SUP 2-1

Propellants (Fuel), Research.....R&D 8-6

Propellers, Research.....R&D 1-10

Prosthetics.....MED 2-5

Protective Equipment.....R&D 7-2

Protection, Fire.....INS 1-5

Psychological Warfare:

- Operations.....OPS 10-5
- Research.....R&D 16-2

Psychology of Training.....R&D 19-7

Psychophysiology Research.....R&D 19-8

Public:

- Appearances.....REL 1-1

- Information.....REL 1-3
- Interest Campaigns.....ADM 3
- Publications.....PUB
- Aeronautical Information.....MAP 1
- Publishing.....PUB 3
- Purchase:
- Authority.....PRO 8
- Initiation.....PRO 8
- Request.....PRO 8-4

Qualifications:

- Driver.....TRS 5-3

Personnel:

Civilian:

- Educational.....CIV 15-4
- Experience.....CIV 15-4
- Physical.....CIV 15-4
- Training.....CIV 15-4

Military:

- Educational.....MIL 14-1
- Experience.....MIL 14-1
- Physical.....MIL 14-1
- Records.....MIL 3-2
- Training.....MIL 14-1

Quality Control.....PRO 12

Quartermaster Equipment Research.....R&D 7-8

Quarters, Allowances.....MIL 10-9

R

Radar:

- Airborne.....OPS 5-1
- Scope Photography.....PHO 3

Radiation Research, Atmospheric

- Physics.....R&D 22-7

Radio:

- Amateur.....COM 3-2
- Commercial.....COM 4-1
- Fixed Facilities.....COM 4
- MARS.....COM 3-2
- Releases (News).....REL 1-3
- Wire Facilities.....COM 4

Radiobiology Research.....R&D 14-25

Radiological Warfare Agents.....R&D 24-4

Radiology.....R&D 14-26

Railroads.....INS 1-9

Range, Instrumentation Research.....R&D 11-7

Rank, Military.....MIL 16

Rate, Pay:

- Civilian.....CIV 11-4
- Military.....MIL 8

Ratings, Performance.....CIV 12-3

Rationing Supplies.....SUP 5-2

Reading Panel.....INT 1-13

Readjustment Contracts.....PRO 13

Real Estate.....	INS 4	Services to Military.....	MIL 10-2
Monetary Accounting for.....	FIN 9-3	Refueling, Inflight.....	OPS 6-9
Reassignment, Military Personnel.....	MIL 2	Refuse:	
Recall to Duty.....	MIL 14-2	Collection.....	INS 1-10
Receipts:		Disposal.....	INS 1-10
Mail.....	ADM 5	Registration:	
Memorandum.....	SUP 4-1	Graves.....	SUP 3-5
Receivers, Communications.....	R&D 4-7	Vehicles.....	POL 1-15
Reconnaissance:		Regulations:	
Air Observation.....	WEA 3-1	Flight.....	OPS 2-4
Flying:		Publication of.....	PUB 3-2
School.....	TNG 5-6	Traffic (MATS).....	TRS 4-6
Training.....	TNG 5-6	Uniform Wearing.....	MIL 18
Intelligence.....	INT 1-14	Reimbursement:	
Operations.....	OPS 6-8	Appropriation.....	FIN 1-5
Recording:		Cost on Contracts.....	PRO 1-2
Communication Research.....	R&D 4-8	Relations:	
Sound.....	PHO 4	Civilian Employee.....	CIV 7
Records:		Intergroup and Inter-Personnel,	
Allotment.....	FIN 1-2	Research.....	R&D 23-2
Auditor's.....	FIN 2-2	Legislative.....	REL 3
Clinical.....	MED 4-2	Relay Centers (Communications).....	COM 1-3
Contractor's.....	PRO 1-1	Release from Duty.....	MIL 2-7
Current, Maintenance of.....	MGT 1-3	Releases:	
Dental Health.....	MED 2-2	Intelligence Information.....	INT 3-2
Disposal of.....	MGT 1-2	Public Information.....	REL 1-3
Disposition Schedules for.....	MGT 1-2	Reliability Data Sheets.....	MAP 2-3
Emergency Destruction of.....	MGT 1-2	Relief:	
Employment.....	CIV 8	Act:	
Events, of.....	POL 1-10	Civil.....	LEG 3-1
Expense Accounting.....	FIN 6-2	Soldiers and Sailors.....	MIL 10-10
General Ledger Accounting.....	FIN 7-2	Schedules.....	POL 1-11
Individual Prisoner's.....	POL 2-6	Religion.....	MIL 4-6
Loss and Unauthorized		Religious:	
Destruction of.....	MGT 1-2	Education.....	MIL 4-7
Machine (Statistical).....	MGT 10-1	Funds.....	FIN 10-2
Maintenance of.....	MGT 1-3	Renegotiation of Contracts.....	PRO 1-3
Microfilming of.....	MGT 1-4	Reorganization.....	MGT 8-8
Packing of.....	MGT 1-2	Repairs of Equipment.....	MTN 8
Personnel, Military.....	MIL 7	Reporting:	
Command.....	MIL 7-1	Casualty.....	MIL 10-5
Field.....	MIL 7-2	Expense Accounting.....	FIN 6-3
Master.....	MIL 7-3	General Ledger Accounting.....	FIN 7-3
Qualification (AF Form 11, etc.).....	MIL 3-2	Manpower, Research in.....	R&D 19-4
Retirement of.....	MGT 1-2	Reports:	
Schedules.....	MGT 1-2	Allotments.....	FIN 1-2
Shipping of.....	MGT 1-2	PM Activities.....	POL 1-12
Storage of.....	MGT 1-2	Control System.....	MGT 10-2
Transfer of.....	MGT 1-2	Monthly, MSTs.....	TRS 6-3
Recoupment of Funds.....	FIN 1-1	Morning.....	MIL 11-1
Recovery Equipment Research		Offenders, Disposition of.....	POL 1-4
(Guided Missiles).....	R&D 9-6	Operational.....	INT 1-11
Recreation:		Survey, of.....	FIN 16
Civilian.....	CIV 7-6	Unsatisfactory.....	MTN 10
Military.....	MIL 10-7	Representation, Carrier.....	TRS 2-2
Recruiting:		Reproduction:	
Civilian.....	CIV 15	Military Information.....	SEC 3-7
Military.....	MIL 14-3	Publication, of.....	PUB 2
Redetermination Contract Price.....	PRO 1-3	Requirements.....	PUB 2-1
Red Cross, American:		Requests, Purchase.....	PRO 8-4
Donations to.....	ADM 3		

S

Requirements:

Aeronautical Charts.....MAP 10
 Binding, Publication.....PUB 2-1
 Computation (Procurement).....PRO 10-1
 Ditto Printing.....PUB 2-1
 Geographical, Weather.....WEA 1
 Photostat.....PUB 2-1
 Printing.....PUB 2-1
 Reproduction.....PUB 2-1
 Supplies.....SUP 1-2
 Target Intelligence.....INT 4-3
 Requisitions, Supplies.....SUP 4-1

Rescue:

Air:
 Ground.....OPS 6-2
 Sea.....OPS 6-3
 Aircraft Crash.....INS 1-5
 Equipment, Research.....R&D 7-5

Research.....R&D
 Reserve Supplies.....SUP 5-6
 Resources, Industrial.....PRO 7
 Responsibilities, Administrative.....MGT 2

Restoration:

Civilians after Military Service.....CIV 16
 Prisoners, of.....POL 2-7

Retirement:

Deductions.....FIN 11
 Records, of Organizational.....MGT 1-2
 Military.....MIL 17-4

Retraining of Prisoners.....POL 2-8
 Retreats, Religious.....MIL 4-8

Revenue:

Producing Activities and Funds.....FIN 10-1
 Traffic, MATS.....TRS 4-5

Review:

Appellate.....LEG 1-1
 Budget Estimates.....FIN 4-3
 Publications.....PUB 4

Revolving Funds.....FIN 12
 Roads.....INS 1-11

Rockets: (Research)

Armament.....R&D 2-12
 Fuels.....R&D 8-6

Rodent Control.....INS 1-7
 Roentgenology Services.....MED 7-7

Rooms, Conference.....ADM 8-1
 Rosters, Military Personnel.....MIL 11-2

Rotary Wing:

Flying:
 Schools.....TNG 5-7
 Training.....TNG 5-7

Rotors, Aircraft.....R&D 1-10

Routes:

Air:
 Operation.....OPS 2-2
 Transportation.....TRS 2-7

Rules, Flight.....OPS 2-4

Safeguarding Military Information.....SEC 3
 Safety Programs.....INV 7
~~Ground~~.....~~MGT 3~~
~~Flight~~.....~~OPS 2-5~~

Sales:

Clothing.....SUP 3-1
 Excess Property.....SUP 2-1
 Photography.....PHO 7-2

Salvage and Surplus Materiel Accounting.....FIN 13
 Sanitation, Environmental.....MED 6-2

Savings Bonds:

Civilians.....FIN 11
 Military.....MIL 8-1

Schedules:

Delivery.....PRO 9-1
 Records Disposition.....MGT 1-2
 Relief.....POL 1-11

Schools:

Academic.....TNG 8-1
 Air Academy.....TNG 2
 Flying.....TNG 5
 Professional.....TNG 8
 Special.....TNG 9-4
 Technical.....TNG 9

Science, Terrestrial.....R&D 25
 Scope, Radar (Photography).....PHO 3

Sea:

Rescue, Air.....OPS 6-3
 Transport.....TRS 6

Security.....SEC

Communications.....COM 2
 Cryptographic.....COM 2-1
 Investigations.....INV 5
 Civilian Employees.....INV 5-1
 Contractors.....INV 5-3
 Employees.....INV 5-2
 Military Personnel.....INV 5-4
 Special Files.....INV 5-5
 Local Office.....OFF 5
 Physical.....SEC 2
 Communications Facilities.....COM 2-2
 Transmission.....COM 2-3

Seismology.....R&D 25-6

Selection:

Civilian.....CIV 15-5
 Personnel Utilization.....R&D 19-9
 Supplies.....SUP 5-5

Self Contained Navigation.....R&D 17-3

Serial Numbers.....MIL 6-5

Series, Position.....CIV 13-1

Services:

Bands.....MIL 10-3
 Base Veterinary.....MED 8-1
 Courier.....MGT 9
 Custodial.....INS 1-4
 Food (Civilian).....CIV 7-4
 Humanitarian.....MIL 4-3
 Information.....REL 1

Laboratory.....	MED 7-3	Schools.....	TNG 9-4
Library.....	MIL 10-9	Training.....	TNG 9-4
Medical.....	MED 7-4	Weapons: (Research)	
Messenger.....	ADM 5	Defense.....	R&D 24
Military Transport:		Effects.....	R&D 24
Air.....	TRS 4	Instrumentation.....	R&D 11-8
Sea.....	TRS 6	Specifications, Contracts.....	PRO 3-8
Music.....	MIL 10-3	Sports.....	MIL 8-11
Nursing.....	MED 7-5	Stability: (Research)	
Personnel.....	MIL 10	Aircraft.....	R&D 1-12
Pharmacy.....	MED 7-6	Guided Missiles.....	R&D 9-8
Postal.....	MGT 9	Standardization	
Professional (Medical).....	MED 7	Comms	PUB 3-3
Roentgenology.....	MED 7-7	Supplies.....	SUP 5-5
Supply.....	SUP 3	Standards:	
Surgical.....	MED 7-8	Performance.....	CIV 12-4
Telephone.....	COM 4	Position.....	CIV 13-1
Veterinary.....	MED 8	State of Discipline.....	POL 1-13
Servicing:		Statement of Charges.....	FIN 14
Aircraft, Research.....	R&D 1-11	Station, Permanent Change of.....	MIL 2-6
Agreements (Photography).....	PHO 1-1	Stations, Control (Radio).....	COM 4-2
Settlement, Readjustment.....	PRO 13-3	Statistical Data Repository.....	MGT 10-3
SHAPE.....	REL 2-2	Statistics.....	MGT 10
Shipping:		Personnel.....	MIL 11
Documents.....	SUP 4-1	Status, Hospital.....	MED 4-1
Records, Organizational		Stevedoring, MSTs.....	TRS 6-6
(Procedures for).....	MGT 1-2	Still Photography.....	PHO 5
Shipment, Notice of.....	SUP 4-1	Stock:	
Sights: (Research)		Control.....	SUP 4-1
Bomb.....	R&D 2-13	Funds.....	FIN 12-3
Gun.....	R&D 2-13	Level Control.....	SUP 4-1
Simulators, Equipment Research.....	R&D 7-7	Record Account.....	SUP 4-1
Site Surveys, Air Bases.....	OPS 1-3	Stockpiling:	
Society, Air Force Aid.....	MIL 10-1	Materials.....	PRO 7-3
Sociology.....	R&D 23	Supplies.....	SUP 5-6
Soil Mechanics Research.....	R&D 25-7	Storage:	
Solar Structure.....	R&D 22-3	Liquid Fuels (Facilities).....	INS 1-8
Solid State Physics Research.....	R&D 21-7	Military Security Information.....	SEC 3-8
Sound Recording.....	PHO 4	Records, of.....	MGT 1-2
Source Material, Maps and Charts.....	MAP 11	Research, Fuel.....	R&D 8-7
Sources, Contract Placement.....	PRO 3-7	Supplies, of.....	SUP 4
Space:		Strength, Personnel.....	MIL 11-3
Conference Rooms.....	ADM 8-1	Strikes, Transportation.....	TRS 2-8
Control.....	ADM 8	Structures (Facilities).....	INS 1-3
Moving.....	ADM 8-2	Subcontracting.....	PRO 1-4
Special:		Subversive Activities.....	SEC 1-1
Activities and Tenants, Appropriation		Subjection to Compromise of Security	
Accounting for.....	FIN 1-10	Information.....	SEC 3-6
Budget Estimates.....	FIN 4-3	Substance.....	MIL 8-10
Budgeting.....	FIN 4-1	Suggestions.....	CIV 12-2
Charts.....	MAP 12-2	Summary Courts-Martial.....	LEG 1-5
Courts-Martial.....	LEG 1-4	Sundry Association Funds.....	FIN 10-2
Dental Materials.....	MED 2-6	Supplemental Budget Estimates.....	FIN 4-3
Files:		Supplies	
Loyalty.....	INV 5-5	(Supply Class Numbers may be used as subdivisions.)	
Security.....	INV 5-5	(Items of equipment listed under R&D may also be	
Inspections.....	INV 6	used as subdivisions to other Major Subjective Cate-	
Missions.....	OPS 6-11	gories.)	
Movement Authorizations.....	TRS 5-7	Disposition.....	SUP 2
Orders.....	PUB 1-8	Distribution.....	SUP 1
Purpose (Motor Vehicles).....	TRS 5-7	Office.....	ADM 6

Storage of.....	SUP 4
Supply.....	SUP
Directives.....	SUP 5-7
Facilities.....	SUP 5-8
Requirements.....	SUP 1-2
System Management.....	SUP 5
Surety Bonds.....	FIN 15
Surface Weather Stations.....	WEA 3-2
Surgery Research.....	R&D 14-27
Surgical Services.....	MED 7-8
Surplus Personal Property.....	SUP 2-1
Survey, Report of.....	FIN 16
Surveys, Civilian Position.....	CIV 13-2
Survival Equipment Research.....	R&D 7-5
Switching.....	TRS 2-9
Synoptic Techniques Research.....	R&D 15-5
Systems:	
Communications.....	COM 3
Airborne.....	COM 3-1
Courier.....	MGT 6-1
Electronic.....	OPS 5
Fire Control Research.....	R&D 2-8
Library.....	MIL 10-9
Reports Control.....	MGT 10
Supply.....	SUP 5

T

Tables:	
Distribution, of.....	MGT 7-1
Organization & Equipment.....	MGT 7-2
Tactical:	
Flying:	
School.....	TNG 5-8
Training.....	TNG 5-8
Tags.....	MIL 6-6
Target:	
Analysis.....	INT 4-2
Charts.....	MAP 2-4
Dossiers.....	MAP 2
Intelligence.....	INT 4
Requirements.....	INT 4-3
Materials.....	INT 4-4
Air.....	MAP 2
Mosaics.....	MAP 2-5
Tax:	
Exemption (Contracts).....	PRO 1-5
Withholding	
Civilian.....	FIN 11
Military.....	MIL 8-1
Taxation.....	LEG 6
Technical:	
Assistance for Contractors.....	MTN 2
Compliance (Orders).....	MTN 9
Libraries.....	MIL 8-9
Orders.....	PUB 1-9
School.....	TNG 9
Training.....	TNG 9
Technicians, Industrial.....	PRO 7-2

Telemetering Research.....	R&D 4-9
Telephone Service.....	COM 4
Teletype:	
Communications.....	COM 4
Research.....	R&D 4-10
Television:	
Communication.....	R&D 4-11
Releases, News.....	REL 1-3
Temporary Duty.....	MIL 2-8
Terminal Control, Vehicle Research.....	R&D 17-4
Termination, of Contracts.....	PRO 13-4
Terminology, Photography.....	PHO 7-3
Terrain Models.....	MAP 12-4
Terrestrial Science Research.....	R&D 25
Tests:	
Aircraft.....	R&D 1-8
Atomic Warfare.....	OPS 3-3
Guided Missiles.....	R&D 9-9
Thermodynamics.....	R&D 21-8
Thunderstorms, Research.....	R&D 15-6
Thermo Nuclear Weapons.....	R&D 24-5
Title VIII Housing.....	INS 2-2
Titling, Photography.....	PHO 1-2
Tolls.....	TRS 5-8
Torpedoes (Research).....	R&D 2-10
Tort Claims.....	LEG 2-3
Tours of Duty, Civilian.....	CIV 9-1
Toxicology.....	R&D 14-28
Traffic:	
Control.....	POL 1-14
Air.....	OPS 2
Non-Revenue.....	TRS 4-4
Regulations, MATS.....	TRS 4-6
Revenue.....	TRS 4-5
Trainees, Foreign.....	TNG 6
Trainers.....	R&D 7-7
Training.....	TNG
Academic.....	TNG 8-1
Administrative.....	TNG 1
Aids.....	TNG 10
Facilities.....	INS 1-12
Aircraft Recognition.....	TNG 4-1
Basic:	
Flying.....	TNG 5-1
Nonflying.....	TNG 7-1
Chemical Warfare.....	TNG 4-2
Driver.....	TRS 5-3
First Aid.....	TNG 4-3
Flying.....	TNG 5
Foreign Trainees.....	TNG 6
Management.....	TNG 1-2
National Guard.....	TNG 3-2
Physical.....	TNG 4-4
Professional.....	TNG 8
Research.....	R&D 19-10
Reserve.....	TNG 3-1
Secretarial.....	TNG 1-3
Small Arms.....	TNG 4-5
Special.....	TNG 9-4
Technical.....	TNG 9
Unit.....	TNG 11

Transfer:	
Personnel (See Assignment, Reassignment, Detailing)	
Records, of.....	MGT 1-2
Transmission:	
Messages.....	COM 1-2
Military Security Information.....	SEC 3-5
Transmitters (Research).....	R&D 4-13
Transparencies.....	PHO 5-2
Transport:	
Illegal Use of.....	TRS 7
Military:	
Air Service.....	TRS 4
Sea.....	TRS 6
Operations (Flight).....	OPS 6-9
Transportation:	
Commercial.....	TRS 2
Freight.....	TRS 2-3
Passengers.....	TRS 2-6
Military:	
Air Transport.....	TRS 4
Non-Revenue.....	TRS 4-4
Cargo (Freight).....	TRS 4-4
Passengers.....	TRS 4-4
Revenue.....	TRS 4-5
Cargo (Freight).....	TRS 4-5
Passenger.....	TRS 4-5
Motor Vehicle.....	TRS 5
Sea Transport.....	TRS 6
Cargo (Freight).....	TRS 6-2
Passengers.....	TRS 6-4
Travel:	
Civilian.....	CIV 18
Control (Security).....	SEC 2-1
Insurance.....	TRS 8
Pay and Allowances:	
(Per Diem)	
Civilian.....	CIV 18-2
Military.....	MIL 8-11
Priorities.....	TRS 9
Treatment:	
Dental.....	MED 2-7
Medical.....	MED 7-4
Troop:	
Carrier Operations.....	OPS 6-10
Movement (Security).....	SEC 2-1
Trophies, Transportation.....	TRS 1
Turbulence Research.....	R&D 15-10

U

UCMJ ART 139 Claims.....	LEG 2-4
Unauthorized Destruction of Records.....	MGT 1-2
Uniforms (Regulations governing wearing of).....	MIL 18
Unit:	
Assignment of.....	MGT 8-2
Funds.....	FIN 10-3
Movements.....	MGT 8-2

Training.....	TNG 11
Unsatisfactory Reports.....	MTN 10
Utilities.....	INS 1-13
Utilization:	
Manpower.....	MGT 4-3
Supplies.....	SUP 5-5
Utility Boats.....	TRS 10

V

Vehicle:	
Motor.....	TRS 5
Operations.....	TRS 5-5
Registration.....	POL 1-15
Vermin Control.....	INS 1-7
Veterinary:	
Medicine Research.....	R&D 14-29
Service.....	MED 8
Virology Research.....	R&D 14-30
Visas:	
Civilian.....	CIV 18-1
Military.....	MIL 6-4
Visibility, Meteorology Research.....	R&D 15-7
Visitor Control (Security).....	SEC 2-2
Visits, Administrative.....	INV 1
Vocational Training Funds.....	FIN 10-1
Voting:	
Civilian.....	CIV 4-3
Military.....	MIL 12-1
Vouchers, Supply.....	SUP 4-1
Vulnerability.....	INT 4-1

W

Waivers.....	MIL 14-1
War, Prisoners of.....	MIL 13
War Plans.....	OPS 10
Combined (other countries).....	OPS 10-1
Defense.....	OPS 10-2
Joint (Army, Navy, Air Force).....	OPS 10-3
Warfare, Atomic.....	OPS 3
Warfare Agents Research	
Bacteriological.....	R&D 24-2
Biological.....	R&D 24-2
Chemical.....	R&D 24-3
Radiological.....	R&D 24-4
Warheads, Armament Research.....	R&D 2-14
Warehousing (also Open Storage).....	SUP 4-2
Water Research.....	R&D 15-8
Weapons, Thermonuclear Research.....	R&D 24-5
Weather:	
Forecasting.....	WEA 2-2
Research.....	R&D 15-9
Welfare:	
Civilian.....	CIV 7-6
Funds.....	FIN 10-3
Military.....	MIL 10
Wherry Housing.....	INS 2-2

Withheld Pay.....MIL 8-8
 Withholding Tax.....FIN 11
 Wills.....LEG 3-3
 Winds.....R&D 15-10
 Wire Facilities, Communications.....COM 4

Work:

Capital Funds.....FIN 12-4
 Hours of.....CIV 9
 Measurement.....MGT 6-4

Simplification.....MGT 6-4
 Worship.....MIL 4-9

X

X-Ray, Dental.....MED 2-3

Move to Alpha arrangement under Basic Filing Arrangements

Appendix B

RULES FOR ALPHABETICAL ARRANGEMENT

1. Sequence of Surnames

Names of individuals shall be arranged in alphabetical sequence, surname first, considering the alphabetical sequence of each letter of the surname in relation to the letters of other surnames with which it is filed:

- Able
- Adams
- Adamson
- Adler
- Allen

2. Identical Surnames

Identical surnames shall be arranged, first, by the first initial of the first given name, then the initial of the second given name, considering both initials, but disregarding the spelling of either the first or second given names except for the purpose of arranging names with identical initials:

- Allen, A
- Allen, Alice
- Allen, A. B.
- Allen, A. Bert
- Allen, B.
- Allen, Ben
- Allen, B. A.
- Allen, B. C.
- Allen, Ben D.
- Allen, B. John

3. Hyphenated Names

a. Hyphenated surnames of individuals shall be filed as one word:

- Page, D. A.
- Page-Lewis, S. M.
- Pagella, T. M.

b. If other than surnames of individuals, they shall be treated as separate words:

- Hall-Scott Motor Co.
- Halt Technical Laboratories

c. Names that are sometimes hyphenated and sometimes not, shall be filed as one word:

- Cooperative Market
- Co-operative Marketing Ass'n.
- Inter-State Canning Co.
- Interstate Shippers Ass'n.

4. Prepositions, Articles, and Conjunctions

Prepositions, articles, and conjunctions shall be disregarded in the arrangement of the name.

5. Abbreviations

File all abbreviations as though spelled in full:

- Assn Association
- Co Company
- Jas James
- Mt Mount
- Natl National
- St Saint

6. Names that Contain Numerals

Numerals that form part of a name shall be considered for filing as though spelled out:

- 19th Century Literary Club—Nineteenth Century Literary Club
- 10th Avenue Provision Co.—Tenth Avenue Provision Company

7. Names that Consist Entirely of Initials

Names that consist in part or entirely of initials (except when initials are part of an individual's name) shall be filed in front of all other names beginning with the same letter:

- OAX Radio Station
- OK Serum Company

Oaks, T. A.
 Ober, F. W.
 PDQ Messenger Service
 Parks, D. A.

8. Institutions and Schools

Institutions or colleges, as such, having as part of their names the name of an individual, shall be filed by the first letter of the individual's *given* or Christian name; companies and other business organizations excepted:

George Washington University
 Georgetown Hospital
 Johns Hopkins University
 Johnson, V. V.
 Theodore Roosevelt Hospital

9. Companies, Corporations, Other Business Firm Names

a. Companies, corporations, and other business firm names containing the name of an individual shall be filed by the first letter of the surname, after individuals of like name:

Smith, John E.
 Smith and Company
 Smith and Company, A. D.
 Smith Fish Company, C. R.

b. Identical business firm names shall be filed according to city and state in which they are located:

Brown and Company, Chicago, Illinois
 Brown and Company, San Francisco, California
 Smith and Sons, Springfield, Illinois
 Smith and Sons, Springfield, Massachusetts

10. Cities, Towns, Counties, States, Countries

Names of cities, towns, counties, states, and countries shall be filed after individuals, business firms, and institutions of like name:

Lyons, W. A.
 Lyons Warehouse Co.
 Lyons, Colorado—Board of Health
 Lyons County, Maryland—Police Department

11. Titles

Titles such as Captain, Doctor, Junior, Senior, Mrs, and so forth, shall be disregarded except where the names and initials

are identical, whereupon they shall be filed alphabetically by titles:

Jones, John F.
 Jones, John F. (Captain)
 Jones, John F. (Doctor)
 Jones, John F. (Jr)
 Jones, John F. (Mrs)

12. Prefixes

a. All names having a prefix as a part thereof shall be considered as one word whether the prefix is capitalized or not and shall be arranged in sequence with other names, considering the letters of the prefix in relation to the letters of other names:

Dalton
 D'Arcy
 Dawes
 De Armond
 Devon
 Van Burgund
 Van Courtland
 Van Dyke

b. Names having the prefixes M, Mc, and Mac shall be filed together in front of all names beginning with the letter "M," without regard to the spelling of the prefix:

McGinty, A. B.
 M'Ginty, B. A.
 Mac Ginty, C. D.
 M'Ginty, D. E.
 MacGinty, D. F.
 McGinty, F. G.

13. Estates

Estates shall be filed with companies:

Wilson & Co.
 Wilson & Co., T. E.
 Wilson, Estate, George C.
 Wilson Provision Co.
 Wilson & Young Co.

14. Words Denoting Direction

Names containing words denoting directions such as northwest, southeast, and so forth, sometimes written as one word and sometimes as two, shall be considered as one word when filed:

Southeast Producers Assn.
 South East Producers Assn.
 Westside Grocery
 West Side Meat Co.

15. Geographic or Location Words

Compound geographic or location words comprising a name are filed as separate words:

New Jersey Meat Co.
New York Packing Co.
Newark Provision Co.
West Virginia Grocery Co.
West Wellington Motor Corp.

16. Indexing the Alphabetical File

Indexing an alphabetical file of names is accomplished by the placement of guides indicating the various divisions and subdivisions of the alphabet under which each group of names fall. The number of alphabetical subdivisions used in a file depends

upon the number of names in the file, and whether the materials to be filed by name are individual papers, cards, case files, etc. As a general rule, an alphabetical subdivision guide should be provided for each 10 to 20 name folders, or for each 25 to 50 name cards. Standard sets of alphabetical subdivision guides are available from commercial sources in a wide variety of numbers of subdivisions. However, if such guides are procured it is recommended that "non-terminal" alphabetical subdivisions such as illustrated in the tables below, be specified. Use the number of guides that makes searching the file easiest, but remember that the use of too many guides will defeat their purpose.

Divisions of the Alphabet

15 Division		20 Division			60 Division						
A	M	A	J	Q	A	Co	Gi	Ki	Mu	Ro	U
B	N	B	K	R	Am	Cr	Gr	L	N	S	V
C	P	C	L	S	B	D	H	Le	O	Sch	W
D	R	D	Mc	T	Be	De	He	Li	P	Si	We
F	S	E	M	U	Bi	Do	Ho	Mo	Pe	St	Wi
H	T	F	N	V	Br	E	Hu	M	Pi	Su	XYZ
I	W	G	O	W	Bu	F	I	Mar	Q	T	
K		H	P	XYZ	C	Fi	J	Me	R	To	
		I			Ch	G	K	Mo	Ri		

100 Division

A	Bo	Cor	Et	H	J	McA	P	Se	Tr
Al	Br	Cr	F	Ham	John	M	Pe	Sh	U
Am	Bro	Cu	Fi	Har	K	Man	Pi	Si	V
Ander	Bu	D	Fo	Hat	Ke	Me	Pr	Smith	W
Ar	C	De	Fr	He	Ki	Mi	Q-R	Sp	War
B	Car	Di	G	Hi	Kn	Mo	Ri	St	We
Bar	Ch	Do	Ge	Ho	L	Mu	Ro	Sto	Wh
Be	Cl	Dow	Go	Hon	Le	N	Ros	T	Wi
Ber	Co	E	Gr	Hu	Li	Ni	S	Tho	Wo
Bi	Con	El	Gro	I	Lo	O	Sch	Ti	XYZ

150 Division

A	Br	Cu	Fl	Har	Jones	McD	P	Se	V
Al	Bro	D	Fo	Harr	K	McK	Pe	Ch	Ve
Am	Bu	Davis	Fr	Hat	Ke	M	Pet	Si	W
Ander	C	De	Fri	He	Kel	Man	Pi	Smith	Wall
Ar	Car	Del	G	Hen	Kl	Mas	Pr	Sn	War
At	Cas	Di	Gar	Her	Kn	Me	Pu	Sp	We
B	Ch	Do	Ge	Hi	Kr	Mi	Q-R	St	Wei
Baker	Che	Dow	Gi	Ho	L	Miller	Re	Sto	Wh
Bar	Cl	Du	Go	Hol	Lar	Mo	Ri	Su	Wi
Be	Co	E	Gr	Hon	Le	Mor	Ro	T	Williams
Ber	Con	El	Gre	Hu	Lei	Mu	Ros	Te	Wilson
Bi	Coo	Et	Gro	Hun	Li	N	Ru	Tho	Wo
Bl	Cor	F	H	I	Lo	Ni	S	Ti	Wr
Bo	Cr	Fe	Hal	J	Lu	O	Sch	Tr	XY
Bon		Fi	Ham	John	McA	Or	Schm	U	Z

RECORDS MANAGEMENT**Maintenance of Current Records**

AFM 181-4, 20 February 1958, is changed as follows:

1. Make the following changes by pen and ink:

<i>Page</i>	<i>Paragraph</i>	<i>Action to be taken</i>
v		Change heading "Paragraph" to read "Figure".
7		In figure 6, change folder labeled "ANDR" to read "AN"
33		Align "CIV 17. Separation" and "CIV 18 Travel" as primary subdivisions.
33		Align "FIN 1-5 Reporting Instructions and Requirements" as a secondary subdivision.
38		Add new primary subdivision "11 Forms Management" to major subjective category "ADMINISTRATIVE MANAGEMENT—MGT".
41		Delete the subdivision "3-3 Forms Standardization and Control".
49		Change the symbol for Accident, Ground Safety "MIL 3" to read "MGT 3".
54		Delete the entry "Forms PUB 3-3" appearing under "Control".
57		Substitute "Forms Management MGT 11" for the entries "Forms: Control PUB 3-3" and "Forms: Standardization PUB 3-3".
67		Delete the entry "Forms PUB 3-3" appearing under "Standardization".

2. Change references on pages 30, 32, 33, and 56 to the major subjective category "FINANCIAL MANAGEMENT" to read "FINANCIAL ADMINISTRATION". The symbol for this category remains "FIN".

3. The symbol ★ is used to indicate new or revised material in the text.

4. **The attached pages have been filed accordingly.**

5. After taking the necessary action, file this cover sheet in front of the manual.

BY ORDER OF THE SECRETARY OF THE AIR FORCE:

OFFICIAL:

THOMAS D. WHITE
Chief of Staff

J. L. TARR
Colonel, USAF
Director of Administrative Services

Attachments:

Pages 23-24

DISTRIBUTION:

F; X:

Air Force Records Center, 9700 Page Blvd, St. Louis 14, Mo.....	25
Federal Records Center, GSA, King and Union Streets, Alexandria, Va.....	10

Records Management

MAINTENANCE OF CURRENT RECORDS

AFM 181-4, 20 February 1958 is changed as follows:

1. Make the following changes by pen and ink:

Page	Paragraph	Line(s)	Action To Be Taken
4	6		Change "(1), (2), (3), (4), (5), (6)," to "a, b, c, d, e, f."
7	13	5 & 6	Delete "Records Management Group."
8	Title	2	Change "Records" to "Correspondence."
13	Figure 8		Change date to "1 Jun 61."
14	16d	1	Change "they" to "it." Add "s" to "concern."
46	Appendix A		Under "SUPPLY & SERVICES—SUP," change as follows: 1-1 Basis of Issue Accountability Equipment Authorization Allowance Documents Foreign Government Loan, Donation and Exchanges Rations

This change supersedes Interim Changes: 1, 25 November 1960; and 2, 25 May 1961.

DISTRIBUTION:

F; X:

(AF) Branch Military Personnel Records Center, 9700 Page
Bld., St. Louis Mo. 63132 25
Federal Records Center, GSA, King & Union Streets, Alex-
andria, Va. 10

2. The ★ is used throughout the manual to indicate new or revised material in the text.
3. The following pages have been filed accordingly.

REMOVE		INSERT
Page	Edition Date	Page
1, 2	20 Feb 58	1, 2
9 thru 12	20 Feb 58	9 thru 12
15, 16	20 Feb 58	15 thru 20.5
17, 18	6 Oct 58	
19, 20	20 Feb 58	
25, 26	20 Feb 58	25, 26

4. After taking the necessary action, file this change sheet in the front of the manual.

BY ORDER OF THE SECRETARY OF THE AIR FORCE:

OFFICIAL:

CURTIS E. LeMAY
Chief of Staff

R. J. PUGH
Colonel, USAF
Director of Administrative Services

Records Management

MAINTENANCE OF CURRENT RECORDS

AFM 181-4, 20 February 1958, is changed as follows:

1. Pen and Ink Changes:

Page	Paragraph	Line	Action To Take
iii	Chapter 3	1	Delete "RECORDS" and substitute "CORRESPONDENCE."
3	4c	4, 5	Change to read ". . . will preclude their combination with standard-size records."
7	12	9-19	Delete "However, . . . project was completed."
7	13	7	Substitute "(AFDASB)" for "(AFCAS-8)."
10	15g(4)(a)	4-6	Insert a period after "reference" and delete "or to segregate . . . different retention periods."
11	15g(6)	1	Substitute "Original" for "A copy."
		2-3	Delete "including superseded plans."
		4	Delete " <i>general correspondence.</i> "
		9-13	Delete "(Note . . . system)."
14	16b	3	Delete "the offices served by."
14	16c	3	Delete "the offices served by."
20.1	19g	.	Delete this paragraph, including subparagraphs (1), (2), (3), and (4).
20.1	20	4-5	Delete "distinction and."
21	26	2-5	Change second sentence to read "See AFR 205-1 and the implementing security directives before labeling cabinets containing classified material."
25	32c	2	Substitute "1 $\frac{1}{8}$ " for " $\frac{1}{8}$."
26	34b	3	Substitute "AF Form 80" for "records control schedule."

<i>Page</i>	<i>Paragraph</i>	<i>Line</i>	<i>Action To Take</i>
35	INV		Add as primary subdivision: "7 Safety Programs."
38	MGT		Delete primary and further subdivisions of "3 Ground Safety."
39	OPS		Delete secondary and further subdivisions of "2-5 Flight Safety."
57	Flight		Delete "Safety OPS 2-5."
57	Ground		Delete "Safety MGT 3" and all subdivisions.
66	Safety		Delete present subdivisions and substitute "Safety Programs INV 7."

2. Page Changes. Remove pages 15 through 20, dated 30 August 1961, and insert the attached revised pages.

3. New or Revised Material. This is indicated by a ★.

4. Filing. After taking necessary action, file this cover sheet in back of the manual.

BY ORDER OF THE SECRETARY OF THE AIR FORCE

OFFICIAL

CURTIS E. LeMAY
Chief of Staff

R. J. PUGH
Colonel, USAF
Director of Administrative Services

IMMEDIATE ACTION

CHANGE

AFM 181-4D

**AIR FORCE MANUAL
NO. 181-4D**

✓ **DEPARTMENT OF THE AIR FORCE**
Washington, 14 May 1965

Records Management

MAINTENANCE OF CURRENT RECORDS

AFM 181-4, 20 February 1958, is further changed as follows:

1. Remove pages 25 and 26, 30 August 1961, and insert the attached revised pages.
2. New or revised material is indicated by ★.
3. After making above changes, file this change sheet in back of the manual.

BY ORDER OF THE SECRETARY OF THE AIR FORCE

OFFICIAL

J. P. McCONNELL
General, U.S. Air Force
Chief of Staff

R. J. PUGH
Colonel, USAF
Director of Administrative Services

DISTRIBUTION: F; X:

MPRC (AF) 9700 Page Blvd, St. Louis, Mo. 63132	25
Federal Records Center, GSA, King & Union St., Alexandria, Va 22314	10

IMMEDIATE ACTION

AFL 181-4

DEPARTMENT OF THE AIR FORCE
WASHINGTON DC 20330

AIR FORCE LETTER
NO. 181-4

11 March 1965

SUBJECT: Conservation of Equipment and Space Occupied by Records

TO: (Distribution: S)

Expires 31 August 1966 unless sooner rescinded or superseded.

1. Purpose. This letter implements a Presidential directive and General Services Administration (GSA) regulation, imposing on all Federal agencies, a moratorium on the purchase of filing cabinets. It applies to all activities Air Force-wide.

2. Background. The President's moratorium is intended to attain the more effective use of office space and equipment used for maintaining records through procedures which will insure the prompt retirement or destruction of records no longer required for conducting current business. To this end, prerequisite actions are required as justification for the procurement of filing cabinets.

3. Security Filing Cabinets. While the President's moratorium does not apply to GSA tested and approved security filing cabinets required for the safeguarding of classified information by AFR 205-1, the requirements of paragraphs 4 and 5 apply to requisitions for such equipment.

4. Action Required:

a. Commanders will require that all requisitions for letter- and legal-size filing cabinets be reviewed by a records officer (appointed in accordance with AFR 181-1) to insure that the office requesting the filing cabinets has taken the following actions:

(1) All records are identified on AF Forms 80, "Files Maintenance and Disposition Plan," and 82, "Files Disposition Control Label," and maintained in accordance with AFM 181-4.

(2) All temporary records eligible for destruction in accordance with disposal criteria in AFM 181-5 have been destroyed.

(3) All noncurrent records not eligible for destruction have been retired to the records staging area or records center in accordance with the instructions on AF Forms 80 and 82.

(4) Filing cabinets are being fully used for current records, including top and bottom drawers.

(5) The contents of filing cabinets have been re-housed in more economical equipment such as shelf files in accordance with guidelines prescribed by chapter 5, AFM 181-4.

This letter supersedes AFL 181-4, 5 February 1965.

OPR: AFDASB

(6) All security filing cabinets not being used for classified material have been exchanged for nonsecurity type of filing cabinets.

b. If the office requesting the filing cabinet has complied with all of the prerequisites prescribed in a above and the additional filing cabinet is needed, the records officer will so certify on the requisition. He will then forward the requisition to the supply activity for necessary action.

5. Collateral Policies and Actions:

a. Requests for filing cabinets normally will be limited to essential requirements arising from new or materially expanded offices.

b. Filing ^{supply & equipment} cabinets will not be requested solely for the purpose of improvement in appearance, office decor, status elevation, or desire for the latest design or more expensive types.

c. The requisition and use of power files or other unconventional filing equipment solely as a basis for circumventing this moratorium is prohibited.

~~d. All filing cabinets turned-in as a result of actions required by paragraph 4 and the office space released by such actions will be reported as cost reduction items according to AFM 400-12 if they meet the applicable criteria. See section 3, chapter 3, AFM 181-5, 1 July 1963, as amended, for calculation guidelines.~~

BY ORDER OF THE SECRETARY OF THE AIR FORCE



R. J. PUGH

Colonel, USAF

Director of Administrative Services

Records Management

MAINTENANCE OF CURRENT RECORDS

AFM 181-4, 20 February 1958, is changed as follows:

1. Pen and Ink Changes:

Page	Paragraph	Line	Action To Take
iii	Chapter 3	1	Delete "RECORDS" and substitute "CORRESPONDENCE."
3	4c	4, 5	Change to read ". . . will preclude their combination with standard-size records."
7	12	9-19	Delete "However, . . . project was completed."
7	13	7	Substitute "(AFDASB)" for "(AFCAS-8)."
10	15g(4) (a)	4-6	Insert a period after "reference" and delete "or to segregate . . . different retention periods."
11	15g(6)	1	Substitute "Original" for "A copy."
		2-3	Delete "including superseded plans."
		4	Delete "general correspondence."
		9-13	Delete "(Note . . . system)."
14	16b	3	Delete "the offices served by."
14	16c	3	Delete "the offices served by."
20.1	19g		Delete this paragraph, including subparagraphs (1), (2), (3), and (4).
20.1	20	4-5	Delete "distinction and."
21	26	2-5	Change second sentence to read "See AFR 205-1 and the implementing security directives before labeling cabinets containing classified material."
25	32c	2	Substitute "1 $\frac{1}{8}$ " for "1 $\frac{1}{8}$."
26	34b	3	Substitute "AF Form 80" for "records control schedule."

<i>Page</i>	<i>Paragraph</i>	<i>Line</i>	<i>Action To Take</i>
35	INV		Add as primary subdivision: "7 Safety Programs."
38	MGT		Delete primary and further subdivisions of "3 Ground Safety."
39	OPS		Delete secondary and further subdivisions of "2-5 Flight Safety."
57	Flight		Delete "Safety OPS 2-5."
57	Ground		Delete "Safety MGT 3" and all subdivisions.
66	Safety		Delete present subdivisions and substitute "Safety Programs INV 7."

2. Page Changes. Remove pages 15 through 20, dated 30 August 1961, and insert the attached revised pages.

3. New or Revised Material. This is indicated by a ★.

4. Filing. After taking necessary action, file this cover sheet in back of the manual.

BY ORDER OF THE SECRETARY OF THE AIR FORCE

OFFICIAL

CURTIS E. LeMAY
Chief of Staff

R. J. PUGH
Colonel, USAF
Director of Administrative Services

activities, conducting a large volume of correspondence with the general public, the Congress, or other government agencies, may find a "name index" useful in quickly locating correspondence filed by subject. When such an index is warranted, it will be maintained in front of the first drawer of the files to which it relates.

c. *Continuity Cross-Referencing.* This is the use of a cross-reference sheet describing a document brought forward from one folder to another and consolidated with related papers. The continuity cross-reference sheet is filed, replacing the document brought forward.

For example: a basic letter with 2 indorsements, filed under date of 21 Jun 60, may be brought forward and attached to another basic letter, dated 7 Jan 61, on the same subject and transaction. A cross-reference sheet is prepared and filed in place of the letter dated 21 Jun 60 to show that the letter has been placed in the files of the following year.

d. *Cross-Reference Designation.* File and cross-reference designations will be placed on the document as illustrated in figure 7. A check mark, drawn through the (x), will indicate that the cross-reference has been prepared. Names to be cross-referenced should be underlined. Place an (x) over the name after cross-reference has been made.

★e. *Preparation of Cross-Reference Sheets.* DD Form 334 (supplied in single sheets is used for this purpose (see figure 8).

(1) *Date.* Type date of correspondence or document being cross-referenced: day, month, and year (e.g., 1 June 1961). If no date is shown, insert "ND" and approximate date, or, date received.

(2) *Index.* List all subject and name cross-references which the classifier has

marked. If more than one reference is required, use additional DD Forms 334 as needed. This form is also used for "continuity cross-referencing."

(3) *To.* Enter name of individual or organization to whom the document is addressed.

(4) *From.* Indicate document originator.

(5) *Summary.* Enter subject line of document being cross-referenced. If further identification is needed, include names, serial numbers, sums of money, or other supplementary information.

(6) *Filed.* Enter file designation of the document. When a continuity cross-reference sheet is being prepared, place the new date (under which the correspondence will be filed) in parentheses after the file designation; e.g., MGT 1-1 (1 Jan 63).

★f. *Substitution of Copies for DD Form 334.* If an extra copy of the document to be cross-referenced is available, use it instead of DD Form 334. Also, use copies made on "fast copy" machines in lieu of DD Form 334 when facilities are conveniently located.

(1) *When Extra Copies Are Used.* Mark extra copy as illustrated in figure 7. Circle file designation to indicate where the extra copy is to be filed as a cross-reference.

(2) *When Fast Copies Are Used.* Mark the record copy (as illustrated in figure 7) before making fast copies of it. Circle file designation, on the copy, to indicate where it will be filed as a cross-reference.

(3) *Continuity Cross-Reference.* When using extra or fast copies for continuity cross-reference, write (in parentheses) the new date under which the document is filed (as described in subparagraph e(6) above).

Chapter 4

FILES PROCEDURES

18. What This Chapter Contains

This chapter contains instructions for:

- a. Filing to facilitate disposition of records.
- b. Maintaining classified records.
- c. Preparing and assembling correspondence for file.
- d. Using guides and folders.
- e. Labeling guides, folders, and cabinets.
- f. Charging out documents from the file.
- g. Fastening papers.
- h. Sorting records.
- i. Cutting off files after prescribed periods of time or upon occurrence of a specific event.

19. Adaptation of Filing Procedures To Facilitate Disposition of Records

★a. *General Policy.* Planning for records maintenance has 2 objectives:

- (1) To arrange records to meet current reference requirements.
- (2) To identify and group series of records to facilitate systematic disposition authorized by AFM 181-5.

Arrange files to make it easier to destroy or retire them. *For example:* arrange files to permit periodic retirement or disposal of each records series in complete blocks (see figure 10). Do not interfile records having different retention periods.

★b. *Consolidated Files Maintenance and Disposition System.* AF Forms 80 and 82,

"Files Maintenance and Disposition Plan," and "Files Disposition Control Label," are the 2 basic elements of this system. These forms (described in c and d below) replace AF Forms 296 and 296a, "Records Control Schedules," and "Continuation Sheet," and the general correspondence files outline. Records control schedules, superseded by this system, will be retained as long as needed.

c. *Files Maintenance and Disposition Plan:*

(1) *Purpose.* AF Form 80, "Files Maintenance and Disposition Plan," will be prepared by each office of record (see figure 10a). It identifies all records for which an office has responsibility—both general correspondence files and other separate series of records. When used with labels (described in d below), this form provides a comprehensive and efficient system for maintaining and disposing of records.

(2) *Preparation.* Both sides of AF Form 80 will be used and prepared (in duplicate) as follows:

(a) *Column 5A.* Start with number 1 and consecutively number each series of records on the "Plan."

(b) *Column 5B.* Enter a brief, precise description of each series of records, using title of the applicable paragraph of AFM 181-5. If necessary for series identification, list various documents in the series. Occasionally, the local title of a series differs from AFM 181-5. In such instances, add the local title immediately after title used in the manual. (*NOTE:* If a group of records is not identified in AFM 181-5, use a brief title that is descriptive of the file and its function.) When identifying general correspondence files, list the "mis-

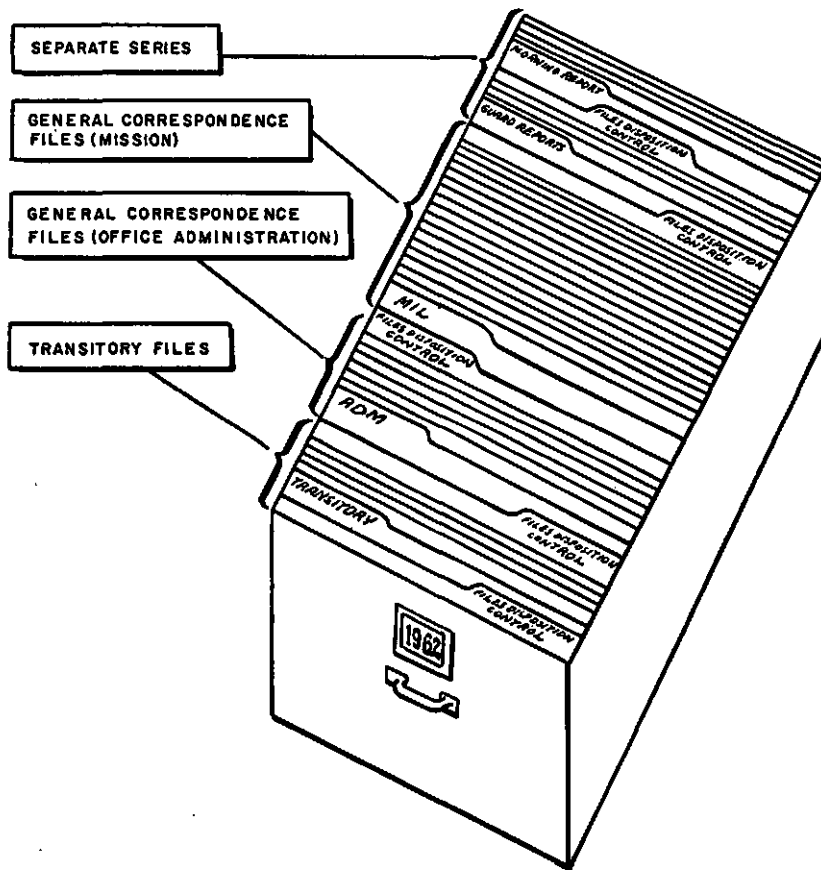

Figure 10. File Drawer Illustrating Placement of AF Forms 82

FILES MAINTENANCE AND DISPOSITION PLAN		DATE PREPARED 1 August 1963	
1. OFFICE SYMBOL OF OFFICE OF RECORD OR UNIT DESIGNATION Office of Safety		2. PREPARED BY (Name of records clerk) John Jones	
3. TYPED NAME AND POSITION TITLE OF RECORDS CUSTODIAN Richard Roe Assistant Director of Safety		4. SIGNATURE OF CUSTODIAN	
5. FILES PLAN			
ITEM NO.	TITLE OR DESCRIPTION OF RECORDS SERIES	FILED ARRANGEMENT OF EACH SERIES (Subjective, numerically, alphabetically, etc.)	DISPOSITION (Insert number of paragraph and sub-paragraph in AFM 181-4C. If paragraph cannot be found, enter "None.")
1	FILES MAINTENANCE AND DISPOSITION PLAN (AF FORM 80)	Front of Files	160303a
2	ROUTINE TRANSITORY RECORDS	Chronological	050102
3	GENERAL CORRESPONDENCE FILES (Office Admin) ADM OFFICE ADMINISTRATION 1 Administration of Office Personnel 2 Budgeting	Subjective	050101a(2)
4	GENERAL CORRESPONDENCE FILES (Mission) INV INVESTIGATIONS AND INSPECTIONS 1 Safety Programs 1-1 Flight Safety 1-2 Ground Safety	Subjective	050101a(1)
5	GROUND ACCIDENT SUMMARIES	Chronological	120310
6	GROUND ACCIDENT REPORTS	Chronological	120312
7	AIRCRAFT ACCIDENT AND/OR INCIDENT REPORTS	Alphabetical	120311

AF FORM 80
Aug 61

Figure 10a. Files Maintenance and Disposition Plan (Policy Making Office).

sion" and "office administration" portions of the file as separate items (see figure 10a). Then list specific subjects making up each portion of the file (see paragraph 15g and figure 10a). On the form, list records series in the sequence that best suits the needs of the using office.

(c) *Column 5C.* Self-explanatory.

(d) *Column 5D.* Enter paragraph and subparagraph numbers of AFM 181-5 prescribing disposition of the records. If a paragraph covering disposition of the files cannot be found, enter "None," and advise the records officer.

(3) *Distribution.* AF Form 80 original will be retained by the office of record. Forward the copy to the responsible records officer for review and use in monitoring maintenance and disposition of records concerned.

(4) *Review.* Preparation of AF Form 80 is a one-time job. However, periodically review and amend the form to insure that all files are accounted for and that cited disposition authorities are appropriate. Records officers will be notified of any corrections, deletions, or additions. Reaccomplish AF Form 80 only when further corrections or additions cannot be made.

★(5) *Standardization of AF Form 80.* Some lower echelon activities (such as base exchange units) accumulate, maintain, and dispose of like records in the same way. In such cases, standardization of AF Form 80 will save time and money. Proposed standard AF Form 80 will be approved by the command records management officer before using activities prepare and distribute them.

d. *Files Disposition Control:*

★(1) *Purpose.* AF Form 82, "Files Disposition Control Label" (see figure 10b), is printed on special paper stock which adheres to file guide cards when moistened with water. Affix this form to tabs of guide cards preceding *each* record series to facilitate block disposition of records. This identifies records filed behind each guide card and prescribes their ultimate disposition (in accordance with authorities from AFM

<small>GPO : 1961 OF-610244</small>	
1. TITLE OR DESCRIPTION OF RECORDS SERIES	
3. GENERAL CORRESPONDENCE FILES (Office Admin- istration)	
2. PARAGRAPH NO. FROM AFM 181-5 050101a(2)	
3. CUT-OFF INSTRUCTIONS 31 December	
4. DISPOSITION INSTRUCTIONS Destroy after 1 year.	
FILES DISPOSITION CONTROL LABEL	
AF FORM Aug 61 82	REPLACES AF FORMS 296, JAN 57 AND 296A, JUL 54 WHICH MAY BE USED UNTIL 1 JAN 63.

Figure 10b. Files Disposition Control Label.

181-5 cited on the related AF Form 80). These guide cards and labels are "disposition guide cards," as distinguished from "locator guide cards" described in paragraph 25. Do not use both "locator" and "disposition" guide cards in front of a records series because the disposition guide card also serves as a locator guide card.

★(2) *Use:*

(a) *Placement of Disposition Guide Cards:*

1. Use a first (left) position disposition guide card to identify files to be transferred to the records staging area.

2. Use a second (center) position disposition guide card to identify files to be forwarded directly to a records center by the office of record (such as morning reports, personnel folders, etc.).

3. Use a third (right) position disposition guide card to identify files to be destroyed in the current files area.

It is important that *all* records following a guide card have the same retention period. These cards will remain with cut-off files

as long as they are retained in the current files area. (See figure 10 for examples.)

(b) *Replacement or Reuse of Cards:*

1. Make new sets of cards as needed for current accumulations of each records series.

2. When non-current records series are retired or destroyed, reuse the disposition guide cards for current accumulations.

(c) *Exceptions:*

1. When it isn't feasible to affix AF Form 82 to a guide card and place the guide card in front of a record series, affix the label to the container housing the records. When the series of records is housed in more than one container, affix the label to the first container.

2. Do not prepare AF Forms 82 for records maintained for a period of time but never placed in filing equipment (such as a safe check record or a room security inspection record). Instead, describe the records on AF Form 80 and enter disposition instructions immediately below the description.

(3) *Preparation:*

★(a) *Item 1 (Title or Description of Record Series).* Insert appropriate item number from AF Form 80, "Files Maintenance and Disposition Plan," and paragraph title from AFM 181-5 followed by the local title, if any. *NOTE:* When volume justifies, item number from AF Form 80 may be used to code papers for filing in series other than correspondence files.

(b) *Item 2 (Paragraph Number from AFM 181-5).* Enter applicable paragraph number of AFM 181-5. If no paragraph is applicable, enter "None."

★(c) *Item 3 (Cut-off Instructions).* Indicate day and month (omit year to permit reuse of disposition guide card) or event when records will be cut-off as prescribed in paragraph 29, AFM 181-4.

(d) *Item 4 (Disposition Instructions).* Enter following information, as appropriate:

1. If series has a short retention

period, and, can be held in available space and equipment in office of record until eligible for destruction, enter the word "Destroy" followed by the retention period (e.g., Destroy 6 months after cut-off).

2. If the series is "permanent," or, subject to a long retention period, enter the words "Transfer to Staging Area" or "Retire to Records Center," (as appropriate) followed by the period of retention in the office of record (e.g., "Transfer to staging area 2 years after cut-off"). Then, if records are temporary, give additional retention period (e.g., "Destroy after 3 additional years."); if records are permanent, so indicate. If disposition instructions are too lengthy for inclusion in this block, enter statement: "See AFM 181-5."

3. If no disposition instructions have been published enter "None." If instructions are published later, cross out "None" and enter applicable instructions.

★e. *General Correspondence Files.* These are subjectively arranged files of letters, messages, memoranda, and related documents accumulated by most offices of record. Maintenance of such files under the Air Force Subjective Classification System provides for segregation of "mission" documentation from "non-mission" (or housekeeping papers) at time of filing. This is accomplished by filing correspondence pertaining to the mission (functions and responsibilities) of the office of record under the appropriate major subjective category chosen from appendix A of this manual. All other correspondence is arranged subjectively in the "Office Administration—ADM" category as "non-mission" to the office accumulating them. Arrange correspondence files as follows to facilitate disposition:

(1) *HQ USAF, Major Air Commands, and Certain Major Subordinate Air Commands:*

(a) *Mission "Managerial" Correspondence.* Correspondence files at these levels documenting Air Force or command-wide policy making, program monitoring, and implementation of policies from higher

authority, are permanent records as provided in paragraph 050101a(1), AFM 181-5. They should be identified as a separate records series on the AF Form 80. (Correspondence accumulated by major command staff offices pertaining to functions for which they have command-wide responsibility is an example of such material.)

(b) *Mission "Operational" Correspondence.* Many offices at these levels also accumulate mission correspondence of temporary value. (Correspondence accumulated by major command staff offices pertaining to local implementation of Air Force and command directives by their immediate headquarters is an example of such correspondence.) It may be destroyed after 1 year as provided in paragraph 050101b, AFM 181-5, and should be identified as a separate item on the AF Form 80.

(c) *Non-mission Correspondence.* This category is also accumulated at these higher headquarters. It should be identified as a separate item on the AF Form 80 and disposed of after 1 year as provided in paragraph 050101a(2), AFM 181-5.

(2) *All Other Organizational Levels.* For records disposal purposes, there is no need to differentiate between "mission" and "non-mission" correspondence at these levels since both groups of correspondence are disposable after 1 year. Accordingly, identify correspondence files at these levels as 1 item on the AF Form 80 and cite paragraph 050101b, AF 181-5, as the disposal authority.

(3) *Correspondence Filed With Other Records Series.* Correspondence relating to forms or other documents filed as separate.

GENERAL SERVICES ADMINISTRATION
WASHINGTON, D. C. 20405

April 12, 1965

FEDERAL PROPERTY MANAGEMENT REGULATIONS
AMENDMENT NO. E-6

TO : Heads of Federal Agencies

SUBJECT: Revision of Subchapter E - Supply and Procurement

1. Purpose. This amendment transmits a revision of Subchapter E - Supply and Procurement.
2. Background. Federal Property Management Regulations, Temporary Regulation No. A-2, dated January 15, 1965, provided for a reduction in expenditures for office furniture and typewriters and a moratorium on the purchase of new correspondence filing cabinets. That Regulation was promulgated to give immediate effect to the letter of January 9, 1965, from the President and as stated therein expires 90 days from date of issue.
3. Explanation of changes. This revision continues in effect the provisions of FPMR Temporary Regulation No. A-2; restricts procurement of personal convenience type items; clarifies the instructions covering use standards for executive type office furniture and furnishings and provides for the use of other than executive type where such items are adequate; and requires that agencies procure items from Federal Supply Schedule contracts in lieu of procuring similar items from other sources.
 - a. Section 101-25.104 is added to provide for clarification of the restrictions intended by FPMR (T) A-2 in connection with the purchase of furniture and typewriters.
 - b. Section 101-25.105 is added to restrict procurement of personal convenience type items, unless such procurement is authorized by law.
 - c. Section 101-25.302 is revised to provide in paragraph (a), a cross-reference to § 101-25.104 pertaining to the moratorium on the purchase of new filing cabinets and reduction in the purchase of office furniture, furnishings, and equipment.
 - d. Section 101-25.302-1 is revised to clarify instructions relative to use standards for executive type office furniture and furnishings and to provide for the use of other than executive type when such items are adequate.

Attachment

e. Section 101-25.404-1 is added to provide that agencies limit acquisition of new furniture, typewriters, and filing cabinets to essential requirements as provided in § 101-25.104.

f. Section 101-26.308 is added to establish procedures for obtaining new filing cabinets from GSA.

g. Section 101-26.401 is revised as follows:

(1) A preamble is added to § 101-26.401 to provide coverage for the entire section (formerly included in § 101-26.401-1).

(2) Section 101-26.401-1 is redesignated "Mandatory use of schedules" and § 101-26.401-2 is redesignated "Primary source of supply concept."

(3) Section 101-26.401-3 is redesignated "Similar items" and requires that agencies procure items from Federal Supply Schedule contracts in lieu of procuring similar items from other sources when the Schedule items will adequately serve the required functional purpose.

(4) Section 101-26.401-4(g) is deleted.

4. Effective date. This regulation is effective April 15, 1965.

LAWSON B. KNOTT, JR.
Acting Administrator of General Services

FILING INSTRUCTIONS AND NOTES

Remove Pages

Insert Pages

i-v - Contents of Subchapter E
2501-2502
2507-2508
2511-2512
2609-2622

i-v - Contents of Subchapter E
2501-2502.1
2507-2508
2511-2512
2609-2622

(a) On each page appears the number and date (month and year) of the FPMR Amendment which transmitted it.

(b) Retention of FPMR Amendments and removed pages will provide a history of FPMR issuances and facilitate determining which regulations were in effect at particular times.

(c) Arrows printed in the margin of a page indicate material changed, deleted, or added by the FPMR Amendment cited at the bottom of that page. Where insertion of new material results in shifting of unchanged material on following pages, no arrows will appear on such pages but the FPMR Amendment transmitting such new pages will be cited at the bottom of each page.

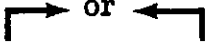
 — Line on which change begins.

 — Line on which change ends.

 — Line on which change both begins and ends.

 — Opposite a blank space, indicates deletion of a division of material (section, subsection, or paragraph).

(d) In the numbering system, all FPMR material is preceded by digit 101-. This simply means that it is Chapter 101 in Title 41 of the Code of Federal Regulations. It has no other significance. The digit(s) before the decimal point indicates the part; the digits after the decimal point indicate, without separation, the subpart and section, respectively, the latter always in two digits; and the digit(s) after the dash indicates the subsection. For example:

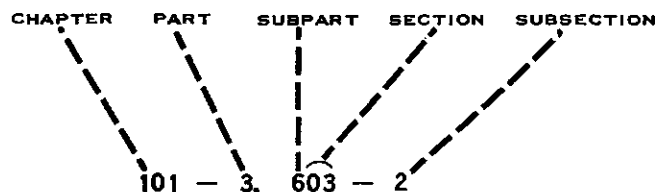

CONTENTS OF SUBCHAPTER E — SUPPLY AND PROCUREMENT

PART 101-25—GENERAL

<p>Sec: 101-25.000 Scope of subchapter. 101-25.001 Scope of part.</p> <p style="text-align: center;">Subpart 101-25.1—General Policies</p> <p>101-25.101 Criteria for determining method of supply.</p> <p>101-25.101-1 General. 101-25.101-2 Supply through storage and issue. 101-25.101-3 Supply through consolidated purchase for direct delivery to use points. 101-25.101-4 Supply through indefinite quantity requirement contracts. 101-25.101-5 Supply through local purchase. 101-25.102 Exchange or sale of personal property for replacement purposes.</p> <p>101-25.103 Trading Stamps.</p> <p>101-25.104 Acquisition of office furniture and typewriters.</p> <p>101-25.104-1 Redistribution, repair, or rehabilitation. 101-25.104-2 Purchase of new filing cabinets. 101-25.105 Restriction on personal convenience items.</p> <p style="text-align: center;">Subpart 101-25.2—Interagency Purchase Assignments</p> <p>101-25.201 General. 101-25.202 Factors to be used to determine assignment of purchase responsibility. 101-25.203 Centralized purchases by GSA. 101-25.204 Centralized purchases by designated executive agencies under authority delegated by the Administrator of General Services. 101-25.205 Arrangement for performance of purchasing functions other than centralized. 101-25.206 Independent purchases by executive agencies.</p> <p style="text-align: center;">Subpart 101-25.3—Use Standards</p> <p>101-25.301 General. 101-25.302 Office furniture, furnishings, and equipment. 101-25.302-1 Executive type office furniture and furnishings. 101-25.302-2 Filing cabinets. 101-25.302-3 Electric typewriters. 101-25.302-4 Portable computing machines. 101-25.303 Gasoline for use in motor vehicles.</p>	<p>Sec.</p> <p style="text-align: center;">Subpart 101-25.4—Replacement Standards</p> <p>101-25.401 General. 101-25.402 Motor vehicles. 101-25.403 Typewriters. 101-25.404 Furniture. 101-25.404-1 Limitations. 101-25.405 Materials handling equipment.</p> <p style="text-align: center;">Subparts 101-25.5—101-25.47 [Reserved]</p> <p style="text-align: center;">Subpart 101-25.48—Reports</p> <p>101-25.4800 Scope of subpart. 101-25.4801 Supply Activity Report.</p> <p style="text-align: center;">Subpart 101-25.49—Illustration of Forms</p> <p>101-25.4900 Scope of subpart. 101-25.4901 [Reserved] 101-25.4902 GSA forms. 101-25.4902-1473 GSA Form 1473: Supply Activity Report. 101-25.4902-1473-1 Instructions for Preparation of GSA Form 1473, Supply Activity Report.</p>
---	--

PART 101-26—PROCUREMENT SOURCES AND PROGRAMS

<p>101-26.000 Scope of part.</p> <p style="text-align: center;">Subpart 101-26.1—General</p> <p>101-26.101 First source of supply; excess personal property. 101-26.102 Special buying services. 101-26.102-1 General. 101-26.102-2 Utilization by military agencies. 101-26.103 Payments to the General Supply Fund. 101-26.104 End-of-year submission of purchase documents for action by GSA.</p> <p style="text-align: center;">Subpart 101-26.2—Federal Requisitioning System</p> <p>101-26.200 Scope of subpart. 101-26.201 General. 101-26.202 Applicability. 101-26.203 Forms required. 101-26.203-1 Forms prepared by ordering offices. 101-26.203-2 Forms furnished to ordering offices. 101-26.204 Availability of forms. 101-26.205 Implementation. 101-26.205-1 Training media. 101-26.205-2 Assignment of Codes. 101-26.206 GSA assistance.</p>

CONTENTS OF SUBCHAPTER E — SUPPLY AND PROCUREMENT

Sec.

**Subpart 101-26.3—Procurement From GSA
Stores Stock**

- 101-26.300 Scope of subpart.
- 101-26.301 Applicability.
- 101-26.301-1 Similar items.
- 101-26.302 Standard and optional forms, blankbooks, pamphlets, and miscellaneous printed matter.
- 101-26.302-1 General.
- 101-26.302-2 Agency responsibilities.
- 101-26.302-3 Obtaining items from GSA supply depots.
- 101-26.302-4 Deviations from the text or format of standard or optional forms and other printed items.
- 101-26.302-5 Obtaining specially manufactured standard or optional forms.
- 101-26.302-6 Promulgation, modification, or revision of forms and related items.
- 101-26.302-7 Information concerning changes.
- 101-26.302-8 Disposition of excess or obsolete standard forms.
- 101-26.302-9 Employee suggestions.
- 101-26.303 Out-of-stock items at GSA regional offices.
- 101-26.303-1 General.
- 101-26.303-2 Notice to GSA.
- 101-26.303-3 Exceptions.
- 101-26.304 Substitution policy.
- 101-26.305 Orders for stock items.
- 101-26.306 Planned requisitioning for GSA stock items.
- 101-26.307 Processing overages, shortages, and damages.
- 101-26.307-1 Reporting requirements.
- 101-26.307-2 Adjustments.
- 101-26.307-3 Inquiries relating to GSA shipments.
- 101-26.308 Obtaining filing cabinets.
- 101-26.308-1 Actions prerequisite to ordering filing cabinets.
- 101-26.308-2 GSA review and approval.

**Subpart 101-26.4—Purchase of Items From
Federal Supply Schedule Contracts**

- 101-26.401 Applicability.
- 101-26.401-1 Mandatory use of schedules.
- 101-26.401-2 Primary source of supply concept.
- 101-26.401-3 Similar items.
- 101-26.401-4 Exceptions to mandatory use
- 101-26.401-5 Optional use provisions.
- 101-26.402 General.
- 101-26.402-1 Schedule method of contracting.

Sec.

- 101-26.402-2 Service features.
- 101-26.402-3 Distribution.
- 101-26.402-4 Checklist and guide.
- 101-26.402-5 Contract provisions.
- 101-26.403 Performance and default under Federal Supply Schedule contracts.
- 101-26.403-1 Responsibilities.
- 101-26.403-2 Inspection.
- 101-26.403-3 Delinquent performance.
- 101-26.403-4 Disputes.
- 101-26.403-5 Default; ordering office.
- 101-26.403-6 Default; GSA.
- 101-26.403-7 Failure to collect excess costs.
- 101-26.404 Submission of requirements of gasoline, fuel oil (diesel and burner), kerosene, and solvents.
- 101-26.404-1 General.
- 101-26.404-2 Items covered.
- 101-26.404-3 Minimum quantities.
- 101-26.404-4 Instructions for submission of requirements.
- 101-26.405 Automatic data processing equipment.
- 101-26.406 U.S. Government National Credit Card for use in obtaining service station deliveries and services.
- 101-26.406-1 General.
- 101-26.406-2 Billing code.
- 101-26.406-3 Billing address.
- 101-26.406-4 Tag or registration number.
- 101-26.406-5 Methods of obtaining Standard Form 149: U.S. Government National Credit Card.
- 101-26.406-6 Notice to GSA of assignment of billing codes and billing addresses.
- 101-26.406-7 Government Printing Office waiver.
- 101-26.407 Procurement of security cabinets by Government fixed-price prime contractors.
- 101-26.407-1 General.
- 101-26.407-2 Applicability.
- 101-26.407-3 Procedure for ordering security cabinets.
- 101-26.407-4 Use and disposal of security cabinets.
- 101-26.408 Price reductions during contract period.
- 101-26.409 Multiple-award contracts.
- 101-26.409-1 Description.
- 101-26.409-2 General.
- 101-26.409-3 Justification.
- 101-26.409-4 Responsibility of ordering offices.
- Subpart 101-26.5—GSA Procurement Programs**
- 101-26.501 Purchase of new motor vehicles.

CONTENTS OF SUBCHAPTER E — SUPPLY AND PROCUREMENT

<p>Sec.</p> <p>101-26.501-1 Applicability.</p> <p>101-26.501-2 Consolidated purchase program.</p> <p>101-26.501-3 Submission of purchase authorities.</p> <p>101-26.501-4 Procurement time schedules.</p> <p>101-26.501-5 Delivery of vehicles.</p> <p>101-26.501-6 Forms used in connection with delivery of vehicles.</p> <p>101-26.501-7 Sale of vehicles.</p> <p>101-26.502 Purchase of water coolers (dispensers).</p> <p>101-26.502-1 Submission of purchase authorities.</p> <p>101-26.502-2 Types of water coolers (dispensers).</p> <p>101-26.503 Purchase of new refrigerators.</p> <p>101-26.503-1 Scope.</p> <p>101-26.503-2 Types of refrigerators.</p> <p>101-26.503-3 Submission of purchase authorities.</p> <p>101-26.504 Purchase of coal.</p> <p>101-26.504-1 General.</p> <p>101-26.504-2 Submission of requirements.</p> <p>101-26.504-3 Inspection and testing of coal deliveries.</p> <p>101-26.504-4 Procuring offices and delivery areas.</p> <p>101-26.505 Purchase of furniture and furnishings.</p> <p>101-26.505-1 General.</p> <p>101-26.505-2 Furniture and furnishing classifications.</p> <p>101-26.505-3 Determination.</p> <p>101-26.505-4 Acquisition of office furniture and furnishings.</p> <p>101-26.505-5 Acquisition of household and quarters furniture.</p> <p>101-26.505-6 Submission of purchase authorities.</p> <p>101-26.505-7 GSA assistance in selection of available furniture and furnishings.</p> <p>Subpart 101-26.6—Procurement Sources Other Than GSA</p> <p>101-26.601 Purchase of blind-made products and products manufactured by the Federal Prison Industries, Inc.</p> <p>101-26.602 Purchase of lubricating oils.</p> <p>101-26.602-1 Applicability.</p> <p>101-26.602-2 Procurement requirements.</p> <p>Subparts 101-26.7—101-26.48 [Reserved]</p> <p>Subpart 101-26.49—Illustrations of Forms</p> <p>101-26.4900 Scope of subpart.</p> <p>101-26.4901 Standard forms.</p> <p>101-26.4901-1 Standard Form No. 1: Printing and Binding Requisition.</p> <p>101-26.4901-1C Standard Form No. 1-C: Printing and Binding Requisition for Speciality Items.</p>	<p>Sec.</p> <p>101-26.4901-84 Standard Form 84: Stock Action Request (Standard Forms and Related Items).</p> <p>101-26.4902 GSA forms.</p> <p>101-26.4902-211 GSA Form 211: Estimated Gasoline Requirements.</p> <p>101-26.4902-212 GSA Form 212: Estimated Kerosene and Fuel Oil Requirements.</p> <p>101-26.4902-213 GSA Form 213: Estimated Solvent Requirements.</p> <p>101-26.4902-222 GSA Form 222: Estimated Requirements for Coal.</p> <p>101-26.4902-457 GSA Form 457: Request for Federal Supply Schedules and Contractors' Catalogs (Including Pricelists).</p> <p>101-26.4902-952 GSA Form 952: Single Line Item Billing Register.</p> <p>101-26.4902-1052 GSA Form 1052: Over, Short, and/or Damage Report.</p> <p>101-26.4902-1348 (6-PT) GSA Form 1348 (6-PT): GSA Single Line Item Requisition Document (MANUAL).</p> <p>101-26.4902-1348m GSA Form 1348m: Single Line Item Requisition System Document (MECHANICAL).</p> <p>101-26.4902-1348-1 GSA Form 1348-1: Single Line Item Release/Receipt Document.</p> <p>101-26.4902-1348-4 GSA Form 1348-4: Multi-line Requisition.</p> <p>101-26.4902-1398 GSA Form 1398: Motor vehicle purchase and inspection label.</p> <p>101-26.4902-1718 GSA Form 1718 (Multi-carboned): Unsatisfactory Equipment Report.</p> <p>101-26.4902-1781 GSA Form 1781: Motor Vehicle Requisition/Code Sheet.</p> <p>101-26.4903 FSS forms.</p> <p>101-26.4903-195 FSS Form 195: Instructions to Consignee Receiving New Motor Vehicles Purchased by GSA.</p>
---	--

PART 101-27—INVENTORY MANAGEMENT

101-27.000	Scope of part.
Subpart 101-27.1—Stock Replenishment	
101-27.101	General.

CONTENTS OF SUBCHAPTER E — SUPPLY AND PROCUREMENT

Sec.	
101-27.102	Economic order quantity principle.
101-27.102-1	Applicability.
101-27.102-2	Guidelines.
101-27.102-3	Limitations on use.
101-27.103	Acquisition of excess property

PART 101-28—STORAGE AND DISTRIBUTION

101-28.000	Scope of part.
Subpart 101-28.1—General	
101-28.100	Scope of subpart.
101-28.101	Uniform terminology.
101-28.101-1	Bay.
101-28.101-2	Bin storage area.
101-28.101-3	Bulk storage.
101-28.101-4	Bulk storage area.
101-28.101-5	Cross-servicing in storage activities.
101-28.101-6	Distribution points.
101-28.101-7	Dunnage.
101-28.101-8	Forklift truck.
101-28.101-9	Gross storage space.
101-28.101-10	Inventory.
101-28.101-11	Load length.
101-28.101-12	Locator system.
101-28.101-13	Materials handling equipment.
101-28.101-14	Pallet.
101-28.101-15	Pallet rack.
101-28.101-16	Pallet rack storage space.
101-28.101-17	Reserve points.
101-28.101-18	Section.
101-28.101-19	Space layout.
101-28.101-20	Storage.
101-28.101-21	Storage aids.
101-28.101-22	Storage space.
Subpart 101-28.2—Interagency Cross-Servicing in Storage Activities	
101-28.200	Scope of subpart.
101-28.201	Applicability.
101-28.202	G S A/D O D Cross-Servicing Agreement.
101-28.203	Definitions.
101-28.203-1	Government storage activity.
101-28.203-2	Case lot quantities.
101-28.203-3	Commodity classification.
101-28.203-4	Contact point
101-28.204	Determining location of storage activities.
101-28.205	Requests for services.
101-28.206	Cancellation of cross-servicing arrangements.
101-28.207	Cross-servicing rates.
101-28.208	Reimbursement for services.

PART 101-29—FEDERAL SPECIFICATIONS AND STANDARDS

101-29.000	Scope of part.
------------	----------------

Sec.

Subpart 101-29.1—General

101-29.101	Federal standardization documents.
101-29.102	Procedures for development of Federal standardization documents.
101-29.103	Availability of Federal standardization documents.

Subpart 101-29.2—Specifications

101-29.201	General definition of a specification.
101-29.201-1	Federal Specifications.
101-29.201-2	Interim Federal Specifications.
101-29.201-3	Military specifications.
101-29.201-4	Departmental specifications.
101-29.202	Federal Qualified Products Lists.
101-29.203	Mandatory use of Federal Specifications.
101-29.204	Exceptions to mandatory use of Federal Specifications.
101-29.205	Deviations from Federal Specifications.
101-29.205-1	Agency responsibility relative to deviations from Federal Specifications.
101-29.205-2	Limitations on continued deviations.
101-29.206	Optional use of Interim Federal Specifications.
101-29.207	Use of Federal and Interim Federal Specifications in Federal construction contracts.
101-29.208	Military and departmental specifications.

Subpart 101-29.3—Standards

101-29.301	General definition of standards.
101-29.301-1	Federal Standards.
101-29.301-2	Interim Federal Standards.
101-29.301-3	Military standards.
101-29.301-4	Departmental standards.
101-29.302	Mandatory use of Federal Standards.

PART 101-30—FEDERAL CATALOG SYSTEM

101-30.000	Scope of part.
------------	----------------

Subpart 101-30.1—General

101-30.100	Scope of subpart.
101-30.101	Definitions.
101-30.101-1	Cataloging.
101-30.101-2	Cataloging activity.
101-30.101-3	Civil agency items.
101-30.101-4	Conversion.
101-30.101-5	Federal Catalog System.
101-30.101-6	Federal item identification.
101-30.101-7	Item of supply.
101-30.102	Objectives.
101-30.103	Responsibilities.

CONTENTS OF SUBCHAPTER E — SUPPLY AND PROCUREMENT

Sec.

- 101-30.103-1 General.
- 101-30.103-2 Agency responsibilities.

Subpart 101-30.2—Cataloging Handbooks and Manuals

- 101-30.201 General.
- 101-30.202 Policies.

Subpart 101-30.3—Cataloging Items of Supply

- 101-30.300 Scope of subpart.
- 101-30.301 Types of items to be cataloged.
- 101-30.302 Types of items excluded from cataloging.
- 101-30.303 Identification.

Subpart 101-30.4—Use of the Federal Catalog System

- 101-30.400 Scope of subpart.
- 101-30.401 Publication of Federal catalog data.
 - 101-30.401-1 Data for military agencies.
 - 101-30.401-2 Data for civil agencies.
 - 101-30.401-3 Federal item identification cards.
- 101-30.402 Conversion.
- 101-30.403 Utilization.
 - 101-30.403-1 Reports of excess and surplus personal property.
 - 101-30.403-2 Management codes.

Subpart 101-30.5—Maintenance of the Federal Catalog System

- 101-30.500 Scope of subpart.

Sec.

- 101-30.501 Maintenance.
- 101-30.502 Assistance by Government suppliers.

PART 101-31—INSPECTION AND QUALITY CONTROL

- 101-31.000 Scope of part.

Subpart 101-31.1 [Reserved]

Subpart 101-31.2—Use of Private Inspection, Testing, and Grading Services

- 101-31.200 Scope of subpart.
- 101-31.201 Definition of private organizations.
- 101-31.202 Testing services.
- 101-31.203 Inspection and grading services.
- 101-31.204 Arranging for inspection, testing, or grading by private organizations.
- 101-31.205 Referral to Comptroller General.

PART 101-32—PART 101-34 [RESERVED]

§ 101-25.000 Scope of subchapter.

This subchapter provides policies and guidelines pertaining to the general area of supply management designed to support the logistical programs of the Federal Government. It consists of Parts 101-25 through 101-34 and provides for applicability of coverage within each of these several parts.

§ 101-25.001 Scope of part.

This part provides policies and guidelines pertaining to subject matter in the general area of supply management which is not appropriate for coverage in other parts of this Subchapter E.

Subpart 101-25.1—General Policies**§ 101-25.101 Criteria for determining method of supply.****§ 101-25.101-1 General.**

(a) This § 101-25.101 prescribes general criteria governing selection of the appropriate methods of supply to be utilized in meeting the planned requirements of the Government. It is directly applicable to executive agencies, and other Federal agencies are requested to observe these criteria in conducting their supply operations.

(b) As used in this § 101-25.101, the term "use point" means a storeroom or other redistribution point where supplies, materials, or equipment representing more than a 30-day supply are maintained primarily for issue directly to consumers within the local area, as distinguished from storage points where supplies and equipment are issued to redistribution points.

§ 101-25.101-2 Supply through storage and issue.

The following criteria shall govern in determining whether an item can be most advantageously supplied through storage and issue to use points:

(a) The item shall be physically adaptable to storage and issue and of such a character that it is feasible to forecast overall requirements of the use points served with reasonable accuracy;

(b) Rate of use and frequency of ordering at use points shall be sufficient to warrant storage and issue;

(c) The rate of deterioration or obsolescence shall be sufficiently low to avoid unnecessary loss; and

(d) Conditions exist where any of the following factors require supply through storage and issue (except that dangerous commodities of high weight and density, or commodities highly susceptible to damage normally should not be considered for supply through storage and issue unless one or more of such factors are determined to be of overriding importance)—

(1) Where price advantage through bulk buying is sufficient to render storage and issue more economical, all costs, both direct and indirect, considered.

(2) Where close inspection or testing is necessary to secure quality, or where repetitive inspection and test of small lots are prohibitive from the standpoint of cost or potential urgency of need.

(3) Where advance purchase and storage are necessitated by long procurement leadtime.

(4) Where an item is of special manufacture or design and is not readily available from commercial sources.

(5) Where an adequate industry distribution system does not exist to assure availability at use point.

(6) Where volume purchases are necessary to secure timely deliveries and advantageous prices.

(7) Where market conditions are such that supply through storage and issue is required to assure adequate supply.

(8) Where stocking of supplies and equipment necessary for implementation of emergency plans is required for an indefinite period.

§ 101-25.101-3 Supply through consolidated purchase for direct delivery to use points.

The following criteria shall govern in determining whether an item can be most advantageously supplied through consolidated purchase for direct delivery to use points:

(a) The items shall be equipment or supply items of such a character that it is feasible to forecast requirements for delivery to specific use points; and

(b) Conditions exist where any of the following factors requires consolidated purchasing of such items for direct delivery to use points—

(1) Where greatest price advantage, both direct and indirect costs considered, is obtainable through large definite quantity purchasing.

PART 101-25 GENERAL

101-25.101-3(b)(2)

(2) Where an item is of special manufacture or design and is not readily available from commercial sources.

(3) Where market conditions are such that central procurement is required to assure adequate supply.

(4) Where contracts for production quantities are necessary to secure timely deliveries and advantageous prices.

(5) Where the quantity is large enough to assure lowest transportation costs or, conversely, where transportation costs for small quantity redistribution are so excessive that it is not feasible to store and issue the items.

§ 101-25.101-4 Supply through indefinite quantity requirement contracts.

The following criteria shall govern in determining whether an item can be most advantageously supplied through the medium of indefinite quantity requirement contracts covering specific periods and providing for delivery to use points as needs arise:

(a) The item shall be such a character that—

(1) Handling on a storage and issue basis is not economically sound, under the criteria prescribed in § 101-25.101-2;

(2) Rate of use and frequency of ordering at use points is estimated to be sufficient to warrant the making of indefinite quantity requirement contracts;

(3) It is either not feasible to forecast definite requirements for delivery to specific use points (as in the case of new items initially being introduced into a supply system), or no advantage accrues from doing so; and

(b) Industry distribution facilities are adequate properly to serve the use points involved; and

(c) Conditions exist where any of the following factors requires the maintaining of indefinite quantity requirement contracts—

(1) Advantage to the Government is greater than would be secured by definite quantity procurements by individual offices or agencies (the determining consideration being one of overall economy to the Government, rather than one of direct comparison of unit prices of individual items obtainable through other methods of supply); or no known procurement economies would be effected but the requirements

of offices or agencies can best be served by indefinite quantity requirements contracts.

(2) Acute competitive bidding problems exist because of highly technical matters which can best be met on a centralized contracting basis.

(3) The item is proprietary or so complex in design, function, or operation as to be noncompetitive and procurement can best be performed on a centralized contracting basis.

§ 101-25.101-5 Supply through local purchase.

The following criteria shall govern in determining whether an item should be supplied through local purchase:

(a) Urgency of need requires local purchase to assure prompt delivery;

(b) The items are perishable or subject to rapid deterioration which will not permit delay incident to shipment from distant points;

(c) The local purchase is within applicable limitation established by the agency head; or

(d) Local purchase will produce the greatest economy to the Government.

§ 101-25.102 Exchange or sale of personal property for replacement purposes.

Policies and methods governing executive agencies in exercising the authority granted under section 201(c) of the Federal Property and Administrative Services Act of 1949, as amended (40 U.S.C. 481(c)), are prescribed in Part 101-43.

§ 101-25.103 Trading stamps.

Policy relative to trading stamps received in connection with Government purchases is prescribed in Part 101-43.

§ 101-25.104 Acquisition of office furniture and typewriters.

Each executive agency shall make a determination as to whether the requirements of the agency can be met through the utilization of already owned items prior to the acquisition of new furniture or typewriters. The acquisition of new items shall be limited to those requirements which are considered absolutely essential and shall not include upgrading to improve appearance, office decor, status, or to satisfy the desire for the latest design or more expensive lines.

SUBPART 101-25. 1 GENERAL POLICIES

101-25.105

(a) Generally, acquisition of additional furniture or typewriters from any source will be authorized only under the following circumstances, limited to the least expensive lines which will meet the requirement (see § 101-26.409 with respect to typewriters) and the justification for the action fully documented in the agency file:

(1) For essential requirements arising from quantitative increases in onboard employment which constitute the total requirement of any agency or major component thereof (e.g. bureau, service, office).

(2) For essential requirements arising from a need not related to onboard employment increases but which are determined necessary to avoid impairment of program efficiency.

(b) Restrict replacement of furniture or typewriters either to usable excess, rehabilitated, or the least expensive lines of new furniture determined to meet the requirement under the following circumstances, authority for which shall be fully documented in the agency file:

(1) Where the agency determines that the item is not economically repairable.

(2) Where reductions in office space occupancy are accomplished through use of more convenient or smaller size furniture and the space economies thus achieved offset the cost of the furniture to be acquired.

§ 101-25.104-1 Redistribution, repair, or rehabilitation.

Prior to the purchase of new office furniture and typewriters, agencies shall

fulfill needs insofar as practicable through redistribution, repair, or rehabilitation of already owned furniture and typewriters. In furtherance of the use of rehabilitated furniture and typewriters, agencies shall review inventories on a continuing basis to ascertain those items which can be economically rehabilitated and institute programs for their orderly repair and rehabilitation. All such items which are not required for immediate needs shall be reported as excess.

§ 101-25.104-2 Purchase of new filing cabinets.

On the basis of the moratorium declared by the President, executive agencies shall not purchase new correspondence filing cabinets for use in the 50 States and the District of Columbia. Where agency needs for filing cabinets have been established and approved by GSA, acquisition may be accomplished through GSA (see § 101-26.308). This restriction does not apply to fire resistant insulated file cabinets and those required for storage of classified records designated as security file cabinets by GSA.

§ 101-25.105 Restriction on personal convenience items.

Government funds shall not be expended for pictures, objects of art, plants or flowers (both artificial and real) or any other similar type items intended for the personal convenience or to satisfy personal desire of the official or employee, unless authorized by law.

(NEXT PAGE IS 2503)

SUBPART 101-25.3 USE STANDARDS

101-25.302-2 (c)

Subpart 101-25.3—Use Standards § 101-25.301 General.

(a) This subpart prescribes minimum use standards for certain Government-owned personal property which shall be applied by all executive agencies. Additional criteria above these minimum standards should be established by each executive agency, limiting its property to the minimum requirements necessary for the efficient functioning of the particular office concerned.

(b) Additional use standards should be established by all executive agencies for other Government-owned property under their control whenever use standards will effect economy and efficiency in the use of such property.

(c) All items of property, determined to be excess to the needs of an agency as a result of the application of use standards, shall be promptly reported in accordance with Part 101-43.

§ 101-25.302 Office furniture, furnishings, and equipment.

(a) Each executive agency shall establish criteria for the use of office furniture, furnishings, and equipment. Such criteria shall be in consonance with the provisions of § 101-25.104 pertaining to office furniture and typewriters and shall be limited to the minimum essential requirements as established by the agency head for authorized functions and programs which will, beyond a reasonable doubt, be in operation within the following six months.

(b) In developing such criteria, a distinction shall be made between the requirements of organizational elements concerned with purely administrative functions, and those of a technical, scientific, or specialized nature.

(c) Items of office equipment, used only occasionally, should be pooled within an agency and made available to activities of the agency when and as necessary.

§ 101-25.302-1 Executive type office furniture and furnishings.

The use of executive type office furniture and furnishings shall be limited to personnel in Grade GS-15 and above, or the equivalent thereto. Executive type office furniture and furnishings includes all items utilized to equip and furnish

offices and suites which are of the quality included in the Federal Supply Schedule, "Executive Type Office Furniture" or Federal Specifications and Standards which have "executive type" in their title. However, each agency shall utilize other than executive type office furniture and furnishings available from GSA Stores Stock or Federal Supply Schedules where items obtainable from such sources will adequately serve the required functional purpose.

(a) In cases where executive type furniture actually in use cannot be readily replaced by other types within an agency, exceptions to this limitation on the use of executive type furniture and furnishings may be granted.

(b) The standard prescribed by this § 101-25.302-1 shall not apply to unitized or built-in furniture in an installation. In instances where lack of space is a problem, the use of unitized furniture, including conference desks, is more economical and is recommended as a substitute for executive type office furniture.

§ 101-25.302-2 Filing cabinets.

Executive agencies shall make every effort to effect maximum use of filing cabinets and to limit the purchase of new equipment. Filing cabinets should be replaced only in accordance with the standards in Subpart 101-25.4. Maximum utilization of equipment should be obtained by:

(a) Disposing of all records that have been authorized for disposition by the Congress or, where such authorization has not been obtained, through the preparation and obtaining of authorized disposal schedules with the assistance of the National Archives and Records Service of GSA.

(b) Removing office supplies, publications, and other nonrecord material from filing cabinets to more suitable storage equipment, except where the quantity of such material is small (as a rule, less than half a cabinet).

(c) Transferring to Federal Records Centers or approved agency records centers (to the extent that facilities are made available) inactive records not needed in daily business but not yet ready for disposal, when filing equipment can be released by such action.

PART 101-25 GENERAL

101-25.302-2(d)

(d) Shifting less active files, not transferable to approved records centers, to wood cabinets or transfer cases when available, using steel filing cabinets only when files are constantly used.

(e) Using filing cabinets with locks only when required by special needs that cannot be satisfied less expensively.

(f) Using letter-size filing cabinets instead of legal-size whenever possible.

(g) Using 5-drawer filing cabinets whenever available in lieu of 4-drawer cabinets.

§ 101-25.302-3 Electric typewriters.

(a) Each agency shall restrict the use of each electric typewriter to a typing station, which is an assigned post filled by an experienced operator for the purpose of preparing typewritten material, where one or more of the following standards are met:

(1) The typing time averages four hours or more of routine typing per machine daily.

(2) The typing time averages two hours or more per machine daily in the preparation of one or more of the following:

(i) Forms requiring an original and five or more carbons, or correspondence requiring an original and seven or more carbons.

(ii) Reproduction copy, such as photo masters and stencils.

(iii) Statistics and reports requiring decimal tabulation.

(3) The machine is used in the preparation of copy for printing. The assignment of proportional spacing machines shall be limited to this use, unless otherwise specifically justified under paragraph (b) of this section.

(4) The machine is used by the physically handicapped.

(b) Exceptions to the above criteria may be granted upon written justification approved by the head of the agency or his authorized representative and made a part of the purchase file.

§ 101-25.302-4 Portable computing machines.

Standards for the use of portable computing machines shall be established by

each agency, using as a base the minimum standards prescribed in this § 101-25.302-4. Portable computing machines include adding machines, calculators, and comptometers, manually or electrically operated, listing or nonlisting, but do not include posting or accounting machines.

(a) When the need for a machine has been determined, the following standards shall be used in determining the type of machine to be acquired:

(1) Manual machines should be used where electric current is not conveniently available or portability is required, where reasonable protection is desired against emergency shutdown (for example, in the event of continued power failures or civil defense dispersal), or where limited requirement does not warrant electric machines. Electric machines should be used in all other instances.

(2) Listing machines should be used where it is definitely determined that a printed result is necessary to the operation.

(3) Calculators or comptometers shall be used where the operation to be performed contains a volume of work which is impractical of accomplishment by the use of slide rules, computation tables, or adding and subtracting machines.

(b) Features required in a machine for a particular operation should be determined in advance and makes and models of machines having such features should be evaluated carefully with a view to the selection of the machine which will result in the lowest overall cost to the Government.

§ 101-25.303 Gasoline for use in motor vehicles.

(a) Each agency shall, except as provided in § 101-25.303(b), use regular grade gasoline in the operation of its motor vehicles, the majority of which have engines designed to render unimpaired performance with use of regular grade gasoline.

(b) The use of premium grade gasoline shall be restricted to:

(1) Vehicles whose engines are specifically designed for and require a higher octane fuel than regular grade

SUBPART 101-25.4 REPLACEMENT STANDARDS

101-25.403 (b)

Subpart 101-25.4—Replacement Standards

§ 101-25.401 General.

This subpart prescribes minimum replacement standards to be used by executive agencies desiring to replace specified types of items indicated in this subpart. Executive agencies shall retain items which are in usable and workable condition even though the standard permits replacement, provided the item can continue to be used or operated without excessive maintenance cost or substantial reduction in trade-in value.

§ 101-25.402 Motor vehicles.

If a motor vehicle has been wrecked or damaged (including wear caused by abnormal operating conditions) beyond economical repair, such unit may be replaced without regard to the standards in this § 101-25.402 after certification to that effect by the head of the agency or his designee. The standards prescribed in this § 101-25.402 are not applicable to the Department of Defense.

(a) Passenger cars and station wagons may be replaced when they have been operated for six years or 60,000 miles, whichever occurs first.

(b) Ambulances may be replaced when they have been operated for seven years or 60,000 miles, whichever occurs first.

(c) Buses for 11 or more passengers may be replaced when they have been operated for eight years. Without regard to years of use, such buses may be replaced when they have been operated the following number of miles:

	Miles
Intercity-type bus.....	280,000
City-type bus.....	150,000
School-type bus.....	80,000

(d) Multiple-drive (4- or 6-wheel drive) truck-chassis combination personnel and property carrying motor vehicles may be replaced when they have been operated for six years or 40,000 miles, whichever occurs first.

(e) Motor trucks provided with pickup or express, panel or sedan-delivery, carryall, van, open van, platform, stake, rack, dump, truck-tractor, or tank bodies may be replaced in accordance with the

following table of years or mileage operation, whichever occurs first:

Maximum GVW pounds	Total years	Total miles	Pay load rating
Less than 12,500.....	6	50,000	1 ton and less.
12,500 through 16,999.....	7	60,000	1½ through 2½ tons.
17,000 and over.....	9	80,000	3 tons and over.

(f) Where a bureau or comparable organizational unit owns eight or more vehicles in any one of the following classes, not more than 25 percent of the vehicles in such class may be replaced in any one fiscal year. Where the total number of vehicles in any one class is less than eight, not more than two of such vehicles may be replaced in any fiscal year. However, all vehicles to be replaced shall meet the age or mileage replacement standards contained in this § 101-25.402.

- (1) Automobiles (sedans, coupes, etc.).
- (2) All other passenger-carrying vehicles (station wagons, ambulances, buses).
- (3) All trucks and truck tractors.

§ 101-25.403 Typewriters.

(a) Replacement of a typewriter shall not be made unless the estimated cost of necessary repairs or reconditioning of each typewriter being replaced equals or exceeds, at lowest available rates, the percentage of replacement cost in lieu of repair or reconditioning, based on the year after year of manufacture as shown by the manufacturer's serial number. This is shown in the following percentage scale.

Year:		Percentage of replacement cost
Second	-----	80
Third	-----	80
Fourth	-----	80
Fifth	-----	70
Sixth	-----	70
Seventh	-----	60
Eighth	-----	50
Ninth	-----	40
Tenth	-----	30
Eleventh	-----	20
Twelfth	-----	10

(b) An example of the application of the "Standard Replacement Cost Percentage Scale" to a typewriter costing \$109 is as follows:

PART 101-25 GENERAL

101-25.403(b)

Year	Assumed trade-in or sale value	Replacement cost	Estimated repair cost justifying replacement
Second.....	\$50.00	\$59.00	\$47.20
Third.....	50.00	59.00	47.20
Fourth.....	50.00	59.00	47.20
Fifth.....	45.00	64.00	44.80
Sixth.....	45.00	64.00	44.80
Seventh.....	45.00	64.00	38.40
Eighth.....	45.00	64.00	32.00
Ninth.....	40.00	69.00	27.60
Tenth.....	37.50	71.50	21.45
Eleventh.....	37.50	71.50	14.30
Twelfth.....	30.00	79.00	7.90

(c) When unusual circumstances justify replacement of a typewriter at a date earlier than would be permitted by application of the "Standard Replacement Cost Percentage Scale," a written justification for such replacement shall be prepared by the head of the executive agency or his designated representative, and the replacement of the typewriter may be made. The justification shall be retained as a part of the requisitioning file of the agency.

§ 101-25.404 Furniture.

(a) Items of office furniture, household and quarters furniture, and hospital and institutional type furniture, whether made of metal, wood, or other material, may be replaced by new items only when:

(1) It is determined that replacement is essential for the efficient and economical performance of the functions of the agency in accordance with the criteria established by the head of the agency concerned which may include such factors as extreme obsolescence, or use of built-in or unitized furniture to meet space problems.

(2) The estimated cost of necessary rehabilitation thereof at lowest available rates, including any transportation expense, equals or exceeds 55 percent of the current GSA Stores Stock Catalog price, the Federal Supply Schedule price, or current market price of new items of the same type and class.

(b) The 55 percent criterion prescribed in § 101-25.404(a)(2) is the minimum standard and may be exceeded when it is to the advantage of the Government to do so. Executive agencies may rehabilitate items of furniture subject to replacement under the standard when the rehabilitation improves the appearance and operation of the item and the life expectancy is extended for an additional period of time.

§ 101-25.404-1 Limitations.

Notwithstanding the provisions in § 101-25.404 agencies shall limit acquisition of new office furniture and typewriters to essential requirements as provided in § 101-25.104. Replacement of correspondence filing cabinets will be governed by the provisions of § 101-26-308.

§ 101-25.405 Materials handling equipment.

(a) Except as provided in § 101-25.405 (b) and (c), materials handling equipment shall not be replaced unless the estimated cost of necessary one-time repair or reconditioning of each piece of equipment equals or exceeds, at lowest available rates, the percentage of replacement cost shown in column 3 of the following table. It is imperative that equipment which has exceeded its years of expected economical use be continued in service as long as it is in usable and workable condition and the one-time repair costs do not exceed the last percentages in column 3 of the table. When, due to extenuating circumstances, it is necessary to expend for repair a larger amount than allowable by the table, and if such major repair job increases the life expectancy of the equipment, the repair limits shown in the table need not be strictly adhered to for subsequent repairs of such equipment.

SUBPART 101-26.3 PROCUREMENT FROM GSA STORES STOCK

101-26.303-2 (a)

(6) Even though a standard form is not to be stocked by GSA the same procedures as set forth in this paragraph (a) will be followed except that 100 copies of the new or revised form shall be delivered to GSA Region 3 as soon as copies of the form are published.

(b) *Agency forms and miscellaneous items.* When an agency desires to utilize the storage and distribution facilities of GSA for the Government-wide distribution of its forms or publications, its request shall be submitted on Standard Form 84 to GSA Region 3. The request should include a description or sample copy of the item, recommended distribution points, estimated annual usage, and any other pertinent factors. Upon approval by GSA, the procedure established in paragraph (a) of this section shall be followed.

§ 101-26.302-7 Information concerning changes.

(a) Agencies will be notified of additions, revisions, and deletions of standard and optional forms through changes to the Standard and Optional Forms Facsimile Handbook. Such notifications will include information as to the official availability schedule for latest editions, identification of usable editions, disposal of existing stocks, and other pertinent information for use by agencies' forms management personnel.

(b) Notifications of the availability date for new or revised standard or optional forms will be released by GSA as soon as a firm commitment for delivery has been received from the Government Printing Office. Where a revision does not obsolete previous editions, which are to be used until exhausted, supplies of the revised editions may not be available for a considerable time after announcement of the revision. In such cases, all agency requisitions will be filled with the earliest usable edition stocked by the GSA supply depots, with later editions being issued as stocks of previous editions become depleted.

§ 101-26.302-8 Disposition of excess or obsolete standard forms.

(a) Standard forms which are excess to the needs of an agency shall be reported to GSA in the same manner as other excess personal property pursuant to Part 101-43 of this chapter.

(b) Reports by the military services of excess standard forms may be made to GSA Region 3, by consolidated letter report or submission of Standard Form 120, Report of Excess Personal Property.

(c) Obsolete forms should not be reported but should be determined to be surplus and disposed of under the provisions of Part 101-45 of this chapter. Obsolete accountable forms must be mutilated in the process of disposition and the accountability record closed by noting the action taken.

§ 101-26.302-9 Employee suggestions.

Employee suggestions affecting any of the items included in this § 101-26.302 shall be evaluated first within the agency where the suggestion originates, then submitted to the agency shown on the form as the promulgating agency. Where the physical characteristics of the item or its stocking or distribution are involved, the promulgating agency shall consult with GSA Region 3, before taking final approval action on the suggested change.

§ 101-26.303 Out-of-stock items at GSA regional offices.

§ 101-26.303-1 General.

Generally, back-ordering by GSA of out-of-stock items is more advantageous to requisitioning agencies than canceling the items, as an order priority is established which assures shipment within a reasonable time. Further, reordering by the requisitioning agency from another source of supply is eliminated. However, out-of-stock items will not be back-ordered when they are urgently needed and the agency prefers to procure them from local sources, or when the overall cost to the Government can be reduced by purchase of such items from local sources.

§ 101-26.303-2 Notice to GSA.

(a) When submitting orders for stock items, agencies may request GSA regional offices to cancel any or all items not available by indicating on the order, "Cancel Out-of-Stock Items" or "Cancel the Following Lines if Out-of-Stock * * *". The requests shall be based upon a determination by the agency that the item or items are urgently needed and are available from local sources, or that the overall cost

PART 101-26 PROCUREMENT SOURCES AND PROGRAMS

101-26.303-2 (a)

to the Government will be reduced. In such cases, out-of-stock items will be canceled and may be purchased without further clearance from GSA.

(b) Unless otherwise notified, a back-order will be established for each out-of-stock item and the agency notified of the approximate date when shipment will be made. Upon receipt of such notification, the ordering agency will (1) determine if the shipping date will meet its needs, considering the practicality of local purchase of interim requirements, and accept the back-order, (2) request a suitable substitute item, or (3) request cancellation of the back-order if the item or items are urgently needed, or if local procurement would be in the best interest of the Government. GSA regional offices will approve the cancellation or advise the requisitioning office of any other action taken. The requisitioning office shall await reply from the regional office before procuring its requirement elsewhere.

§ 101-26.303-3 Exceptions.

Standard forms, office furniture, and blind and prison-made items which are temporarily out-of-stock will be back-ordered in all cases and notification furnished as to the expected delivery date. However, blind or prison-made items may be procured from commercial sources by requisitioning agencies to the extent indicated in § 101-26.301(D). If such action is taken, the requisitioning agency shall request cancellation of pertinent back-orders established by the GSA regional office.

§ 101-26.304 Substitution policy.

In supplying items requisitioned from GSA depot stock, GSA regional offices will substitute both regular and excess property without prior notification, unless the proposed substitute is used, reconditioned, or differs in some substantial characteristic from the item requisitioned. Notice of intent to substitute will be given in all cases and, if desired, an opportunity will be provided to inspect the substitute prior to shipment.

§ 101-26.305 Orders for stock items.

(a) Orders for items of stock to be shipped to users within the continental United States shall be submitted in original only. Orders for items for export shipment (including shipments to Alaska

and Hawaii) shall be submitted in duplicate. Orders in FEDSTRIP format shall be submitted as prescribed in Subpart 101-26.2.

(b) The information shown on agency orders will be used by GSA to prepare invoice-shipping documents mechanically. Copies of these documents will be used to inform requisitioning agencies of the supply action taken on each item ordered, as packing lists to assist consignee points in checking incoming shipments, and for subsequent billing for merchandise shipped.

§ 101-26.306 Planned requisitioning for GSA stock items.

In placing requisitions for GSA stores stock items with GSA regional offices, agencies shall follow schedules or cyclical plans, for replenishment of stocks, which will adjust the number of transactions to the most economical level consistent with ordering frequencies which are required to comply with the economic order quantity principle (see § 101-27.102).

§ 101-26.307 Processing overages, shortages, and damages.

§ 101-26.307-1 Reporting requirements.

(a) When overages, shortages, or damages are incurred in shipments of stores stock items made by GSA, agencies shall document such discrepancies with sufficient information to enable initiation and processing of claims against carriers for shortages and damages and the disposition of any overages and shortages in shipment.

(b) GSA Form 1052, Over, Short, and/or Damage Report (illustrated at § 101-26.4902-1052), shall be used to report discrepancies in accordance with instructions contained in this § 101-26.307 and the GSA Handbook, "Over, Short, or Damaged Shipments from GSA Supply Depots", promulgated by the Commissioner, Federal Supply Service. GSA Form 1052 is stocked in GSA Supply Depots under Stock Number 7540-965-2403. Agency requirements should be ordered in the same manner as standard and optional forms.

(c) Delay in submission of over, short, and damage reports, including those cov-

SUBPART 101-26.3 PROCUREMENT FROM GSA STORES STOCK

101-26.308-2

ering shipper discrepancies, will delay GSA adjustment action and may complicate claims action against carriers. Accordingly, reports shall be prepared promptly and mailed in sufficient time to be received by the GSA regional office no later than 15 days after receipt of shipment.

§ 101-26.307-2 Adjustments.

GSA will adjust any damage or other discrepancy resulting from over or under deliveries or from over or under charges. When the difference involved represents an amount of \$5 or less on any one invoice, no adjustment in billing or payment is required. (GAO Manual, Title 7, Paragraph 4220.30). However, agencies are not relieved from the requirement to report discrepancies on GSA Form 1052 when the value involved is less than \$5.

§ 101-26.307-3 Inquiries relating to GSA shipments.

Inquiries relating to GSA shipments should be directed to the appropriate addressee of the GSA regional office shown in the current edition of the GSA Stores Stock Catalog.

§ 101-26.308 Obtaining filing cabinets.

Agency requirements for correspondence filing cabinets for use in the 50 States and the District of Columbia will be made the subject of a letter to the appropriate GSA Regional Administrator specifying the stock numbers and quantities required by consignee point(s) and stating that the actions prescribed in § 101-26.308-1 have been taken but have not produced the needed filing cabinets.

§ 101-26.308-1 Actions prerequisite to ordering filing cabinets.

Prior to initiating letter requests to GSA for filing cabinets, agencies shall assure that the following actions have been taken.

(a) Agency records have been disposed of in accordance with authorized schedules.

(b) Retention periods of records no longer required have been reduced to the absolute minimum.

(c) Inactive records have been retired to Federal Records Centers. (These centers will accept records which are not immediately disposable and which

are not referred to more than once per file drawer per month, provided transportation charges are not in excess of space and equipment savings.)

(d) Records have been retired in accordance with agency procedures to agency records centers, agency staging or holding areas, and other agency center-type space where records can be stored economically in cartons on shelves or in other low-cost equipment.

(e) Contents of filing cabinets have been rehoused in more economical equipment where appropriate. (For example, shelf filing should be considered for records, and shelving, storage cabinets, and similar equipment should be used for stocks of forms, publications, and office supplies.)

(f) Filing cabinets are being fully utilized, including top and bottom drawers. (Fill cabinet drawers to the optimum extent to still permit ready filing and finding (usually $\frac{3}{4}$ full). Consolidate contents of cabinets that are less than half full.)

(g) Filing cabinets have been redistributed within the agency to meet needs for special types and sizes of cabinets.

(h) Stocks of filing cabinets have been reduced to immediate needs and any unneeded cabinets have been reassigned to points of shortage within the agency or reported as excess to GSA for redistribution to other Federal agencies.

(i) Advice and assistance as needed have been requested from agency records officers and from records management specialists in GSA regional offices and Federal Records Centers.

The criteria established in this § 101-26.308-1 will assist agencies to attain the goal of reducing the quantity of records in agency office space to no more than half the total quantity of agency records, including those in center-type space.

§ 101-26.308-2 GSA review and approval.

GSA will review the agency requests for conformance with records management objectives particularly as pertains to accelerated disposal of records and the use of less expensive substitutes for filing cabinets by the requesting agency.

PART 101-26 PROCUREMENT SOURCES AND PROGRAMS

101-26, 308-2

If the need for the filing cabinets is approved, excess items of the type requested will be furnished, if available. Serviceable substitutions irrespective of composition (wood or metal), number of drawers, or finish will be issued. Approved requests which cannot be filled from excess will be returned to the originator with GSA Form 2084, Clearance to Acquire Correspondence Filing Cabinets, reflecting a FC (file cabinet) clearance number authorizing submission of a requisition to the GSA regional office.

(a) When the clearance document is received from GSA, the document number shall be incorporated in the remarks field of the FEDSTRIP-MILSTRIP requisition and the designator E entered in the third position of the document identifier. Requisitions in non-FEDSTRIP-MILSTRIP format shall also include the clearance document number.

(b) A copy of the clearance document shall be mailed with the requisition.

SUBPART 101-26.4 PURCHASE OF ITEMS FROM FEDERAL SUPPLY SCHEDULE CONTRACTS

101-26.401-4(a) (1)

Subpart 101-26.4—Purchase of Items From Federal Supply Schedule Contracts

§ 101-26.401 Applicability.

All executive agencies shall procure needed articles and services from Federal Supply Schedule contracts in accordance with the provisions of the appropriate Federal Supply Schedule.

(a) The general principles and methods prescribed in this Subpart 101-26.4 apply to all such procurement. Consequently, prior to initiating procurement directly from commercial sources, agency activities shall determine whether the required item or a similar item serving the required functional purpose is available from a Federal Supply Schedule.

(b) The Federal Supply Schedule Checklist and Guide (see § 101-26.402-4) is a ready reference for information on the availability of items from a Federal Supply Schedule.

§ 101-26.401-1 Mandatory use of schedules.

Except for the Schedule covering Motor Vehicle Parts and Accessories (FSC Groups 25, 28, 29, 38, and 39) which is completely optional, Federal Supply Schedules are mandatory, in whole or in part, on at least one element of the executive branch of the Government. For the delivery areas specified, this mandatory coverage may be generally applicable to all executive agencies as in the case of Schedules covering common-use administrative and maintenance type items or, as in the case of newly developed Schedules, may be applicable to only one or a small number of agencies. The Federal Supply Schedule Checklist and Guide provides summary information as to mandatory coverage of each Schedule. However, the particular Schedule involved should be reviewed for complete information concerning any exceptions. In the event of any conflict between the provisions of the Checklist and those of the Schedule, those of the Schedule shall govern. The mandatory use of Schedules is applicable as and to the extent provided in § 101-26.401-2 through § 101-26.401-4.

§ 101-26.401-2 Primary source of supply concept.

Schedules issued prior to fiscal year 1963 list the agencies subject to manda-

tory use provisions under the caption "Mandatory Use." That caption is being progressively omitted as new Schedules are issued. Each such Schedule contains a "Scope of Contract" statement identifying specific agencies in designated geographic areas required to use the established contracts as "primary sources of supply." Agencies so identified will, except as provided in § 101-26.401-4, use the Schedule on a mandatory basis and the established contracts will be primary sources of supply for the items involved.

§ 101-26.401-3 Similar items.

Agencies required to use Federal Supply Schedule contracts shall obtain needed items from this source in lieu of procuring similar items from other sources when the Federal Supply Schedule item will adequately serve the required functional purpose.

(a) Where an agency determines that items available from Federal Supply Schedule contracts will not serve the required functional end use requirements, requests to waive the requirement for procuring the Federal Supply Schedule items shall be submitted to GSA for consideration. Requests for waivers shall (1) describe the pertinent differences between the Federal Supply Schedule item and the item required; (2) specify the quantity required; and (3) state the reasons why the Federal Supply Schedule item will not meet the requirement.

(b) Requests for waivers shall be submitted to the contracting office at the address shown on the front cover of the Federal Supply Schedule.

§ 101-26.401-4 Exceptions to mandatory use.

(a) *Delivery requirements.* (1) When the delivery period offered in the Federal Supply Schedule does not meet the delivery requirements of the purchasing activity, use of the Federal Supply Schedule is not mandatory. However, delivery dates shown in Federal Supply Schedules are based upon the average capability of the contractor and are usually conservative. Contractors, in most instances, are able to make delivery within a shorter period of time than the maximum provided in the Schedule. Therefore, when the delivery requirements of the purchasing activity are less than the maximum shown in the Sched-

PART 101-26 PROCUREMENT SOURCES AND PROGRAMS

101-26.401-4(a)(1)

ule, the contractor should be queried as to whether the delivery requirements can be met. This procedure shall be followed except in those cases where transportation time from the contractor's shipping point or time required for inquiry and reply makes conformance impracticable.

(2) Most Federal Supply Schedule contracts include a provision requiring contractors to reply to agency requests for earlier delivery within three working days, such replies to be made by the same method of communication used by the ordering agency. This contract provision also provides that earlier deliveries offered by contractors and accepted by ordering agencies will be binding on the contractors. Failure to meet maximum Federal Supply Schedule delivery dates (or dates for faster delivery as agreed to by contractors under contracts containing the above-mentioned provision) will constitute a breach of contract and will be treated in accordance with § 101-26.403.

(3) In applying the procedure covered in § 101-26.401-4(a)(1) where contracts do not include the provision referred to in § 101-26.401-4(a)(2) (generally those contracts entered into prior to fiscal year 1963) and the contractor has affirmed his inability to provide earlier delivery, procurement from other sources for delivery within earlier periods than the maximum specified in the Schedule may be made under the "Emergency and Special Requirements" provision of the Schedule. In such cases, an appropriate record justifying the action should be retained.

(b) *Small requirements.* Federal Supply Schedules stipulate dollar amounts or quantitative values below which agencies are not obligated to submit orders and contractors are not obligated to accept orders. In determining applicability of this exception, all requirements which would normally be included in a single order to a contractor must be considered.

(c) *Abnormal requirements.* Federal Supply Schedules stipulate maximum dollar limitations above which agencies may not submit orders and contractors may not accept orders. The maximum limitation varies between Schedules. The value of a single purchase order, or a series of orders placed within a

short time, may not exceed this maximum. Each Schedule also contains instructions with respect to methods of procuring abnormal requirements from sources other than the Federal Supply Schedule contract involved.

(d) *Legislative and judicial agencies.* Except as may be provided by law or by authorized agreement with responsible officials of any agency in the legislative or judicial branches of the Federal Government, no Federal Supply Schedule will include any such agency as subject to its mandatory use provisions.

(e) *Geographic location.* Federal Supply Schedules delineate geographic coverage on a national, zone, regional, or other area basis. In determining exceptions on this basis, the location of the activity to which delivery of the articles will be made or the location at which service will be performed governs, and not the location of the agency office which places the order with the contractor.

(f) *Public exigency.* Federal Supply Schedule contracts permit purchase elsewhere, where necessary, in cases of public exigency. Justification in these cases are subject to review by the General Accounting Office. There is no requirement to contact the applicable Federal Supply Schedule contractor in cases of true public exigency prior to purchase elsewhere; however, agency ordering personnel should be alert to situations where proximity of the contractor's production and distribution facilities to agency point of use result in the contractor's facility being an immediate source of supply to meet the exigency.

(g) [Deleted]

§ 101-26.401-5 Optional use provisions.

(a) Each Federal Supply Schedule contains provisions whereby, in addition to the agencies included under the mandatory use provisions, all agencies and activities of the Federal Government, including the legislative and judicial branches, and other activities for which GSA is authorized by law to procure, may place orders under the Schedule and contractors may accept such orders. This includes those contractors who have been properly authorized, pursuant to Subpart

SUBPART 101-26.4 PURCHASE OF ITEMS FROM FEDERAL SUPPLY SCHEDULE CONTRACTS

101-26.402-2(b)

1-5.9, to use the Federal Supply Schedules. (Also see § 101-26.407.) When a contractor accepts an order tendered under the optional use provision either by written notice, constructive delivery or performance, or failure to return the order within the specified time (usually 3 days after receipt), all provisions of the contract apply with respect to such order.

(b) Agencies not subject to the mandatory use provisions of Federal Supply Schedules are encouraged to use the Schedule contracts as primary sources of supply except in cases where purchasing activities of such agencies have actual knowledge that the purchase can be made more advantageously to the Government from a source other than the Federal Supply Schedule, after allowing for the burdens and cost of a new procurement under applicable prescribed procedures. Purchasing activities should not solicit bids, proposals, quotations, or otherwise test the market solely for the purpose of a comparison of the Federal Supply Schedule prices. Where a procurement from a source of supply other than a Federal Supply Schedule available for optional use indicates that such source might be more advantageous to the Government, as a general source, the name and address of the supplier together with other details of the procurement action should be forwarded to the GSA office issuing the Schedule.

(c) When an executive agency determines that one or more optional use Schedules are suitable for use by the agency as primary sources of supply, the following action should be taken:

(1) Issue administrative regulations instructing its purchasing activities to use the designated Schedules as primary sources of supply subject to any appropriate exceptions that the agency may prescribe in consonance with § 101-26.401-3 and § 101-26.401-4. Copies of such regulations should be furnished to GSA.

(2) Notify the GSA office issuing the Schedule in order that coordinated arrangements may be developed for inclusion of the agency under the mandatory coverage of future reissuances of the Schedule; thus broadening the area of assured agency participation that can be offered prospective contractors to the end that lower prices, earlier deliveries,

and better continuity of supply will result.

§ 101-26.402 General.

§ 101-26.402-1 Schedule method of contracting.

(a) The Schedule method of contracting is used, in the best interest of the Government, to simplify the purchase processes for commonly used items which are readily available through the distribution systems of the respective industries without the necessity of definite quantity consolidated buying or handling through a Government warehouse system. Federal Supply Schedule contracts are entered into and Schedules thereof are prepared and issued by, or under assignment from, GSA on a national, zone, regional, or other area basis, and are supervised by or under the general direction of GSA.

(b) When a Federal Supply Schedule is assigned to another executive agency for preparation and issue, appropriate notification of the assignment will be given to all agencies. Accordingly, the term "GSA office issuing the Schedule" or similar terminology as used in this Subpart 101-26.4 shall be deemed to include the office of another executive agency identified in the Schedule involved as the preparing office.

§ 101-26.402-2 Service features.

(a) Federal Supply Schedules are published in catalog style and list under major commodity classifications the articles or services available from the contractors named therein. Some Schedules involve the use of the contractors' catalogs and pricelists and specify the extent to which such catalogs and pricelists are applicable. Notices of changes in Schedules and in the applicability of catalogs and pricelists are furnished all agency offices receiving the Schedule.

(b) Federal Supply Schedules specify that agencies of the Federal Government must or may, as applicable, issue purchase orders direct to contractors listed in the Schedule; receive and inspect the shipment; and make payment direct to such contractors without referring the transaction to GSA. The contracts provide for appropriate action in the event of delinquency or default on the part of any contractor.

PART 101-26 PROCUREMENT SOURCES AND PROGRAMS

101-26.402-3

§ 101-26.402-3 Distribution.

(a) Agency offices desiring to receive current copies and to be placed on distribution lists for receiving Federal Supply Schedules and contractors' catalogs should execute and submit GSA Form 457, Request for Federal Supply Schedules and Contractors' Catalogs (Including Pricelists) (see § 101-26.4902-457). Copies of GSA Form 457 may be obtained from GSA regional offices and are included annually in issues of the Federal Supply Schedule Checklist and Guide.

(b) From time to time, GSA regional offices will request information from agency offices in their respective areas for use in maintaining up-to-date distribution lists.

§ 101-26.402-4 Checklist and Guide.

The Federal Supply Schedule Checklist and Guide, issued quarterly, contains a listing of all current Schedules and information pertinent thereto, together with the distribution code number for each Schedule and catalog. Accordingly, agency offices should consult the latest edition of the Checklist and Guide before submitting requests for Schedules and catalogs as provided in § 101-26.402-3.

§ 101-26.402-5 Contract provisions.

(a) Each Federal Supply Schedule provides information as to the contractual provisions with which agencies should be familiar in order to properly administer orders placed with contractors.

(b) Standard Form 32, General Provisions (Supply Contract) (§ 1-16.901-32), is progressively being incorporated in Federal Supply Schedule contracts thus promoting uniformity of understanding and ease of reference on the part of agency procurement personnel. Additional general provisions that have been standardized by GSA for use in all Federal Supply Schedule contracts are incorporated in the Federal Supply Schedule Checklist and Guide. A "Scope of Contract" statement (see § 101-26.401-3), special provisions pertinent to a particular Schedule, and any necessary exceptions to the general provisions are printed in the Schedule.

§ 101-26.403 Performance and default under Federal Supply Schedule contracts.

§ 101-26.403-1 Responsibilities.

While GSA awards Federal Supply Schedule contracts and exercises general supervision over such contracts, it is the responsibility of agencies whose requirements are included in the contracts to place orders with contractors, make payment, and, in the first instance, determine whether performance meets the contract terms. Agencies whose orders are accepted by the contractor pursuant to the optional use provision have like responsibilities. Subject to the provisions of the contracts and the conditions stated in this Subpart 101-26.4, ordering offices should deal directly with contractors concerning their performance of the contract terms, and should accept or reject the supplies or services, make price adjustments for nonconforming supplies or services, or seek replacements, and, in case of default, terminate purchase orders, purchase from other sources, and charge contractors with resulting excess costs. In certain instances, Federal Supply Schedule contracts will provide for inspection at source, prior to shipment, by GSA. When the Federal Supply Schedule states that source inspection will be provided by GSA, ordering offices are relieved of dealing directly with contractors concerning specification compliance and acceptance or rejection of the supplies or services.

§ 101-26.403-2 Inspection.

(a) *Acceptance inspection.* (1) Acceptance inspection of supplies and services is necessary to assure compliance with the applicable specifications and other contractual requirements. Unless a particular Federal Supply Schedule specifically provides for source inspection by GSA, arrangements for inspection shall be the responsibility of the ordering agency. When assistance in inspection is desired, or the Federal Supply Schedule provides for source inspection by GSA, the ordering agency shall furnish two copies of the purchase order to the Chief, Quality Control Division, Federal Supply Service, at the GSA regional office serving the area where the plant is located or from which shipments are made. The purchase order shall indicate that inspection shall be performed at source, prior to shipment, by the Quality Control Division of the appro-

SUBPART 101-26.4 PURCHASE OF ITEMS FROM FEDERAL SUPPLY SCHEDULE CONTRACTS

101-26.403-5

appropriate GSA regional office. In determining the need for assistance in inspection, when a Federal Supply Schedule does not provide for source inspection, the ordering agency shall consider the volume of the procurement, complexity of the items, and the past performance of the supplier.

(2) A copy of the GSA Form 308, Notice of Inspection, executed by the GSA Quality Control representative, will inform other than military consignees of acceptance and/or rejection determination. DD Form 250, Department of Defense Materiel Inspection and Receiving Report, will be used to inform military consignees of acceptance determination, and GSA Form 308, Notice of Inspection, will be used to inform the military consignees of rejection determination.

(3) Material which has been inspected by GSA and determined to be in compliance with specifications and technical contract requirements (quality inspection) shall not be reinspected by another agency for that purpose. Examination of delivery shall be limited to determination of quantity and condition upon receipt by consignee.

(b) *Nonconforming supplies or services.* (1) The ordering agency shall report to the GSA office executing the contract all significant instances where nonconforming supplies and services are received. Ordering officers have the right either to reject supplies defective in material or workmanship, or otherwise not in conformity with contract requirements, or to require their removal for correction or correction in place, by and at the expense of the contractor. Ordering offices may accept nonconforming supplies and services, and pay therefor at a proper reduction in price in accordance with the contract provisions, or may terminate the right of the contractor to proceed further under the purchase order. Unless the contractor corrects or replaces supplies within the delivery schedule, the ordering office may declare the contractor in default and purchase the supplies elsewhere against the contractor's account.

(2) When supplies have been inspected and rejected at source by GSA and replacement or correction will not be made by the contractor, the notice of rejection will so inform the ordering agency.

The notice will contain appropriate recommendations regarding acceptance at a proper reduction in price or termination of the contractor's right to proceed and purchase elsewhere in accordance with § 101-26.403-5.

§ 101-26.403-3 Delinquent performance.

Where the contractor fails to perform in accordance with the provisions of the contract, ordering offices may afford a further opportunity to perform or terminate the right of the contractor to proceed further under the purchase order, declare the contractor in default on the order, and purchase elsewhere against his account. Should the contractor allege that the failure in performance was due to an excusable cause precluding assessment of excess costs under the provisions of the contract, the GSA office executing the Schedule contract shall be notified promptly. In the absence of a decision by the contracting officer executing the contract, or by the Administrator, or his duly authorized representative, on appeal, pursuant to such notice that the failure is excusable, the ordering office is free to charge against the contractor any excess cost resulting from the default. When the ordering office is aware that the defaulting contractor has alleged the failure to be excusable, it may elect to postpone the assessment of excess costs until a decision is made in order to avoid unnecessary accounting actions.

§ 101-26.403-4 Disputes.

All disputes concerning questions of fact arising under the contract which cannot be settled satisfactorily between the ordering office and the contractor shall be decided by the GSA contracting officer or by the Administrator, or his duly authorized representative, on appeal.

§ 101-26.403-5 Default; ordering office.

Any ordering office may, in respect to any one or more purchase orders placed by it under a contract, declare the contractor in default in accordance with the applicable contract provisions. However, before declaring a contractor in default, it is suggested that ordering offices should ordinarily notify the con-

PART 101-26 PROCUREMENT SOURCES AND PROGRAMS

101-26, 403-5

tractor in writing that unless satisfactory performance occurs within a specified time, which should allow a reasonable time for performance, the ordering office will terminate his right to proceed further under the purchase order and he will be held liable for any excess costs resulting from purchasing the supplies or services elsewhere. Such notice would not ordinarily be given when the default involves an attempted fraud on the United States, or when it would be obviously futile as, for example, when the contractor has already declined to perform. Where excess costs are anticipated, the ordering office may likewise withhold sufficient funds otherwise due the contractor as offset security. Ordering offices shall endeavor to minimize excess costs to be charged against the contractor and to collect by check or set off any excess costs owed (see § 1-8.602-6). The GSA office executing the contract shall be notified of all cases where an ordering office has declared a Federal Supply Schedule contractor in default.

§ 101-26.403-6 Default; GSA.

GSA may declare a contractor in default on an overall basis for any or all items covered by the contract, in accordance with the applicable contract provisions, as distinguished from ordering office action on individual orders. When notified of such action by GSA, ordering offices shall thereafter refuse to accept further performance by the contractor, shall not place further purchase orders with him, and shall purchase against the account of the contractor from replacing contractors designated by GSA, or in such other manner as directed by GSA.

§ 101-26.403-7 Failure to collect excess costs.

Ordering offices shall report to the GSA office executing the Federal Supply Schedule contract involved those instances where they have been unsuccessful in collecting excess costs which have accrued against a defaulting contractor. Reports shall be made within sixty days from date of final payment to the new contractor from whom the replacement purchase was made and may be in letter form. Such reports shall provide complete information so as to identify properly the transaction and furnish necessary data, such as the name of the

defaulting contractor, contract number, item number and description, Schedule price, and the amount of excess costs to be collected. In addition, complete information shall be reported concerning the supplier from whom substitute purchase was made, such as the name of the supplier, purchase price, order number or numbers on which payment was made, and contract number, if any. The GSA office will consolidate such data as reported and, in the absence of an available offset in that office, will submit such data through channels to the General Accounting Office for collection.

§ 101-26.404 Submission of requirements of gasoline, fuel oil (diesel and burner), kerosene, and solvents.

§ 101-26.404-1 General.

(a) Requirements of all executive agencies, except the Department of Defense, for the items described in § 101-26.404-2, exclusive of liquid fuels for marine use and burner fuel oil obtained from or through the GSA Fuel Yards in Washington, D.C., to be delivered within the continental United States (excluding Alaska), shall be submitted to GSA in order to enter into Federal Supply Schedule contracts for such items. Requirements for liquid fuels for marine use by all Federal agencies will be submitted to the Defense Fuels Supply Center, Washington, D.C., 20305, in accordance with instructions of that office. Estimates of requirements should be based on previous records of consumption whenever available. In the case of new delivery points, consumption records of similar installations may be used as guides. Any other Federal agency may also submit its requirements for the items covered by § 101-26.404-2 and such requirements will be included in the solicitation of bids and the resulting contracts. Use of Federal Supply Schedule contracts entered into on the basis of requirements submitted shall be mandatory for the consignees covered in the contracts.

(b) Federal Supply Schedules for the items in § 101-26.404-2 are intended to cover agency requirements for bulk deliveries only. Requirements normally filled by service station deliveries will not be included. (See § 101-26.404-3.)

SUBPART 101-26.4 PURCHASE OF ITEMS FROM FEDERAL SUPPLY SCHEDULE CONTRACTS

101-26.405 (a)

§ 101-26.404-2 Items covered.

(a) *Gasoline*—(1) *Regular and premium*. In accordance with the latest issue of the applicable Federal Specification.

(2) *Unleaded*. In accordance with the latest issue of the applicable Federal Specification.

(b) *Fuel oil, burner*. (1) Grades 1, 2, 4, 5 (light), 5 (heavy), and 6 in accordance with the latest issue of the applicable Federal Specification.

(2) Fuel oils meeting requirements of Pacific Specifications, as published in Bulletin entitled "Fuel Oils (First Edition) Recorded Standard Designations for Pacific Coast Fuel Oils," will be accepted for requirements in the States of Arizona, California, Nevada, Oregon, and Washington in lieu of Federal Grades 1, 2, 4, 5 (light), 5 (heavy), and 6 on the following basis:

(i) Fuel oils meeting Pacific Specification 100 will be accepted for Federal Grade 1.

(ii) Fuel oil meeting Pacific Specification 200 will be accepted for Federal Grade 2.

(iii) Fuel oil meeting Pacific Specification 300 will be accepted for Federal Grades 4 and 5.

(iv) Fuel oil meeting Pacific Specification 400, and also having a viscosity not exceeding 300 seconds Furol at 122° F., will be accepted for Federal Grade 6.

(c) *Fuel oil, diesel*. In accordance with the latest issue of the applicable Federal Specification.

(d) *Kerosene*. In accordance with the latest issue of the applicable Federal Specification.

(e) *Solvents*. In accordance with the latest issue of the applicable Federal Specification.

§ 101-26.404-3 Minimum quantities.

(a) *Single delivery*. The following will be the minimum quantities furnished to any one point on a single delivery:

<i>Delivered in</i>	<i>Minimum quantity</i>
Drum-----	4 drums (200-220 gallons).
Tank wagon-----	200 gallons.
Transport truck---	Full truckload (4,000-7,500 gallons).
Tank car-----	Full carload (8,000-12,000 gallons).

(b) *Estimated annual requirements*. Estimated annual requirements for any

delivery point which total less than the following minimums shall not be submitted:

- (1) Gasoline, 2,000 gallons.
- (2) Burner fuel oil, 2,000 gallons.
- (3) Diesel oil, 2,000 gallons.
- (4) Kerosene, 500 gallons.
- (5) Solvents, 500 gallons.

§ 101-26.404-4 Instructions for submission of requirements.

(a) Estimates shall be prepared and submitted on the following forms:

(1) GSA Form 211, Estimated Gasoline Requirements (see § 101-26.4902-211); GSA Form 212, Estimated Kerosene and Fuel Oil Requirements (see § 101-26.4902-212); and GSA Form 213, Estimated Solvent Requirements (see § 101-26.4902-213).

(2) A separate requirement form shall be submitted, in original only, for each delivery point.

(b) Contracts will be established by each GSA regional office for requirements to be delivered within its area of supply support. The requirement forms shall be submitted to the GSA regional office serving the area in which the delivery point is located. Each GSA regional office will provide agencies in its area additional instructions for submission of requirements, including deadline dates for receipt thereof.

(c) In the event that annual estimated requirements of specified delivery points are the same as submitted for the previous year, a statement to that effect will suffice. Unless other acceptable arrangements have been made with the GSA regional office concerned, such statement shall list all delivery points whose requirements are unchanged.

§ 101-26.405 Automatic data processing equipment.

(a) Federal Supply Schedule contracts are entered into for the rental, purchase, and maintenance of automatic data processing (ADP) equipment and components. These are negotiated, multiple award contracts. The contracts take into account the multiplicity and complexity of equipment of various manufacturers and the differences in performance required to accomplish or produce required end results. They are designed to provide agencies a wide selection of

PART 101-26 PROCUREMENT SOURCES AND PROGRAMS

101-26.405 (a)

equipment and services to meet their particular needs.

(b) Policies on selection and acquisition of ADP equipment are contained in Bureau of the Budget Circular No. A-54.

(c) Ordering agencies shall carefully follow the terms and conditions of the appropriate contract as set forth in the Federal Supply Schedule and authorized contractors' pricelists in order to take full advantage of the benefits they provide. Such terms and conditions cover, for example, rental based on machine "use" rather than on machine "availability," requirement that equipment actually perform the programmed work for a thirty-day period before any rental is paid, liquidated damages provision applicable if contractor fails either to install the equipment by the specified installation date or to deliver programming aids by the agreed-upon date, time period for notifying a contractor of the discontinuance of a system or an individual machine, rental charges during period of conversion from a machine or system of a particular contractor to another machine or system of the same contractor, and the amount of program testing to be performed.

(d) When arrangements differing from those covered by the Federal Supply Schedule contracts, such as purchasing equipment by competitive bid or competitive negotiation (where adequate specifications can be developed) or renting from equipment leasing companies, can be made by agencies for a portion or all of their ADP equipment requirements at a lower overall cost than provided by the Schedule contracts, advantage should be taken of those special arrangements, coordinating in advance with GSA in the contracting for the requirements.

§ 101-26.406 U.S. Government National Credit Card for use in obtaining service station deliveries and services.

§ 101-26.406-1 General.

Standard Form 149, U.S. Government National Credit Card (see § 101-38.801-2), is authorized for use by Federal agencies for obtaining authorized services and delivery of supplies at service stations dispensing supplies of the contractors listed in Federal Supply Schedule FSC Group 91, Part III.

§ 101-26.406-2 Billing code.

The billing code is a 10-digit number and always is the first embossed line on the Standard Form 149. Nine of the digits are assigned by the using agency in accordance with the following instructions:

(a) The first three digits of the billing code will always be 000 or 002. The digits 002 are special account numbers and may not be used unless authorized by General Services Administration, Federal Supply Service, Procurement Operations Division, Washington, D.C., 20407. These digits signify to the contractors that a Federal contract is involved.

(b) The fourth digit may be used by the agency to designate the vehicle class or for other purposes to meet the agency's requirements. If not used for any such purpose, the fourth digit will be zero.

(c) The fifth and sixth digits will be the Agency Code; except where the first four digits have been assigned to designate the agency, in which case the agency may use the fifth and sixth digits for any purpose desired. Agency codes are shown in Treasury Department booklet "Receipt, Appropriation, and Other Fund Account Symbols and Titles."

(d) The seventh, eighth, and ninth digits indicate the agency billing address code number; except where the first four digits cover the agency, in which case the agency may use the seventh, eighth, and ninth digits for any purpose desired. Each Federal agency will assign its own billing address code numbers when the seventh, eighth, and ninth digits are used for such purpose.

(e) The tenth digit is the reject number for use in automatic billing operations of the contractors. This number is not assigned by the agency but will be determined by the Federal Supply Schedule, FSC Group 75, Part VII, embossing contractor, or by the GSA regional office embossing the card.

§ 101-26.406-3 Billing address.

The billing address is the name of the agency and the address to which contractors should send statements covering the purchases of supplies and services by the user of the Standard Form 149, U.S. Government National Credit Card. The number of lines in the billing address is limited to three, and shall al-

SUBPART 101-26.4 PURCHASE OF ITEMS FROM FEDERAL SUPPLY SCHEDULE CONTRACTS

101-26.407-1 (b)

ways be the second, third, and fourth embossed lines.

§ 101-26.406-4 Tag or registration number.

The tag or registration number of the vehicle for which the credit card is issued is always the fifth embossed line. A credit card may be used only for supplies or services for the vehicle bearing the tag or registration number embossed thereon.

§ 101-26.406-5 Methods of obtaining Standard Form 149: U.S. Government National Credit Card.

(a) *Orders for 50 or more.* (1) Agency purchase orders for 50 or more of embossed Standard Form 149 shall be forwarded to the embossing contractor as provided in Federal Supply Schedule, FSC Group 75, Part VII.

(2) The embossing contractor will bill ordering agencies directly.

(b) *Requisition for 49 or less.* (1) Agency requisitions for 49 or less of embossed Standard Form 149 shall be forwarded to the Chief, Motor Equipment Division, at the nearest GSA regional office.

(2) Each agency shall furnish the billing code, the billing address, and the tag or registration number for each Standard Form 149 requisitioned. Such information shall accompany the requisition and shall be limited to five lines with twenty-two characters (including spaces) per line.

(3) GSA will bill requisitioning agencies or will accept cash payment.

§ 101-26.406-6 Notice to GSA of assignment of billing codes and billing addresses.

(a) Agencies shall notify GSA of assignment of Standard Form 149 billing codes and billing addresses. Such notices shall be submitted to: General Services Administration, Federal Supply Service, Procurement Operations Division, Washington, D.C., 20407. In the interest of uniformity, it is requested that agencies, in submitting notices, use the following format:

To: General Services Administration
Federal Supply Service
Procurement Operations Division
Washington, D.C. 20407

(Agency, Bureau, Service, or Other Purchasing Activity) has assigned the billing

code(s) and billing address(es) as listed below, or attached hereto, to Standard Form 149.

000 147 201
GSA DIR REG FM MP
30 Church Street
New York, N.Y. 10007

Contracting Officer.

NOTE: Tag or Registration Number is NOT required.

(b) Once GSA has been officially notified of the assignment of billing codes and billing addresses, the agency may order additional Standard Forms 149 using the same billing code and billing address for additional tag numbers without reporting such use. Changes in billing codes and billing addresses must be furnished GSA so that the contractors furnishing supplies and services may be informed. This is essential for proper control of billing procedures.

§ 101-26.406-7 Government Printing Office waiver.

A waiver has been issued by the Government Printing Office to GSA for the procurement of the printing of the Standard Form 149.

§ 101-26.407 Procurement of security cabinets by Government fixed-price prime contractors.

§ 101-26.407-1 General.

(a) Based on recommendations of the Interdepartmental Committee on Internal Security, it has been determined essential that security cabinets be made available for purchase under Federal Supply Schedule contracts by all Government contractors and subcontractors (at any tier) who are required to maintain custody of security classified records and information under any type of contract or subcontract.

(b) In accordance with section 201 of the Federal Property and Administrative Services Act of 1949 (40 U.S.C. 481), the Administrator of General Services has determined that the purchase of security cabinets under Federal Supply Schedule contracts by Government prime contractors and their subcontractors for the protection of security classified information represents procurement for the "use of executive agencies" under the statute.

PART 101-26 PROCUREMENT SOURCES AND PROGRAMS

101-26.407-2

§ 101-26.407-2 Applicability.

The provisions of this § 101-26.407 apply only to the purchase of security cabinets under Federal Supply Schedule contracts by fixed-price prime contractors and by first and lower tier subcontractors under any type of contract. They do not apply to the purchase of security cabinets under Federal Supply Schedule contracts by cost-type prime contractors. Such purchases are subject to the requirements of Subpart 1-5.9.

§ 101-26.407-3 Procedure for ordering security cabinets.

(a) Cognizant contracting agencies will arrange to notify their prime contractors and subcontractors who require such cabinets for the protection of security classified information that, subject to the conditions described in § 101-26.407-3 (b) and (c) and in accordance with procedures included in Federal Supply Schedules, they may purchase such cabinets under the applicable Federal Supply Schedule contracts.

(b) Purchases of security cabinets under Federal Supply Schedule contracts by fixed-price prime contractors and subcontractors under either fixed-price or cost-type prime contracts may be made only after written authorization therefor is obtained from the agency having cognizance of the prime contract involved; and the authorization (or a true copy) must be furnished to the Federal Supply Schedule supplier in connection with the placement of orders for such cabinets.

(c) A statement substantially as follows should be placed on orders for security cabinets placed with Federal Supply Schedule contractors:

In the event of any inconsistency between the terms and conditions of this order and those of your Federal Supply Schedule contract, the latter will govern.

§ 101-26.407-4 Use and disposal of security cabinets.

Security cabinets purchased in accordance with this § 101-26.407 shall be used as prescribed by the cognizant contracting agency and may not be disposed of without its express approval.

§ 101-26.408 Price reductions during contract period.

(a) Each Federal Supply Schedule contract involving multiple awards contains a clause entitled "Price Reductions to a Federal Agency." The clause provides that if, during the life of the contract, any Federal agency cites that contract as the contract under which its order is placed and the contractor sells to that agency at reduced price any article or service covered by the contract and the quantity involved falls within the applicable maximum order limitation set forth in the contract, equivalent price reductions based on similar quantities and/or considerations shall apply to his Federal Supply Schedule contract and, thereafter for the duration of the contract period, the contractor shall invoice all ordering offices at such reduced price.

(b) Each Federal agency which has made a purchase of the type covered by the "Price Reductions to a Federal Agency" clause shall, within ten days, notify the contracting officer of such purchase.

§ 101-26.409 Multiple-award contracts.

§ 101-26.409-1 Description.

(a) Multiple-award Federal Supply Schedules cover contracts made with more than one supplier for comparable items at either the same or different prices for delivery to the same geographical area. These schedules are identified by the inclusion, in the Special Provisions, of a paragraph entitled "Multiple Awards."

(b) Federal Supply Schedule contracts are made on a multiple award basis when one or both of the following circumstances apply:

(1) The most effective utilization of industry production and distribution facilities in meeting the needs of the Government can be accomplished through making multiple awards and such awards are otherwise advantageous to the Government. (Considerations in determining that multiple awards should be made include price, quality, facility of delivery, availability of production and distribution facilities, technical advice or service in connection with products involved, and other pertinent factors.)