

REQUEST FOR RECORDS DISPOSITION AUTHORITY

(See Instructions on reverse)

LEAVE BLANK

JOB NO

NI-25788-1

DATE RECEIVED

3/9/88

TO **GENERAL SERVICES ADMINISTRATION
NATIONAL ARCHIVES AND RECORDS SERVICE, WASHINGTON, DC 20408**

1 FROM (Agency or establishment)

Department of Labor

2 MAJOR SUBDIVISION

Bureau of Labor Statistics

3 MINOR SUBDIVISION

Offices Listed Below

4 NAME OF PERSON WITH WHOM TO CONFER

Karen Nunley

5 TELEPHONE EXT

523-1468

DATE

7/27/90

ARCHIVIST OF THE UNITED STATES

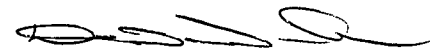

6 CERTIFICATE OF AGENCY REPRESENTATIVE

I hereby certify that I am authorized to act for this agency in matters pertaining to the disposal of the agency's records, that the records proposed for disposal in this Request of _____ page(s) are not now needed for the business of this agency or will not be needed after the retention periods specified, and that written concurrence from the General Accounting Office, if required under the provisions of Title 8 of the GAO Manual for Guidance of Federal Agencies, is attached

A GAO concurrence is attached, or is unnecessary
x is pending

B DATE

12 FEB 88

C SIGNATURE OF AGENCY REPRESENTATIVE

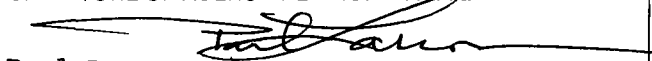

D TITLE

DOL Records Officer

7
ITEM
NO

8 DESCRIPTION OF ITEM
(With Inclusive Dates or Retention Periods)

9 GRS OR
SUPERSEDED
JOB
CITATION

10 ACTION
TAKEN
*(NARS USE
ONLY)*

Records pertaining to the following offices:

- o Offices of the Commissioner
- o Offices of Field Operations
- o Office of Productivity and Technology
- o Office of Survey Processing
- o Office of Administration
- o Office of Technology and Operations Review
- o Office of Publications
- o Office of Research and Evaluation

All changes to this proposed schedule have been approved by:

C. Jean Sadlock
NARA appraiser

7/5/90
date

Karen A. Nunley
Agency representative

6-7-90
date

Copies sent to agency, NCF, HND, MT, NNS, NMX 7/31/90

TABLE OF CONTENTS

	<u>PAGE</u>
INSTRUCTIONS FOR APPLYING THE BLS RECORDS DISPOSITION SCHEDULE.....	i
AUTHORITY AND ADMINISTRATIVE HISTORY.....	xv
BINDER OF SCHEDULE.....	xix
EXPLANATORY STATEMENTS.....	xx
IMMEDIATE OFFICE OF THE COMMISSIONER FOR THE BUREAU OF LABOR STATISTICS.....	1
OFFICE OF THE COMMISSIONER MANAGEMENT INFORMATION STAFF.....	9
OFFICE OF FIELD OPERATIONS.....	14
Administrative Staff.....	20
Forms Design Unit.....	27
Program Related Training Branch.....	29
OFFICE OF PRODUCTIVITY AND TECHNOLOGY DIVISION OF INTERNATIONAL TRAINING.....	37
OFFICE OF SURVEY PROCESSING OFFICE OF THE ASSISTANT COMMISSIONER.....	47
OFFICE OF ADMINISTRATION.....	49
Division of Personnel and Organization Management.....	52
Division of Financial Planning and Management Overview of Division Mission, Functions, and Organization.....	62
Division of Administrative Services.....	70
Division of Management Systems.....	77

TABLE OF CONTENTS - 2

PAGE

OFFICE OF TECHNOLOGY AND OPERATIONS REVIEW.....	80
Division of Automatic Data Processing Support.....	82
Division of Communications and Computer Technology.....	84
Division of System Design.....	86
Division of Management Information Systems.....	89
OFFICE OF PUBLICATIONS.....	92
Division of Information Services.....	97
Division of Production Services.....	100
Division of Editorial Services.....	109
OFFICE OF RESEARCH AND EVALUATION.....	113
GRS 20 Excerpts.....	123
Permanent Records Listing.....	127

Note: An asterisk () has been placed in front of the item numbers of files described in the schedule which could lead to the pin pointing of individual establishments and could thus be considered confidential. In some instances only segments of the total file described as an item would be involved.

**INSTRUCTIONS FOR APPLYING THE BLS
RECORDS DISPOSITION SCHEDULE**

I. GENERAL

A. Background and Scope.

This Schedule is the sole authority in the BLS offices covered controlling the preservation and disposal of BLS records. Its provisions have been concurred in by the General Accounting Office and approved by the Archivist of the United States. It complies with all laws and regulations governing the disposition of records. It replaces the previous Schedule for BLS approved in 1971.

1. Survey of Records. During the records survey, upon which this Schedule is based, an effort was made to examine each file in the Headquarters Offices of the offices covered. The wording of the description of each file included and of the retention period assigned to each file was developed with and approved by the operating official having the primary interest in the records.
2. Economies Through Application. The Schedule provides all operating officials with continuous authority to transfer or dispose of papers in accordance with the retention period prescribed for each file. It should enable most offices to conduct their current business with a reduced volume of files held in their space.
3. Retention Periods Included. The retention period stated for the items of the Schedule are mandatory. This means that they provide for a minimum time period after which records can be destroyed, but not sooner.

The Schedule has two types of retention periods for records of temporary value, depending on the type of records concerned-- those with a fixed period of time, and those dependent on completion of a certain conditions. An example of the fixed type of retention period would be "Destroy after five years." An example of the conditional type would be, "Destroy after all essential information has been tabulated or published."

It is possible to retain records longer than the fixed time periods stated in the Schedule but only if an adequate justification for such an extension can be made. If the proposed extension involves a lengthy period of time and/or a significant volume of records, the official responsible for the records should contact the BLS Records Management Officer. The Records Management Officer will take the necessary steps to attempt to obtain approval for the extension of the retention period from the National Archives and Records Administration as required by the Federal Property Management Regulations (36 CFR 1228.72).

4. **Non-Record Materials.** Non-record materials comprise those recorded materials which under law (44 USC 3301) can be disposed of in offices without authorization from the National Archives and Records Schedule. Their disposal is at the option of the office concerned after their usefulness is exhausted.

Examples of non-record materials include:

- ° Extra copies of documents preserved only for convenience of reference. This group includes "reading file" copies, or "tickler" or "follow-up" copies, if their use is temporary.
- ° Carbons or quick copies of informational memoranda and incoming transmittal letters which do not affect or aid in determining the action to be taken on the documents transmitted.
- ° Preliminary drafts or work sheets that do not represent significant steps in the preparation of other documents.
- ° Stock of blank forms, publications, and processed documents.
- ° Surplus copies of mimeographed, multilited, dittoed, printed, or processed circulars, memoranda, or forms.
- ° Shorthand and other notes, tapes, disks, and dictation records that have been transcribed.
- ° Library and museum material made or acquired and preserved solely for reference or exhibition purposes.
- ° Memoranda or other papers that do not serve as the basis of official action; for example, charity appeals and notices of activities of Government associations or unions.

B. **Yearly Application of the Schedule.**

The key to removing inactive records from expensive office space is to apply the approved BLS Records Disposition Schedule systematically and continually in all offices which it covers. As a minimum, each official responsible for records should apply the retention periods of the Schedule to the records of the office concerned at least once a year, preferably during the same month each year. The Schedule should be applied more often than once a year to those records having a Schedule retention period of less than a year.

C. **Methods of Applying the Schedule.**

1. **Destroy Records in Offices.** Many of the BLS records are not very voluminous or are short-lived enough that they may be maintained in office space until their retention periods have lapsed, and they can be destroyed in offices as trash. The Schedule retention period for these types of records will indicate to destroy them after a time period.

2. Transfer to the Suitland, Maryland Records Center. Certain BLS records are voluminous and must be retained for long periods of time. The retention period on the Schedule for this type of record will indicate to retain in the office for a time period and then transfer to the Washington National Records Center at Suitland (WNRC) where the records will be destroyed after BLS approval has been obtained.

BLS no longer has a central on-site records holding area in its headquarters offices for the temporary storage of such types of records. Certain offices, however, do have small on-site storage facilities for temporary records storage.

3. Transfer to the Archives of the United States. A few collections of records are considered to be of permanent value and historical interest and necessary to document the activities of the BLS. The retention periods on the Schedule for this type of record will indicate that records are permanent and to be transferred to the Archives of the United States at agreed-upon time periods.
4. Microfilm to Reduce Records Volume. Certain types of machine-readable records, as indicated on the Schedule, are being microfilmed by Computer Output Microfilmers. Microfilming reduces the amount of potentially voluminous paper records to permit these records to be economically retained in office space for long time periods before removal.

D. Distribution of the Schedule.

This Schedule is being stocked by the BLS Records Management Officer, and its distribution will be controlled by that official. Copies will be distributed to appropriate officials or recordkeepers as required in the offices covered. Revised or new pages resulting from Schedule changes will be distributed to holders of the Schedule together with appropriate instructions for insertion into the Schedule. To facilitate the filing of needed revisions, the Schedule is being issued in loose-leaf format.

II. FINDING YOUR OFFICE SEGMENT OF THE SCHEDULE

The Schedule is arranged organizationally. The table of contents in front of the Schedule lists the page numbers for each of the Divisions or other organizational units covered. Before trying to apply the Schedule, be sure to check the table of contents and then look through the particular items of the Schedule covering your office records. If you have trouble finding an item that covers certain of the records in your office, contact the BLS Records Management Office on 523-1468 for help.

III. DISPOSAL (DESTRUCTION) OF TEMPORARY RECORDS FOR WHICH THE RETENTION PERIODS OF THE SCHEDULE HAVE LAPSED.

A. Records in Office Space or Office Storage Facilities.

At the time the Schedule is applied in an office, it is the responsibility of the official in charge to determine which of the temporary records of the office are ready for disposal because the retention periods of the Schedule covering those records have lapsed. Recordkeepers should bring the existence of such records to the attention of the official in charge.

1. Obsolete Paper (Hard-Copy) Records.

a. Unrestricted Records.

If the obsolete paper records do not contain information, the release of which would violate the pledge of confidentiality given to Bureau reporters and the volume is small, they should be placed in wastebaskets. If the volume is large, they should be placed in containers marked "TRASH," and put in the hall for regular trash pick-up.

b. Confidential Records

If the records contain information, the release of which would violate the Bureau's pledge of confidentiality to its reporters, they should be placed in containers and taken to the appropriate shredding machine for destruction. Contact the Bureau Records Management Officer on 523-1468 for information as to the location of shredding machines if unknown, or for making other possible arrangements for the safe destruction of these records.

2. Machine-Readable Records. Obsolete information in machine-readable format, after being authorized for disposal by the Schedule and the appropriate official, is scratched by the computer facility to permit reuse of the magnetic tapes or disk tracks.

3. Volume Data. The following data are helpful in estimating the volume of records disposed or the number of boxes required for Center transfers:

- 1 full legal file cabinet drawer =
2 cubic feet
- 1 full letter file cabinet drawer =
1 1/2 cubic feet
- 1 full shelf file = 3 cubic feet
- 7 magnetic tapes = 1 cubic foot
- 1 Records Center box = 1 cubic foot

B. Disposal of Obsolete Records Stored at WNRC.

Bureau policy requires that obsolete records stored at the Washington National Records Center (WNRC) at Suitland, Maryland cannot be destroyed by Center personnel without the Center first obtaining the written clearance of the appropriate Bureau officials. The Center sends Form 7015, "Notice of Intent to Destroy Records" to the BLS Records Management Officer describing any stored records for which the retention period of the Schedule has lapsed. The BLS Records Officer will contact the appropriate official responsible for the records to obtain the necessary clearance. If the Bureau does not respond within 90 days of the receipt of the Notice, the Center is automatically authorized to dispose of the records in question.

IV. TRANSFER OF HEADQUARTERS OFFICE RECORDS TO THE WASHINGTON NATIONAL RECORDS CENTER (WRNC)

Records transferred to the WNRC remain in the legal custody of the Bureau. The Center, however, will only deal with the Bureau Records Manager's Office regarding stored records, and all matters involving the transfer, retrieval, or disposal of stored records must be cleared with that Office, Room 2051 GAO Building, telephone 523-1468. Further, the Center strictly enforces its regulations regarding what records it will accept for storage, how they will be packed, how they will be described, how they will be retrieved, and how they will be disposed of. To have any records stored in the Center, the BLS Records Manager must comply with all applicable Center regulations.

A. Records Acceptable For Center Transfer.

A clause covering the proposed transfer of inactive records to WNRC has been included in the retention period of the Disposition Schedule for each file which appears to warrant Center storage. Typically, the Center will not accept for storage any records that do not have such a statement in the Schedule retention period. Unless enough paper records are on hand to fill at least one records center box, (one cubic foot), they should not be offered for transfer.

At present, the Center will only accept records that will be stored for at least three years. It will not presently accept the following: (1) non-record materials; (2) records that are not adequately described on approved transfer forms in accordance with the Disposition Schedule; (3) collections that include heavy mixtures of record and non-record materials; (4) any records which have not been included on an approved Disposition Schedule; (5) collections that contain mixtures of records with differing scheduled retention periods in each of the boxes; or (6) any collection of temporary records for which a specific disposal date cannot be set by the agency in accordance with its Schedule.

B. Availability of Approved Records Storage Boxes.

Any records to be stored in WNRC must be packed in approved records storage boxes. Any office wishing to store records in WNRC should contact the Bureau Records Management Office to obtain such boxes.

1. **Storage of Paper Records.** Approved records storage boxes for paper records are unassembled (flat) when they are delivered to the Bureau Records Manager. Typically, the type of box that is available is the "tuck bottom" box that does not require taping to seal the bottom when packed. See Exhibit 1 at the back of these instructions for an illustration covering how to assemble this type of approved box.

Even if an office is planning to store records in available on-site temporary storage, the approved boxes should be used, as such records may later be proposed for transfer to WNRC.

2. **Magnetic Tape Storage.** A special Center box has been designed for the transfer and storage of plastic containers housing magnetic tape. The box holds up to 13 standard 10 1/2-inch reels of magnetic tape in protective plastic containers. Reels should be packed on end, parallel to the front of the box. Fill empty space with cushioning to prevent shifting or crushing. Seal the box with filament tape to keep out dust.

C. Boxing Proposed Paper Records Transfers.

Estimate the number of records storage boxes your office will request from the Bureau Records Manager by referring to the records container volume chart on page iv of this Instruction. When packing paper records in boxes, letter size record folders are placed facing the 12-inch side of the box. Legal size folders face the 14 3/4-inch side of the box. Do not tape the top of the boxes. The flaps need only to be tucked over each other. Each box holds 1 cubic foot of records.

The Center requires that each box be packed to contain records with the same retention period. This rule may cause occasionally a box to be only partially filled. If necessary, place cushioning in these boxes to hold records in place.

D. Describing Records To Be Transferred to Storage from Office Space - General

Any office transferring inactive records either to on-site storage space if available, or to the Washington National Records Center (WRNC) if the Disposition Schedule proposes such a transfer, needs to retain in its office files adequate information describing the transferred records. Without such detailed box-by-box descriptive listings of box contents, an office will not know which records have been stored, or where the stored boxes are located, if the stored records must be found at a later time.

In addition, such box-by-box content listings will be needed by the Bureau Records Management Office when it prepares the SF 135 "Records Transmittal and Receipt" form required for transferring any records to WNRC. The Bureau Records Management Office will send a copy of this form (See Exhibit 2) to the office requesting the transfer to WNRC.

E. Describing Paper Records To Be Transferred to WNRC

Assume the following: (1) An office has checked the Schedule and it has on-hand one or more collections of inactive records for which the Schedule retention periods propose transfer to the WNRC; (2) that a definite date can be given to the Center, in accordance with the Schedule, as to when the records can be destroyed there; and (3) that the required number of boxes to house the inactive stored records have been received from the Bureau Records Management Office.

To properly describe the contents of boxes to be packed, the office will prepare the following listing:

1. **Format.** Use blank paper for the listing describing the records. At least one copy should be kept in the office files and one copy should be sent along with the boxed records to the Bureau Records Management Office.

2. **How to Prepare the Descriptive Box-by-Box Content Listing. See Exhibit 3).** As an example, assume that in the Office of Associate Commissioner of the Office of Publications there are on hand some ten boxes of inactive Program Management Subject Files, Item 264 of the Schedule. These have already been screened from the intermixed administrative subject files and cover the period 1973 to 1983.
 - a. **Enter the date of transfer, Office Identification and Contact Person, on the blank page to start the Box-by-Box Listing.**
For example:
"October 30, 1987
Office of Associate Commissioner,
Office of Publications
Contact: John Doe, Room 2800 GAO Bldg, 523-2000."

 - b. **Enter on listing the item number, file heading, and inclusive dates of the file.**

Look on the Schedule to determine the appropriate item(s) that provides disposal authority for the records collection, and check the records to determine the inclusive dates covered by the materials to be transferred to the WNRC. Enter on the listing the Schedule item number, the file title, and the inclusive dates of the file. Under this heading will be listed the serially numbered boxes comprising the collection.

For example:
"Item No. 263. Associate Commissioner's Program - Administrative Management Subject File, (Program Subject Segment), 1973-1982".

- c. Enter on listing under one or more file headings the serially numbered box content descriptions.

As a minimum, to describe the contents of each serially numbered box fitting under the heading, list the box number, the total number of boxes, and a description of the beginning and ending folder captions or records in the box, if the file is in a usable arrangement. If the file is not well arranged, it may be necessary to list each folder caption or each record to describe the box contents. Also, for clarity, it may be necessary to show the inclusive dates of the records in each box. If the records are confidential, indicate that fact on the listing.

For example, in the case of this particular program subject file, it would be advisable to indicate the inclusive dates of the records in each box after the heading and to list each of the folder captions within each box.

Example:

"Box 1 of 10, Associate Commissioner's Program-Administrative Management Subject File, (Program Subject Segment); 1973-1977.

Articles
Averaging
BRAC
Committees-General
Committee A
Committee B
Committee C
Committee F
Committee S
Conferences-General
Conference A
Conference D
Conference F

Box 2 of 10, Associate Commissioner's Program- Administrative Management Subject File, (Program Subject Segment), 1973-1977.

Conference L
Conference S
Consumer Price Indexes
Consumer Price Research
Employment - General
Employment - Private
Employment - Public
Federal Departments - General
Department A
Department C

Department E
 Department L"
 (and continue through Box 10).

F. Marking Boxes Prior to Pick-up By the Bureau Records Management Office.

Offices requesting storage of records at WNRC do not have available certain of the information required as box labels by the National Archives and Records Administration. Such information on Center accession numbers is centrally maintained at the Bureau Records Management Office, and only that office can apply final box label markings.

Therefore, only temporary box markings can be applied to filled boxes at the requesting office prior to pick-up. Using a pencil, a requesting office should mark on the 12-inch side of each box of a proposed Center transfer the following information:

1. The name of the office requesting the storage.
2. The item number of the Schedule covering the records.
3. The box number of the shipment.

For example: for the 10 boxes of the Associate Commissioner's Program Subject File, each box should be marked with pencil as follows:

1. "Office of the Associate Commissioner, Office of Publications.
2. Item No. 264
3. Box 1 of 10 (Box 2 of 10), etc."

G. Sending Packed WNRC Boxes to the Bureau Records Management Office.

After completing the packing and temporary labeling of boxes to be stored at WNRC and preparing at least two copies of the office box-by-box descriptive content listing, telephone the Bureau Records Management Office, (523-1468), to arrange for them to pick up the boxes, along with one copy of the box content listing.

When the Bureau Records Management Office prepares the required SF 135, "Records Transmittal and Receipt Form," to arrange for the sending of the boxes to the Center, it will send a copy of the form to the requesting office.

H. Servicing Records Stored in WNRC.

Call the BLS Records Management Officer, on 523-1468 whenever a record stored at WNRC is needed. To ensure prompt delivery of the wanted records, refer to your office copy of the transfer documents,

and indicate, if possible, the date of the transfer, the accession number, the box number, and the caption of the wanted records in a box.

V. REVIEW OF THE SCHEDULE

Any Records Disposition Schedule will lose its usefulness unless professionals, supervisors, recordkeepers, or other users regularly review for currency that portion of the Schedule that pertains to their records. As a minimum, such users should review the Schedule annually in accordance with Federal Property Management Regulations (36 CFR 1228.20).

If any changes appear to be needed as a result of the review, please contact the BLS Records Management Officer (523-1468).

If changes are needed, the Records Management Officer will take the necessary steps to prepare and obtain the required approvals for them. After approvals are received, the Records Manager will reproduce and distribute the pages of the Schedule containing revisions. All Schedule holders should interfile the revised pages into the Schedule, and destroy the obsoleted pages.

VI. COORDINATION OF CURRENT FILING PRACTICES

Unless an office installs approved current filing practices that supplement and facilitate eventual disposition of records, it can be difficult and time consuming to apply the retention periods of this Record Schedule. For instance, if proper filing practices are adopted for records at the time they are filed, it can be possible at disposition time to take all eligible records out of a file drawer in toto as a block, and pack the entire file in Federal Records Center boxes, if a Center transfer is indicated.

A. Separating Active Records from Inactive Records. One way to make it easy to dispose of records as a block is to install filing procedures that will physically separate active from inactive records. If these file cut-off procedures are not installed, it is necessary to go through individual folders to pick out the older records, or to select the individual folders ready for disposal within a file. These are time wasting and unsatisfactory procedures.

1. Subject Files. For subject files arranged alphabetically by subject or names or by coded symbols, active records can be separated from inactive records by cutting off the files at the end of a fiscal or calendar year, and setting up a new set of folders. If the file is small enough, it can be broken every 3 years or every 5 years or so. Any materials that are still active in the old file can be brought forward to the new file.
2. Case or Project Files. For case or project files, arranged either alphabetically by names or by assigned numbers or symbols, a separate file for closed cases should be established. Whenever

a case is closed, the date of closing should be marked on the label and the folders should be filed in the separate inactive file.

- B. Intermingling Short-term and Long-term Papers. Avoid intermingling short-term and long-term papers in the same file. When papers that must be kept only two years are filed with others that must be kept five years, practical considerations generally require retention of all of them for the longer period. By reviewing the Schedule, record keepers can acquaint themselves with the short and long-term papers that most commonly occur in their offices. This will enable them to restructure their files to separate papers having different retention values.
- C. Avoid Paper-by-Paper Screening of Files. Screening of files is usually uneconomical and time wasting. If file breaks are adopted, or temporary files are established for papers of marginal value, the need for screening out and separating papers at disposition time can be greatly reduced.
- D. Avoid Interfiling of Restricted and Unrestricted Records. Do not interfile restricted records, the release of which might violate the pledge of confidentiality given to Bureau reporters, with records open to the public. At disposition time, different procedures are required for each type. For example, if restricted records are to be destroyed in the office, they must be shredded to ensure the maintenance of confidentiality. If restricted records are to be transferred to WNRC, they should be stored in a different location than for unrestricted records. Non-restricted records can be disposed of as regular trash or stored without special security arrangements.
- E. Avoid Interfiling Non-Record and Record Materials. Non-record materials, as defined in IA 4 of this Instruction, should not be intermixed with official records. The retention periods of the two types of materials will be different. Non-records also are not acceptable for storage at Federal Records Centers.
- F. Avoid Interfiling Personal Papers and Official Records. Official records are recorded materials made or received either in pursuance of Federal law or in the transaction of public business. Personal papers are recorded materials of a personal or nonofficial character pertaining only to employees' personal affairs that are kept in an official's office.

To avoid interfiling these two types of materials, personnel should identify and clearly label their personal papers, and keep them in separate containers from official files.

Personal papers may be disposed at the option of the official concerned. In no case should so many personal papers be maintained as to cause excessive storage costs.

VII. ASSISTANCE AVAILABLE

If additional advice or assistance is needed on any matters involving records management or applying this Schedule, contact your BLS Records Management Officer - Room 2051 GAO Building, Washington, DC, 523-1468.

Records Storage Box

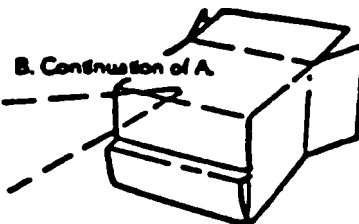
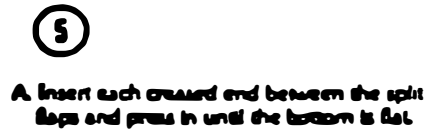
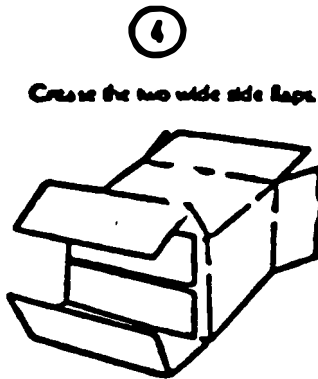
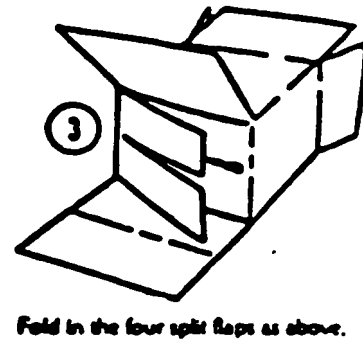
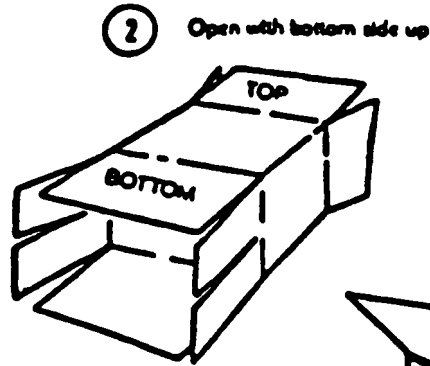
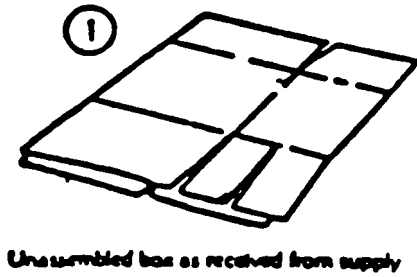

C. Construction of B.

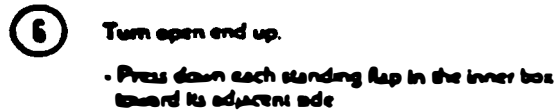
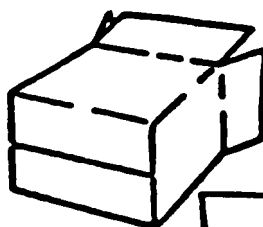

- Do not seal the bottom with tape as it is self sealed when records are inserted

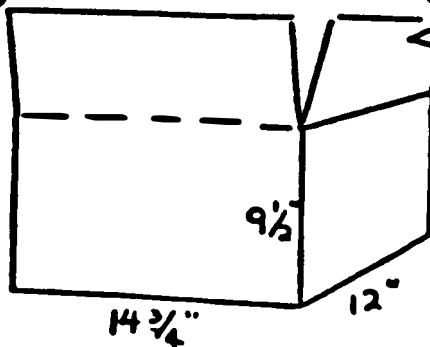

RECORDS TRANSMITTAL AND RECEIPT

Complete and send original and two copies of this form to the appropriate Federal Records Center for approval prior to shipment of records. See specific instructions on reverse.

PAGE
1

OF
PAGES

1. TO (Complete the address for the appropriate records center serving your area)

**Federal Archives and Records Center
General Services Administration**

*As shown in
FPMR 101-11.410-1*

2. AGENCY TRANSFER AUTHORIZATION	TRANSFERRING AGENCY OFFICIAL (Signature and title)	DATE
3. AGENCY CONTACT	TRANSFERRING AGENCY LIAISON OFFICIAL (Name, office and telephone No.)	
4. RECORDS CENTER RECEIPT	RECORDS RECEIVED BY (Signature and title)	DATE

5. FROM (Enter the name and complete mailing address of the office retaining the records. The signed receipt of this form will be sent to this address)

Fold line

6. RECORDS DATA

ACCESSION NUMBER			VOLUME (cu. ft.)	AGENCY BOX NUMBERS	SERIES DESCRIPTION (With inclusive dates of records)	RESTRICTION	DISPOSAL AUTHORITY (Schedule and item number)	DISPOSAL DATE	COMPLETED BY RECORDS CENTER			
RG	FY	NUMBER							LOCATION	SHELF PLAN	CONT. TYPE	AUTO. DISP.
(a)	(b)	(c)	(d)	(e)	(f)	(g)	(h)	(i)	(j)	(k)	(l)	(m)

-XIV-

EXHIBIT 2

SAMPLE OF OFFICE BOX-BY-BOX DESCRIPTIVE
CONTENT LISTING

1. Date of Transfer, Office Identification, Contact Person.

"October 30, 1987
Office of Associate Commissioner,
Office of Publications
Contact: John Doe, Room 2800 GAO Bldg, 523-2000."

2. Filing Heading and Inclusive Dates.

"Item No. 264.

Associate Commissioner's Program - Administrative Management Subject File, (Program Subject Segment), 1973-1982."

3. Box Number, Total Boxes and Content Description of Each File.

"Box 1 of 10, Associate Commissioner's Program Administrative Management Subject File, (Program Subject Segment), 1973-1977.

Articles
Averaging
BRAC
Committees-General
Committee A
Committee B
Committee C
Committee F
Committee S
Conferences - General
Conference A
Conference D
Conference F

Box 2 of 10, Associate Commissioner's Program - Administrative Management Subject File, (Program Subject Segment), 1973-1977.

Conference L
Conference S
Consumer Price Indexes
Consumer Price Research
Employment - General
Employment - Private
Employment - Public
Federal Departments General
Department A
Department C
Department E
Department L"
(and continue through Box 10)

Keep at least one copy in office files. Send one copy along with boxes to Bureau Records Management Office. Attach office copy to SF 135 when it is received from the Bureau Records Management Office.

OVERALL ADMINISTRATIVE HISTORY OF
THE BUREAU OF LABOR STATISTICS

A Bureau of Labor was established in the Department of the Interior by 23 Stat. 60 of June 27, 1884, headed by a Commissioner of Labor. It was the first formal Federal organization unit established for the specific purpose of collecting and compiling information relating to labor conditions in the United States. The language of the Act establishing this Federal Bureau was based on an Act of June 23, 1869, of the State of Massachusetts which created the Massachusetts Bureau of Statistics of Labor.

As a result of a request made by the Knights of Labor that a Department of Labor be created independent of any of the federal departments, Congress passed the Act of June 13, 1888 (25 Stat. 182) establishing a Department of Labor without rank. The head of the Department retained the title of Commissioner and continued the same responsibilities provided by the Act of June 27, 1884. These assignments were continued when the Department of Labor was incorporated as a bureau into the Department of Commerce and Labor, newly created by the Act of February 4, 1903 (32 Stat. 825). About a year later, by the Act of March 18, 1904, the title of the Department of Labor was formally changed to the Bureau of Labor in this newly established Department.

The first Commissioner of Labor, named by President Chester Arthur in January 1885, was Carroll D. Wright, formerly Chief of the Massachusetts Bureau of Statistics of Labor, which had served as a model in the establishment of the Federal Bureau of Labor. Mr. Wright served as Commissioner until January 1905. He quickly moved to establish professionalism and impartiality in the National Bureau. He stressed the impartial gathering of facts on the various matters affecting labor. The facts were to be gathered in accordance with statistical methodology and were to be published to be available for all to assess and act upon.

Under Mr. Wright, during his twenty year stewardship of the Bureau, various Bulletins and Annual and Special Reports were issued covering such subjects as: industrial depressions, strike investigations and industrial relations, working women and children, urban and ethnic matters, tariffs, wages and prices, and international labor matters. Mr. Wright also participated in the settlement of various labor disputes.

As of 1905, Dr. Charles P. Neill was appointed as the second commissioner of the Bureau of Labor, which after 1903 had become a Bureau in the Department of Commerce and Labor. He had been a Professor of Political Economy at the Washington, D.C. Catholic University. He served as Commissioner until 1913, resigning shortly after the establishment of a separate Department of Labor in 1913, and the change of the name of the Bureau from Bureau of Labor to Bureau of Labor Statistics.

Dr. Neill continued the work begun by Mr. Wright during these formative years, and strengthened the headquarters-field fact gathering and statistical analysis work. Collection of data on wholesale and retail prices and employee wages were the principal concerns of the network of Bureau field agents. In keeping with the policies of President Theodore Roosevelt and the progressive movement, Dr. Neill placed emphasis on studies for economic and social reform,

such as studies of working conditions of women and children and of industrial safety and health.

As of August 1913, Dr. Royal Meeker, formerly a professor at Princeton University under Woodrow Wilson, became the third Commissioner of Labor Statistics. The Act of March 4, 1913, placing the Bureau of Labor Statistics in the Department of Labor provided that the Bureau, under the direction of the Secretary, should collect, collate, and report at least once each year, or oftener if necessary, full and complete statistics on the conditions of labor and the products or distribution of the products created.

Under Dr. Meeker the Bureau faced a prewar recession and a wartime economy. To meet these conditions, reports on unemployment and employment were begun as well as studies of cost of living under the wartime induced inflationary pressures. Also family budget studies were undertaken. As of 1915, the periodical, Monthly Labor Review was established as a vehicle for disseminating Bureau study results. Dr. Meeker resigned in 1920 to work for the International Labor Office of the newly established League of Nations in Geneva.

The next Commissioner, Ethelbert Stewart, served in the post-war period from 1920 to 1932. He had served in the BLS and its predecessor agencies for some 33 years prior to his appointment. The political climate during this period of relative prosperity and ending with the Great Depression was not a favorable one for the Department of Labor and the BLS. Mr. Stewart worked to improve the traditional statistical employment, price, wage, and industrial safety programs of the Bureau, and instituted new programs in the measurement of labor productivity.

In 1921, at the beginning of his term, the Bureau was organized as follows: the Office of the Commissioner; the Office of the Chief Statistician, including Divisions of Correspondence and Files, Accounts and Supplies, and Special Field Investigations; the Statistical Division including Sections for Wages and Labor Conditions, Wholesale Prices, Retail Prices, Cost of Living, Industrial Accidents, Strikes and Lockouts, and Volume of Employment; an Editorial and Research Division; and a Law Division. Much of the time Commissioner Stewart was concerned with budgetary cuts and attempts to maintain the various statistical outputs and studies of the Bureau. While his 4 year term as Commissioner ran until December 1933, Stewart, then 74 years old, was retired involuntarily as of July 1932. Charles E. Baldwin, Assistant Commissioner under Stewart, served as Acting Commissioner until the appointment of Isador Lubin in July 1933 as Commissioner of Labor Statistics.

Since 1922, Isador Lubin had taught and led economic studies at the Brookings Institution in Washington, D.C. Dr. Lubin was prominent among the economists who saw the need for an increased role for the Federal Government in economic affairs, especially after the onset of the Depression. Dr. Lubin was closely associated with Secretary of Labor Frances Perkins, and together they attempted to improve the Bureau's staff and programs so as to provide reliable, economic statistical data for the various Federal agencies established under President Roosevelt to foster economic recovery from the Depression. Outside consultants were brought in to provide advice concerning the methods, adequacy, usefulness, and general program of the BLS. Dr. Lubin and Mrs. Perkins were also active in promoting the coordination of Federal

Statistical agencies. He handled various special assignments for the Secretary, and through her was given various White House assignments.

As of June 1940, he was designated as Economic Advisor to the head of the Labor Division of the National Defense Advisory Commission, and by May 1941 was appointed special statistical assistant to the President. He retained the title of Commissioner of Labor statistics until 1946, but as of June 1940 he designated A. Ford Hinrichs, the Bureau's Chief Economist, as Acting Commissioner to carry out the work of the Bureau to provide needed wartime statistics.

From 1933-1946 under the Lubin-Hinrichs Commissionerships, many of the programs of the present BLS were enhanced or begun. Emphasis was placed on cost-of-living indexes, standard family budgets, wages and hourly earnings, wholesale prices, industrial relations, labor productivity and technology, and industrial safety and health. Further enhancement was made also in the establishment of regional offices for collecting wage, price, and employment data. As of July 1946, when Mr. Hinrichs resigned as Acting Commissioner, the Bureau had some 1,700 employees to carry out its programs.

As of August 1946 Ewan Clague became Commissioner, a post he held until 1965, except for a short interruption during 1954-55 when his renomination to another four year term was held up. During this period, his Deputy Arynness Joy Wickens, served as Acting Commissioner.

Mr. Clague, a distinguished economist had served since 1940 as Director of the Bureau of Employment Security and had numerous previous contacts with the BLS, going back as far as 1926 when he had worked for the Bureau in developing labor productivity indexes.

He faced immediate budget problems during the 1946 post-war budget reduction period, having to let go some 700 of the Bureau's 1,700 employees. During his Commissionership, the Bureau faced many proposals, both inside and outside the Department of Labor, for reorganizations and adding or losing various statistical functions, and various outside Commissions studied the work of the Bureau. Much reimbursable work was undertaken for other Bureaus of the Department of Labor, such as the Manpower Administration and others.

Emphasis on the use of Bureau statistics as economic indicators for setting national economic policy developed during his terms of office. Such agencies as the newly created Council of Economic Advisors and the Congressional Joint Economic Committee were among the users. Also in 1948 an agreement between General Motors Co. and the United Auto Workers Union calling for use of the Consumer Price Index and productivity measures for adjusting wages increased public awareness of the Bureau's statistical programs. Following this agreement, many other private and governmental organizations began using BLS price indexes in wage adjustments, such as in union contracts arrived at through collective bargaining.

Mr. Clague, therefore, placed great emphasis on improving the statistical reliability of the Bureau's various indexes, despite budgetary problems. During this period, cooperative agreements with states were put in place involving the collection of employment data by state agencies and the analysis and publication of such data by the Bureau. Several major revisions of the

Consumer Price Indexes were undertaken, including a major revision of its Market basket data in the 1961-2 period. Also in the early 1960's, the Bureau undertook economic growth studies for the analysis and projection of economic growth trends. Others of the Bureau's statistical programs were enhanced during this period such as statistics covering wages and industrial relations, industrial safety and health, wholesale prices, labor force, standard family budgets, productivity and technology, and international labor conditions.

Mr. Clague's work did much to provide the Bureau with an accepted public image as a non partisan professional organization issuing reliable statistics and included the beginnings of the computerization of the various statistical programs of the Bureau.

Under the next Commissioner, Arthur M. Ross, who served as Commissioner from October 1965 to July 1968, work began to modernize the Bureau and to further the use of automatic data processing operations as applied to its major statistical systems. Dr. Ross had been a Professor of Labor Management Relations at the University of California. Dr. Ross employed the management consulting firm of Booz-Allen and Hamilton to propose a major reorganization of the Bureau and its operations. However, he resigned as of July 1968, and Ben Burdetsky, his Deputy Commissioner, who had been assigned the task of managing the reorganization, was named Acting Commissioner.

Mr. Burdetsky served until March 1969, when Geoffrey H. Moore, of the National Bureau of Economic Research and past president of the American Statistical Association was named as Commissioner. Under the reorganization of the Bureau by January 1966 the positions of Chief Statistician and Chief Economist were established. By 1970, the management of the computer operations within the Bureau had been centralized under an Office of Data Collection and Survey Operations, and the systems development work had been placed under the Chief Statistician.

This centralization of functions foreshadowed the present day organization of the Office of Survey Processing and the Office of Technology and Operations Review. By 1972, however, the positions of Chief Economist and Chief Statistician had been abolished, and a Special Assistant for Field Operations had been established under the Deputy Commissioner, Mr. Burdetsky. This position was a forerunner to today's centralized management of Regional Operations under the present Office of Field Operations.

Commissioner Moore resigned as of January 1973, when he turned in his pro-forma resignation as a political employee and it was accepted. In July 1973, Julius Shiskin, an economist and statistician who was formerly head of the Office of Statistical Policy of the Office of Management and Budget, became the next Commissioner.

Commissioner Shiskin emphasized the non political nature of the work of the Bureau and the importance of maintaining its professional image with the ever-growing use of its indexes as national economic indicators. By then, most Federal wages, retirement, and entitlement programs as well as most union collective bargaining contracts had been linked with the Bureau's price indexes for adjustments needed to compensate for inflation. Such indexation required complete confidence of all in the nonpolitical nature of the Bureau's operations.

Commissioner Shiskin stated that he expected to complete his four year term and would not submit a pro-forma political resignation. He also had insisted on a regular schedule of release of data with written press releases that had been issued at least one hour before any policy or political commentary was to be made.

Under Commissioner Shiskin, major improvements were made in the CPI, with development as of 1978 of the CPI-U (Urban) representing a much broader coverage than the traditional CPI-W, which was also continued. By 1976, the first comprehensive revision of the old Wholesale Price Indexes was begun, which resulted by 1983 in the issuance of the present Producer Price Indexes. Most of the traditional statistical programs were also enhanced. In the wage area, for example, to meet the demand for a broad general wage measure to serve as an economic indicator, in 1976, the Bureau began quarterly publication of its Employment Cost Index, measuring quarterly changes in wages and salaries. The ECI has since been expanded in coverage over the years.

By 1978, Commissioner Shiskin had become seriously ill, and he died in office as of October 1978. The present Commissioner, Janet L. Norwood, was named acting Commissioner during 1978. She had been Deputy Commissioner, and had been associated with the Bureau since 1963 in ever-increasing positions of responsibility primarily in the price office.

As of March 1979, President Carter nominated her as the first woman to serve as Commissioner. She has stressed the need for reliable and accurate statistics to be generated by the Bureau relevant to the country's economic and social needs.

Although in Fiscal Year 1982, the Bureau faced a 12 percent budget cut, Commissioner Norwood was able to protect the Bureau's core programs, and winnowed out certain other programs of limited application. Up to the time of this writing, in 1987, she has been able to improve the scope and quality of data on consumer prices, producer prices, employment and unemployment, and wage and benefit costs. A comprehensive revision of the CPI was put in place in 1987, and multifactor productivity statistics had been begun under her leadership. The bureau also had assumed responsibility for administering the Federal/State Cooperative national labor information programs.

As of 1987, Mrs. Norwood was reappointed to her third four-year term as Commissioner, capping her efforts to assure that the work of the Bureau will continue under the highest possible standards of professionalism and integrity.

Binder of Schedule

This Schedule is presented in a format reflecting the organization of the Bureau of Labor Statistics Offices covered as of the time of this writing in 1987. Its disposition authorizations will remain in effect regardless of any future organizational changes in the BLS Offices covered as long as the files described in its contents to accumulate and serve the same purpose.

EXPLANATORY STATEMENTS

A. Documentation of Survey Methodology.

BLS systemically documents the methodological approaches adopted in developing and issuing its survey data in the following manner:

1. Publishing Explanatory Methodological Statements. A BLS Handbook of Methods is published and updated periodically to explain the statistical methodology used in the various statistical programs of the Bureau.

In addition, Technical Notes are included in the monthly Bulletins providing methodological explanations of the statistical methodology. The record copies of such publications are listed as permanent on the Schedule to ensure their appropriate preservation.

2. Maintenance of Internal Statistical and Procedural Manuals and Technical Memoranda. The Office of Field Operations, in collaboration with the particular program offices involved, is responsible for the printing and distribution to Regional Offices of such explanatory materials as internal statistical and procedural manuals covering the detailed operations involved in sampling, collecting, and analyzing the data required to issue the various statistical reports and bulletins of the bureau. The Office of Field Operations also provides such distribution services for the Technical Memoranda issued documenting the detailed procedures involved in carrying out specific surveys involving Regional Offices. The record copies of such manuals and Technical Memoranda are listed as permanent records in the BLS Disposition Schedules for the Program Offices concerned rather than for this schedule covering certain functions of the Office of Field Operations.

In addition, the Office of Technology and Operations Review (OTOR) covered by this schedule is responsible for the operations of the LABSTAT system containing many of the permanent machine readable time series results of BLS surveys. This Office issues such manuals as a user guide and a series directory to assist users of machine-readable records. In addition, OTOR serving as a computer support office for the Management Information System and other systems, provides detailed descriptive documentation for the computerized operations involved. Such documentation is listed as permanent on this schedule.

B. Long Term Tape Maintenance.

BLS will provide required maintenance procedures to machine-readable records transferred to WNRC for a period of more than five years storage. A notification system will be established to identify those stored BLS tapes needing maintenance procedures in order to comply with the requirements of 41 CFR 36-1207 covering maintenance of machine-readable records.

C. Record Copy of BLS Publications.

The term "record copy" for publications is used in this Schedule to designate the most complete set of a BLS publication in the best physical

condition which will be a permanent record for eventual transfer to the Archives of the United States.

D. Micrographic Publication Standards.

When micrographic publications are to be accessioned to the Archives of the United States in lieu of printed copies, the microfiche are to be prepared in accordance with 36 CFR 1230.14.

IMMEDIATE OFFICE OF THE COMMISSIONER FOR THE
BUREAU OF LABOR STATISTICS

The immediate Office of the Commissioner for the Bureau of Labor Statistics presently consists of the Commissioner, the Deputy Commissioner for Administration and Internal Operations, two Special Assistants to the Commissioner, and the secretarial staff.

Three major categories of records covering the activities of the present Commissioner exist in the immediate Office of the Commissioner. These are:

1. Files, both current and noncurrent, directly attributable to the present Commissioner.
2. Current files attributable to the present Deputy Commissioner for Administration and Internal Operations.
3. Current and inactive files attributable to the overall Office of the Commissioner, including those of the present Special Assistants and previous Special Assistants.

Records of previous Commissioners prior to 1978 have already been accessioned to the National Archives of the United States.

A. Files Attributable to the Present Commissioner

1. Commissioner's General Office Files. The primary collection of records maintained by Mrs. Janet L. Norwood, Commissioner for BLS at the time of this writing, is known as the Commissioner's General Office file. On hand in the Commissioner's outside Office at the time of this writing are the Current files representing the current three years of these files (1985-1987), which are broken annually. In cabinets in the Commissioner's study and in the back room storage area are the inactive general office files, reflecting Mrs. Norwood's tenure prior to 1985.

The files consist of incoming and outgoing correspondence, reports, copies of proposed legislation, committee records, and other related general correspondence-types of documents. The General Office file reflects the major official activities involving the present Commissioner.

The General Office file consists of three major segments -- the Outside Department of Labor A-Z segment, the Department of Labor segment, and the BLS file segment. While each segment is primarily organized on the basis of the organizations or persons involved with the Commissioner, subject matter or issue-oriented folders are maintained as subarrangements within the organizational or alphabetic primary file arrangements.

The Outside Department file segment consists of materials originating from or sent to persons or organizations outside the Department of Labor. It is the only alphabetically arranged file segment. It contains general A to Z folders for correspondence not involving various subjects or organizations for

which separate folders are maintained, as well as special subject or name folders for issues (subjects) or organizations for which enough records are generated to warrant special folders.

Both the Department of Labor and the BLS file segments are arranged on the basis of the organizational units concerned, starting with the Office of the Secretary and the Office of the Commissioner respectively, and then arranged by their position in the organizational hierarchy. As required, within the files established for various organizational Bureaus or Offices, separate issue or subject file folders may be set up when the volume of documents warrants such special folders.

As required continuing types of records, such as those involving committees or important policies may be brought forward from a closed year's files to the current year's files.

Retention Period. Permanent. Rearrange older files as required to ensure appropriate file arrangement. During annual file break bring forward to current year's files appropriate precedent and important policy materials such as agreements, freedom of information precedent cases, etc., and other active materials as required. Offer for transfer to the National Archives of the United States within two years of termination of the Commissioner's appointment. .

2. Commissioner's Personal Files. The Commissioner's personal file reflects primarily activities in which the Commissioner has personally participated. The file is not broken yearly as a whole, as in the case of the General Office File, but there are some chronologically arranged segments of the file which have been cut-off and stored in the back room storage area.

The following describes the contents of the several major segments comprising the Commissioner's Personal file:

- a. The Non-Governmental Organization-Committee segment of the Personal File contains documentation reflecting mainly the Commissioner's personal participation as an officer, committee or working group chairperson, or member of various non-governmental national or international economic, statistical, or academic organizations. The records consist of materials on various meetings, agendas, drafts, comments, reports of organizations, background materials on the organizations, membership records, and the like.
- b. The Governmental Organization-Committee segment of the Personal File contains documentation reflecting the Commissioner's participation in various international or other governmental organizations, such as the Organization for Economic Cooperation and Development. The records consist of materials of a similar nature as those for non-government organizations.
- c. The Speech-Meeting-Travel chronologically arranged segment of the Personal File contains documentation reflecting the preparation and presentation of unpublished speeches by the Commissioner and attendance at meetings or conferences, of various organizations,

for many of which the Commissioner may not have had a personal affiliation. The records consist of such materials as full texts of speeches, outlines only of speeches, background materials, and materials reflecting travel to and attendance at the meetings or conferences involved.

- d. The published Article-Publication-Speech chronologically arranged segment of the Personal File contains documentation reflecting the preparation by the Commissioner of these types of published materials as an official representative of the BLS. Records of the file consist of an intermixture of both record and distribution copies of the publications.
- e. The Commissioner's personal correspondence, employment history, and miscellaneous personal matters segment of the Personal File contains documentation reflecting personal correspondence prepared by the Commissioner, the employment history of the Commissioner, and various other personal activities of the Commissioner, such as biographical sketches, photographs, travel vouchers and the like.

Retention Period.

- (1) Copies of speeches, articles, and other publications. ~~_____~~
Retention Period. PERMANENT. Break file annually. Bring forward active material. Retire to the WNRC when 10 years old, or sooner if no longer needed for administrative use. Transfer to the National Archives when 20 years old.
- (2) All other records reflecting the Commissioner's activities in a capacity as a high level government official. Transfer to the WNRC when 10 years old. Destroy when 20 years old.
- (3) Records reflecting personal non-government activities of the Commissioner are not covered by this schedule.

3. BLS Office and Divisional Monthly Progress Reports and Occasional Overviews. Consists of the monthly progress reports and occasional overviews from Associate Commissioners of the Bureau's Offices and from the Division Chiefs within the Offices comprising the BLS. The reports are addressed to the Commissioner, and are arranged chronologically (1978 - date).

Retention Period. Permanent. Transfer to the WNRC when 10 years old. Establish a new file upon appointment of a new Commissioner. Offer for transfer to the Archives of the United States ~~_____~~ when

20 YEARS OLD.

*4. SES Employees Standards and Appraisal Files. The Commissioner maintains special personnel history files on the Bureau's SES employees. The files are arranged by year and by name of SES employee thereunder. Folders contain copies of the employee's performance standards and the evaluations of the employees.

This file is covered by the Privacy Act.

Retention Period. Destroy 5 years after date of appraisal. (GRS 1 - Item 23b)

5. Special File on Commissioner's Congressional Testimony Including Joint Economic Committee Testimony. Consists of a separate file maintained covering statements and testimony of the Commissioner before congressional committees including mainly statements regularly made to the Joint Economic Committee of the Congress. Certain congressional issuances are also included.

Arranged primarily by date.

Retention Period. Transfer to the WNRC when 10 years old. Destroy when 20 years old.

6. Commissioner's Special File on Improvement Efforts Involving Local Area Unemployment Statistics. This is an inactive file covering the period 1976-1978 maintained by the Commissioner concerning the Bureau's improvement effort made during that period pertaining to the Local Area Unemployment and Labor Force Statistics program. The file includes monthly folders covering the period January to June 1978, and covers various statistical approaches considered to improve the "Handbook" method for developing these statistics.

No overall apparent arrangement.

Retention Period. Permanent. Transfer to the WNRC when 15 years old. Offer for transfer to the Archives of the United States [redacted] when 20 years old.

7. Selected Inactive Commissioner's Documents Reflecting on Bureau History, Functions, Organization, and Policy Matters. The file consists of selected documents maintained separately in boxes reflecting on the history, functions, organization and policy matters of the Bureau. These documents appear to have been selected to provide Commissioners with continuity and needed background information on the Bureau. The files consist of such materials as early published histories of the Bureau, Statements of the Secretary of Labor on the responsibilities of the BLS Commissioner, functional statements and organizational charts, special briefing books assembled on the activities and programs of the Bureau for presentations by the Commissioner to various Secretaries of Labor, officials of OMB, and the like.

No apparent arrangement.

Retention Period. Permanent. Break file at end of a Commissioner's term and start new file. Bring forward active material. Retire inactive material to the WNRC. Transfer to the National Archives [redacted] when 20 years old.

8. Speech and Article File of Former Commissioners Geoffrey Moore and Arthur Ross. This small file consists of three binders which contain in numerical order copies of newspaper articles attributed to these Commissioners, articles in periodicals prepared by these Commissioners, and copies of speeches made by these Commissioners. The file appears to have been

pecially assembled and organized, and covers the period 1966-1972.

Arranged numerically.

Retention Period. Permanent. Transfer to the WNRC when 15 years old. Offer for transfer to the Archives of the United States ~~when 20 years old.~~
~~when 20 years old.~~ when 20 years old.

9. Special Continuing Federal Committee Files of the Commissioner. A small separate file has been maintained for certain Federal Committees in which the Commissioner has had an interest. Some of the files date previously to her appointment as Commissioner. The Committee folders can contain such records as correspondence, reports, membership determinations, minutes and agendas of meetings, comments on actions taken and the like.

The small file is in no apparent order and dates from 1969 to 1985.

Retention Period. PERMANENT. Break file annually. Bring forward active material. Retire to the WNRC when 15 years old, or sooner if no longer needed for administrative use. Transfer to the National Archives when 20 years old.

B. Files Attributable to the Present Deputy
Commissioner for Administration and
Internal Operations

10. Deputy Commissioner's General Office Files. The Deputy Commissioner for Administration and Internal Operations maintains a general office file arranged in a similar manner as the General Office file of the Commissioner. There is an Outside Department A-Z file segment, a Department of Labor file segment arranged organizationally, and a large segment for the BLS arranged organizationally with subject matter folders thereunder. The file is not broken yearly, as is the case of the Commissioner's General Office correspondence file, but covers the period 1982 to date.

The Deputy Commissioner is primarily concerned with BLS Administrative Management and Internal Operations activities. Such topics as the following are covered in the file: ADP Procurement, Laser Print Proposal, Purchase of Microcomputers, Software Maintenance, Computer Costs, EDS Contract, Regional Terminal Network, Computer Assisted Telephone Interviews, Building Security, Space, Budgets, Foreign Training, Local Area Network, Collective Bargaining Agreement, Department Awards Ceremony, Merit Pay, Grievances, Advance Procurement Plan, and the like.

Basically, this is a General correspondence file reflecting an overall, high-level interest in and direction of the administration and internal operations of the BLS, including oversight as to the development and installation of automated systems for information handling and the generation of statistical data.

Retention Period. Permanent. Break file at least every five years. Bring forward precedent materials and active and continuing materials to the new file as appropriate. ~~Offer for~~ Transfer to the National Archives of the United States in 5 year blocks when the most recent record is 20 years old.

→ Retire to the WNRC when 10 years old.

C. Files Attributable to the Overall Office
of the Commissioner

11. Office of Commissioner Chronological File. An Office chronological file is maintained which contains copies (typically green) of all materials prepared by the Commissioner, the Deputy Commissioner, or the Special Assistants to the Commissioner. These copies, arranged by date, can include copies of personal correspondence of the Commissioner.

Retention Period. PERMANENT. Break file annually. Bring forward active material. Retire to the WNRC when 10 years old, or sooner if no longer needed for administrative use. Transfer to the National Archives when 20 years old.

12. Commissioner's Office Correspondence Control Hard Copy File. The File consists of binders and other records containing form records relating to control over the receipt, referral and answering of incoming correspondence within the Office of the Commissioner. Much of the correspondence is routed throughout the Bureau for preparation of replies for the signature of the Commissioner.

Machine readable data files are also maintained as part of the correspondence control system.

Retention Period. Destroy when 3 years old.

13. Commissioner's Office Machine Readable Correspondence Control System File. As part of the overall Commissioner's Correspondence Control system, identifying information on each document being controlled is entered into a data file presently being maintained under the Wang system, but in the near future to be maintained as a data file on the disk of the file server for the central Bureau LAN system. Such machine readable data files are useful in analyzing over a time period the Bureau's performance in promptly replying to incoming correspondence received at the Office of the Commissioner.

Retention Period. Scratch when 5 years old.

14. Office of the Commissioner Time and Attendance and Time Distribution File. Consists of various form records involving the maintenance of time and attendance and time distribution files for the office of the Commissioner. These files include biweekly time and attendance forms and time distribution sheets, flexitime log records, and earning and leave statements.

The record copy of these files are maintained in the central Office of Administration of the Bureau.

Retention Period. Destroy after GAO audit or when 3 years old, whichever is sooner, as per GRS 2, Item 3.

15. Work Files of Special Assistants to the Commissioner. The files consist primarily of such materials as working papers, extra copies, background materials, records reflecting work on assigned issues, copies of speeches or testimony in which input has been made, budgetary materials, clearance records, machine printouts, and the like maintained by present and past Special Assistants to the Commissioner.

No record copies of final products produced by special assistants are maintained in these files. The record copy of any of such materials would be in the files maintained by the Commissioner or possibly the Deputy Commissioner.

Any documents which a special assistant might sign would be included in the office chronological file.

Retention Period. Destroy when no longer needed for current business.

16. Legislation Review and Comment File Previously Maintained by Special Assistant Myrtle Nelson. While reviews and comments on legislation affecting the Bureau are currently maintained in the general office file, files on this activity are on hand that were kept separately by former Special Assistant Myrtle Nelson for the period 1974-1980. The files typically consist of request for comment forms from the Solicitor's Office of the Department of Labor, and comments and statements of the Office of the Commissioner on proposed legislation affecting the Bureau. Arranged primarily by date.

Retention Period. Permanent. Transfer to the WNRC when 10 years old. Offer for transfer to the Archives of the United States ~~when 20 years old.~~ *when 20 years old.*

17. Technical Reference Files, Office of the Commissioner. The Commissioner, Deputy Commissioner, and Special Assistants maintain background technical reference materials files, typically on shelving or in bookcases. These files consist of extra copies, various periodicals or single publications and printed materials, copies of instructional manuals covering various BLS programs of interest to these officials, machine listings, and copies of various instructional manuals covering computerized operations, statistical procedures, and statistical methodology.

Retention Period. Screen files once a year. Destroy superceded, obsoleted and materials no longer needed for current business.

18. Machine Readable Word Processing Disk Files, Office of the Commissioner. A stand-alone Word Processing System is maintained in the Office of the Commissioner for the preparation of both individual correspondence, or as required, for the preparation of periodic types of lengthy documents requiring updating, such as budgetary materials, materials on the BLS Centennial, and the like. Disks are used as the recording media for the system.

Retention Period. Scratch when no longer needed for current business.

OFFICE OF THE COMMISSIONER
MANAGEMENT INFORMATION SYSTEMS STAFF

The Management Information Systems Staff of the Office of the Commissioner, BLS, at the time of this writing, consists of a Program Director, two Program Analysts and an office secretary. The staff is responsible for such matters as the overall management, development, enhancement, and utilization of the various automated management, financial management, and personnel utilization Management Information Systems required for effective operations within the BLS.

Much of the work of the MIS Staff is undertaken cooperatively with teams of personnel consisting of representatives of other BLS staff, program, and support offices. In order to control the many projects carried out by the MIS Staff, a Project Planning and Management Control System has been installed. This system provides for planning, scheduling, managing, monitoring, and documenting of the various formal projects that have been established to reflect the assigned tasks of the MIS Staff.

19. MIS, Program Director Program Subject File. The Director of the Management Information Systems Program maintains a program subject file reflecting his program responsibilities for managing the Management Information Systems for the BLS. The file consists of various printouts, drafts, correspondence, committee records, task force reports, copies of reports from MIS Systems and the like. Both active and inactive file segments are included, and the files also reflect some of the Director's activities while serving previously as Executive Assistant to the Commissioner of BLS.

Included in these files are documents pertaining to such matters as contractor's reports involving certain of the systems, printouts of reports generated by systems, training personnel in use of the systems, progress reports made to the Commissioner, budget formulation and execution, LABSTAT-NTIS activities, Bureau financial management systems, equipment inventory systems, procurement systems, project planning and control systems, extra copies of system documentation materials, and the like.

Current hard copy program planning files are maintained under a numerical 4-digit coding scheme as machine readable PC Hard Disk files or as floppy diskettes.

Retention Period.

- a. Hard Copy Files. Break file every 5 years *and bring forward active materials.*
Transfer to the WNRC. ~~Destroy when 10 years old, or when no longer needed for current business, whichever is sooner.~~
Destroy when 10 years old, or when no longer needed for current business, whichever is sooner.
- b. Machine Readable Files. Scratch when no longer needed for current business.

20. MIS Staff Office Project Files. The internal workload of the MIS Staff and cooperating Bureau organizations involved with the MIS staff is identified, documented, and controlled under a detailed automated project management system, known as the Project Planning and Management Control System,

which Uses Primavera and RAMIS program packages. Each project is identified by a distinctive project number, and the detailed work in carrying out each project is subdivided into formal activities, with each activity of a project also being assigned an identifying number prior to beginning work on project.

Many of the projects of the MIS Staff involve various Bureau Staff, administrative, program, or support offices, and teams of persons from all offices concerned are assembled to carry them out, if such is the case.

Project records are maintained in both machine readable and hard copy formats. Several types of project machine readable records may be maintained, depending on volume or other factors, such as data maintained on internal hard disks of office P.C.s, data placed on floppy diskettes, or if very voluminous, data maintained at the central Bureau Computer facility.

The hard copy paper records on projects are maintained under the numerical coding system, with separately numerically coded folders established for each activity into which the work of a project has been established.

The Project Planning and Management Control System provides for detailed controls over both the scheduling of the completion of each activity of a project and also the maintenance of the records which are generated by a project. A detailed inventory of all projects under the System is maintained on disk files of the central Bureau Computer facility.

Typically projects can involve the development or enhancement of a particular MIS System, the preparation for a speech or conference, or any other of the internal tasks undertaken by the MIS staff, either on its own, or in conjunction with other organizational units of the BLS.

Retention Period

- a. Hard Copy Records. Set up a separate file for hard copy records involving inactive projects. Destroy when superceded, obsoleted, or when no longer needed for current business.
- b. Machine Readable Files. Scratch when superceded or when no longer needed for current business.

21. MIS Office Administrative Program Subject File. The secretary to the Director of the Management Information System Program maintains an office administrative program subject file reflecting primarily the administrative activities for which she has responsibility.

The general correspondence file and related materials is in two segments. The first segment covering 1984 to date is an alphabetically arranged subject file consisting of correspondence, reports, printouts, task force records, committee records and the like. It covers such subjects as Performance Standards and Appraisals, Procurement Plan, Flexitime and Time and Attendance, Commissioner's Correspondence Control System, GAO Management Review, and the like.

The previous year's files covering the period 1979-1983, reflecting similar type subjects were maintained under a 4-digit numerical coding scheme.

Record copies of administrative records are maintained in the Central Bureau Office of Administration.

Retention Period. Break file every 5 years. Bring forward active materials to new files.

- a. Administrative Records. Destroy when 5 years old.
- b. Program Records. Transfer to the WNRC when 5 years old. Destroy when 10 years old, ~~or when no longer needed for current business, whichever is sooner.~~ *KRW*

22. Office Incoming BLS Internal Memoranda File. The secretary to the Director maintains a small file in binders for incoming internal BLS memoranda received in the office. The file is chronologically arranged.

Retention Period. Destroy when no longer needed for current business.

23. Office Reading File. The Secretary to the Director of the MIS Program maintains in binders an extra copy chronological reading file consisting of copies of documents prepared in the office.

Retention Period. Destroy when 1 years old.

24. Office Word Processing Diskette Files. In connection with the Word Processing of documents for the MIS Staff, machine readable diskettes are generated by the MIS Staff secretary. Such diskettes are working media used to facilitate the production or revision of hard copy documentation of the MIS Staff.

Retention Period. Scratch when no longer needed for current business.

25. Program Analyst Program Subject-Work Files. Particularly the Senior Program Analyst, but also other MIS Staff Program Analysts as required maintain mixed Program Subject - work files reflecting their assigned responsibilities in the management of various MIS Systems. These files can include both hard copy and PC hard disk or floppy diskette machine readable files. The files can include both extra work copies and some record copies of materials.

Included are materials on such matters as the development, maintenance, or operations of the Operating Information System, the Financial Profile System, the Employee Position Information System, and the like, as well as materials on the development of printout instructional statements for users of the various Systems, and the answering of requests for ad-hoc reports to be generated by the various systems, extra copies of System documentation materials, and the like.

Retention Period:

- a. Record copies of documents. Such as instructional statements to users and system development records. Destroy when 10 years old.

- b. Extra copy work files. Destroy when superceded or when no longer needed for current business.
- c. Machine Readable Files. Destroy when superceded or when no longer needed for current business.

26. MIS System Report Printout Copy Files. Program Analysts maintain copies of current biweekly, or monthly, or other periodic or ad-hoc report printouts produced from computer runs of the various MIS Systems. These printouts of System reports are received from the MIS Staff Support Office and the program managers distribute them to the various Officials of the BLS authorized to received them.

Retention Period:

- a. Periodic Report Printouts. Destroy when superceded by more current printouts
- b. Ad-Hoc Run Printouts. Destroy when no longer needed for current business.

27. MIS Computer Run Log Files. Computer Run Log Book files are maintained by the MIS Staff to document authorized requests for computer runs at the Central Bureau Computer facility. Separate books are maintained for runs involving such systems as EPIS and Profiles, and for miscellaneous computer accounts, and the like.

Retention Period. Destroy when 3 years old.

28. MIS Systems Data Bases - Data Sets. Certain of the various data bases or data sets involved in the MIS management or financial and personnel management reporting systems are maintained on the hard disks of the PC's of the MIS staff with diskette back up as required, such as the data base for the Project Planning and Management Control System of the MIS Staff, maintained under Primavera and RAMIS program packages, or data sets for various system development or enhancement projects.

The voluminous data bases, however, for the various MIS management, financial and personnel management systems under the purview of the MIS Staff are maintained at the Central Bureau Computer facility by the Division of Management Information Systems of OTOR. These include such systems as: the Employee Position Information System, the Operating Information Budget System, the Financial Profile System, the Resource Availability System, the Labor Market Information Payment System, the Staff Utilization System, the Accounting Input System, the MIS Umbrella System and Accounting Code Manual, the Printing Information System, the Equipment and Procurement Information Systems and such other MIS Systems as required.

These data bases and related data sets are typically maintained on disks at the Central Bureau Computer Facility with periodic tape back up.

The MIS Staff has overall responsibility for development, debugging, and, as required, enhancement of these Systems, some of which are the operating responsibility of other Staff offices, such as the Division of Financial Planning and Management, the Office of Publications, the Division of Personnel

and Organization Management, or the Division of Administrative Services, and the like.

Retention Period:

 Disk Data Bases - Data Sets. Scratch when superseded or when no longer needed for current business, as appropriate.

29. Technical Reference Files. These are extra copies, printed materials, copies of articles from professional magazines, various periodicals, copies of instructional manuals and the like maintained by MIS Staff personnel covering their assigned areas of work as well as computerized operations, and statistical procedures and methodology, and the like.

Retention Period. Review files at least annually to identify obsolete materials. Destroy when superseded, obsoleted, or no longer needed for current business as appropriate.

30. MIS Program Intermediate Machine Processing Files. Consists of intermediate processing disk, tape, or diskette files pertaining to the development or maintenance of various MIS program systems or other MIS Staff projects. Such files are defined by General Records Schedule 20, and include work files, test files, input source files, intermediate input/output files, valid transaction files, and the like covering the machine readable records not specifically listed under other schedule items for the MIS Staff or the MIS Division of OTOR.

Retention Period. Apply GRS 20, Item 1 as appropriate.

OFFICE OF FIELD OPERATIONS
BUREAU OF LABOR STATISTICS

a. Mission

To provide support for all Bureau program and project offices by ensuring timely collection of accurate and quality data by Bureau personnel working in Bureau Regional Offices, and by state government personnel (contractors); to direct the collection activities of Regional Offices; to provide program related training (i.e., instruct data collectors on the purpose and objectives of programs serviced and techniques associated with acquiring data); and provide other administrative support to field components.

b. Functions

- (1) Provides leadership and policy direction to the Bureau's Regional Offices and provides appropriate national office supervision to the Regional Offices on administrative matters related to planning, scheduling, and monitoring data collection; budgeting; staff allocation; and related administrative matters.
- (2) Serves as a conduit for Regional Offices on questions/answers going to or needed from project offices on professional concerns related to statistics and/or economics.
- (3) Participates with the project and program offices in the planning of all field collection programs by advising on "workability" of proposed methods, advising on how realistic are the proposed timetables, etc.
- (4) Provides direction to the Division of Field Collection Activities and the Division of Cooperative Program Coordination in planning, scheduling, and controlling administrative aspects of work done by BLS' regional staff and state government (contractor) personnel.
- (5) Develops consolidated regional estimates of workload and resources required for regional and state programs. Reviews proposed staffing patterns and requests for funds from the Regional Offices and makes recommendations on resource allocation. Assists Regional Commissioners in estimating budget needs for long-range proposals.
- (6) In accordance with program plans and overall Bureau priorities, allocates resources to the regions and monitors their use.
- (7) Evaluates performance of Regional Offices; reviews activities to ensure that they are carried out in cost effective manner; performs program analysis/quality assurance for data collection activity.

- (8) Determines and evaluates training needs of Office of Field Operations staff, provides training on data collection methods for those who need it.
- (9) Assists the public relations program in the Regional Offices by emphasizing and encouraging the extension of BLS services to labor, industry, and community organizations.
- (10) Provides, as requested, administrative services and ensures logistic support for Bureau conferences and meetings.
- (11) Serves on the Bureau's Executive Committee.

OFFICE OF THE ASSOCIATE COMMISSIONER
FOR FIELD OPERATIONS

The files of the Office of the Associate Commissioner for Field Operations reflect the direction and coordination by the Office of Field Operations of the activities of the BLS Regional Offices and Area Offices in providing support to all Bureau program and project offices as needed.

Currently, the principal files of the Associate Commissioner are in hard copy. Work is under way, however, at the facilities of the Bureau's Local Area Network (LAN) System, gradually to install machine-readable recordings of the correspondence type of files currently maintained in hard copy by the Associate Commissioner reflecting Headquarters-Regional relationships.

RECORDS OF THE
OFFICE OF THE ASSOCIATE COMMISSIONER
FOR FIELD OPERATIONS (OFO)

31. OFO Bureau Correspondence File. This file is in three segments. One is for incoming and outgoing internal memoranda, correspondence and related documents reflecting, primarily, communications to or from various organizational units comprising the BLS national office. Certain folders of this alphabetically arranged file segment contain copies of memoranda sent from individual regions to various BLS program offices through OFO, or copies of memoranda sent to BLS Regional Offices by BLS program offices through OFO.

Also included are folders for Department of Labor, BRAC, LRAC, and the like.

The second file segment covers internal correspondence from or to the Associate Commissioner's office involving the various organizational subordinate units of OFO.

The third file segment, labelled "Reports" contains such materials as Federal/State memoranda from or to OFO from states or regions; Bureau of National Affairs memoranda; monthly or weekly progress reports received by the Associate Commissioner from subordinate organizational units of OFO, or copies of monthly reports of program BLS offices; as well as morning reports received from the Office of Publications.

The file is broken annually.^{1/} The current file covers the period 1982 to date and 2 cubic feet a year are accreted.

Retention Period. Permanent. Break file annually. Transfer to the WNRC when 5 years old. Offer for transfer to the National Archives of the United States in blocks of 10 years when the latest record is 20 years old.

32. OFO Regional Correspondence File. File consists of incoming and outgoing memoranda or communications to or from the OFO Associate Commissioner's Office involving communications with individual BLS Regional Offices, typically addressed to the Regional Commissioner. The file is arranged by BLS regions and within regions by the particular BLS program involved, such as

^{1/} After the LAN System of electronic mail and filing becomes fully operational involving the OFO Associate Commissioner's Office and the Regional Commissioner's offices as well as the top officials of the BLS national offices, certain hard copy records of this file, as well as of the next three files of the Office of the OFO Associate Commissioner -- Schedule Item Numbers 31 and 32, and 33 may no longer be in hard copy format but may be electronically communicated and filed.

(See Item 50 of this schedule for a description of the Regional - Washington Office LAN electronic mail and file system now being implemented.)

Administration, Economic Analysis and Information, Federal/State, Operations-Wages, Operations-Prices, etc.

The file is broken annually. The current file covers the period 1982 to date and one cubic foot a year is accreted.

Retention Period. Permanent. Break file annually. Transfer to the WNRC when 5 years old. Offer for transfer to the National Archives of the United States in 10-year blocks when the latest record is 20 years old.

33. OFO Regional Commissioner File. Consists of copies of teletypes or memoranda addressed to all BLS Regional Commissioners from the OFO Associate Commissioner. These reflect the overall direction by the Associate Commissioner over the BLS Regional Offices in scheduling and managing the BLS Regional Offices complex, primarily in carrying out the data collection and Federal/State cooperative activities involved in BLS programs.

The file is broken annually. The current file covers the period 1984 to date and one cubic foot a year is accreted.

Retention Period. Permanent. Break file annually. Transfer to the WNRC when 5 years old. Offer for transfer to the National Archives of the United States in 10-year blocks when the latest record is 20 years old.

34. OFO Administrative Management Subject File. Consists of correspondence and related documents of the Office of the Associate Commissioner pertaining to the management of the Regional Offices as well as the management of OFO and the BLS.

Unlike the first three files described herein of this office, the Subject file is not broken annually. The file is currently in two segments. One segment covers the period of 1979 to date; an earlier segment has records dating back as far as 1971, although there are some folders dated later than 1979 in the second segment, with gaps in data coverage.

The files cover such subjects as: Awards, Confidentiality, Budget, International Assignments, Merit Pay, Organization-Reorganization, Regional Reorganization, Training Agreements, LMI-OSH Grant Management, Meetings covering management - Organizational Reviews, Science Management Reports, Automation Task Group, Organizational Responsibilities, and Federal/State Memoranda of Understanding.

In effect, this file contains selected materials believed to have precedent - policy implications.

- a. Records Dated before 1979 (Historical File).
Permanent. Transfer to the WNRC in 1990.
Transfer to the National Archives in 2000.
- b. Records Dated 1979 and Later. *Break file annually*
Transfer to the WNRC when 5 years old. Destroy when 10 years old.

35. Associate Commissioner Meeting - Conference File. This is a separate file maintained by the Associate Commissioner to reflect attendance at meetings - conferences of interest to her.

Many of the meetings were OFO-sponsored meetings or conferences involving Regional Commissioners or other Regional Office supervisors or managers. Some of the files involve attendance of the OFO Associate Commissioner at various meetings - conferences of an economic or statistical nature, and at which a presentation may have been made.

The meeting files cover such matters as agendas, summaries of events, presentation notes, correspondence, and reports, and the like.

Retention Period. *Transfer to the WARC when 5 years old.*
 Destroy when 10 years old.

36. Internal Housekeeping - Personnel Files, Associate Commissioner. Consist of personnel name files involving Associate Commissioner's copies of correspondence and form records involving the Regional Commissioners and Assistant Regional Commissioners at the BLS Regional Offices as well as national office OFO employees charged to the Associate Commissioner's cost center.

Also included are internal office housekeeping correspondence; extra copy and form records involving such administrative matters as Associate Commissioner's travel vouchers, logs governing issuance and distribution of the Associate Commissioner's Regional memoranda, logs governing local travel and bus tokens, space management files, and the like.

Retention Period.

- a. Personnel Name Files. Destroy one year after separation or transfer of employees concerned.
- b. Regional Commissioner's Folders. Destroy when 2 years old or when no longer needed for current business. (GRS 23, Item 1).
- c. Other Files. Destroy when 3 years old.

37. Associate Commissioner's Chronological Reading File. Consists of copies of correspondence and related records prepared in OFO or signed by the Associate Commissioner; filed in binders in date order.

Retention Period. *Transfer to the WARC when 3 years old.*
 Destroy when 5 years old.

38. Word Processing Diskette Files, Associate Commissioner's Office. Consist of diskettes used in the Xerox word processing system used in the secretarial process of preparing documents in the Office of the Associate Commissioner.

Retention Period. Scratch diskettes when no longer needed for current business.

ADMINISTRATIVE STAFF
OFFICE OF FIELD OPERATIONS

- a. Mission. To provide the OFO Associate Commissioner with Administrative support.
- b. Functions
 - (1) Controls, monitors, ensures correctness of, and otherwise clears personnel actions to Bureau Administrative personnel. Monitors Regional personnel issues, consolidates merit pay proposals for national office and field staff, etc.
 - (2) Consolidates, monitors expenditures, and assists in development of OFO regional and national offices' budgets.
 - (3) Interfaces with Office of Technology and Operations Review on data transmission, telephone, and other such concerns of OFO regional and national offices.
 - (4) Interfaces with Office of Administration on space management and other such concerns of OFO regional and national offices.
 - (5) Secures printing and forms design services for OFO regional and national offices.

**RECORDS OF THE
ADMINISTRATIVE STAFF
OFFICE OF FIELD OPERATIONS**

The Administrative Staff is headed by an Administrative Officer. The staff works closely with the Office of the Associate Commissioner for Field Operations in supporting the activities of the office.

There are two separate collections of files maintained by the Administrative Staff. One collection is maintained contiguously to the files of the Associate Commissioner; the other collection is maintained apart, in the Forms Design Unit, which operates as a separate organizational subdivision.

39. National Office Correspondence File. Consists of incoming and copies of outgoing correspondence maintained by the Administrative Officer involving his copies of OFO correspondence to or from various organizational units of the national BLS office. In effect, this file is somewhat duplicative of the Bureau Correspondence File of the Office of the Associate Commissioner. The file is arranged by organizational subdivisions of BLS.

Retention Period. Destroy when 5 years old.

40. Regional Office Correspondence File. Consists of Administrative Officer's copies of correspondence to or from the Regional Offices involving OFO direction or coordination of Regional Office activities.

The file is arranged by Regional Offices and by subordinate organizational units thereunder. The file duplicates to some extent the Regional Correspondence File of the Office of the Associate Commissioner OFO (see Item No. 2.).

Retention Period. Destroy when 5 years old.

41. Regional Grievance Files. Consist of the Administrative Officer's copies of records involving Regional Office personnel grievances or appeals. Arranged by individual case.

Retention Period. Destroy 3 years after case is closed. (GRS 1, Item 30(a))

42. Administrative and Program Subject File. Consists of subjectively filed correspondence and related records of the Administrative Staff covering both internal housekeeping and program subject matters involving OFO direction and coordination of BLS Regional operations. The alphabetical file covers the various statistical BLS programs for which Regional Offices collect or analyze data, as well as a range of internal housekeeping activities involving the BLS Regional Offices.

Included in the file are such subject captions as Field Office Audits, Automobiles, Computer Bills, Contacts with State Agencies, Federal/State Cooperation, Flexitime, FOIA, GSA Car Usage, Mail, Microfiche, Permanent Positions, separate folders for each region, State Departments of Labor, Space, TDY-Travel, and personnel name files for field operations staff.

Retention Period. Break file every 5 years and bring forward active materials to the current files as needed.

- a. Destroy Program Records when 10 years old or when no longer needed for current business, whichever is later.
- b. Destroy Administrative files when 5 years old except that personnel name files shall be destroyed one year after termination or separation of employee, as applicable.

43. Regional Office Periodic Report Files. The files consist of two types of monthly reports made to OFO by the BLS Regional Offices. One type of these chronologically filed reports is a statistical report on Economic Analysis and Information (EA & I) activities within each region covering telephone and written inquiries as well as distribution activities. Summaries of these reports from 1978 to date for all regions are included. The other report is from the Regional Commissioners, and it provides a narrative statement on monthly progress of all Regional Office activities.

Retention Period.

- a. EA & I Individual Region Reports. Destroy when 5 years old.
- b. EA & I All Region Summary Reports and Monthly Regional Commissioner Narrative Progress Reports. Permanent. Transfer to the WNRC when 10 years old. Offer for transfer to the Archives of United States in blocks of 10 years when the latest record is 20 years old.

Transfer to the WNRC when - 3 years old.

44. BLS File on Participation in the North American Conference on Labor Statistics. The file, which is in two segments, reflects the BLS participation and leadership in the annual North American Conference on Labor Statistics (NACLAS).

The records are arranged by year and city of the conferences that were held. The first segment of the file covers conferences from the period 1949-1958; and the conference folders contain such materials as conference summaries, copies of BLS personnel presentations, agendas, correspondence, and notes.

The second segment covers the period 1974-1981, and the folders contain many letters signed by the BLS Commissioner, materials on site selection, agendas, notes, speeches, and conference summaries.

- a. Records for the period 1949-58. Permanent. Transfer to the WNRC. Transfer to the National Archives in 1996.
- b. Records dated after 1958. Transfer to the WNRC when 5 years old. Destroy when 10 years old.

45. Office Copy of OSH-SDS Federal/State Numbered Memoranda. Consists of the office copy of the numbered Federal/State OSH-SDS program numbered memoranda, including advance copies, sent through OFO to the states and Regional Offices. Record copy is maintained by OSHS, which prepares these memoranda. File is maintained in 3-ring binders.

Retention Period. Destroy when no longer needed for current business.

46. Office Copies of BLS Headquarters Regional Office Releases. Consist of copies of Area Wage, Price, Employment, OSH, and other program releases issued by national or Regional Offices, maintained for reference distribution purposes.

Retention Period. Destroy when 2 years old, or when no longer needed for current business, whichever is later.

47. Mailing List Records for Federal/State Memoranda. Consist of labels and card - correspondence records reflecting mailing lists for distribution of Federal/State memoranda.

Retention Period. Destroy when 3 months old, or when cancelled or revised, as appropriate. (GRS Schedule ~~13, Item 4.~~)

48. Regional Office Computer Usage Accounting Records. Consist of binders containing copies of monthly billing records obtained from the central Bureau computer facility covering office and Regional Office usage of computer facilities.

Retention Period. Destroy when 3 years old.

49. Regional Budget Compilation Files. The OFO Administrative Staff receives budget estimates from individual regions and compiles summary budget estimates as required for presentation to the central BLS Budget Office covering all regions as part of the budget preparation process. These are, in effect, working files.

Retention Period. Destroy when 3 years old.

50. Associate Commissioner's LAN System Electronic Mail-Record Files. While the LAN (Local Area Network) System is a Bureau-wide system of the national BLS office, the OFO Associate Commissioner has a special interest in the Regional Commissioner - OFO relationship included in the system.

At the time of this writing, this segment of the system involves electronic mail between the Regional Commissioners and the Office of the OFO Associate Commissioner, using the magnetic disk storage of the central Bureau file server as an initial point of entry. With access to the assigned space of OFO on the central LAN file server, electronic mail can be received using a PC computer in the Associate Commissioner's office. Such mail may be not only from the Regional Offices, but also from top officials of the Bureau's national office.

Selected documents received via electronic mail can be placed on file on the file server disk, or in the OFO Associate Commissioner's Office PC disk, or on diskettes of the PC system.

It is planned this fiscal year to expand the system to include more formal, established electronic files, on such magnetic media, of a similar type described in the Regional Office Records Schedule, Item 4, which are attached as an example of LAN System electronic files.

Retention Period. Electronic files of the Office of the OFO Associate Commissioner, when established, will have similar retention periods to their hard copy equivalents described in Items 31, 32, and 33 of the Office of the OFO Associate Commissioner Schedule. (Magnetically recorded records that are retained for more than five years on archival tapes or diskettes will be regenerated at 5-year intervals to ensure readability.)

EXAMPLE OF LAN SYSTEM FILES AT A REGIONAL OFFICE

4. Regional Commissioner-Assistant Regional Commissioner's LAN-Disk-Tape Files. File may consist of the following types of top level officials' files on the LAN system's disks or tapes.

File (1)

The Regional Commissioner's and the Assistant Regional Commissioner's individual chronological files from the electronic mail system including chronologically arranged, screened incoming messages from within the Regional Office or from OFON headquarters from each official's incoming mailbox or screened copies of outgoing messages prepared on the terminals of each of the top Regional Officials and arranged chronologically.

File (2)

A centralized Regional Office top official (RC-ARC's) chronological file containing screened incoming and outgoing messages, chronologically arranged, containing copies from the individual top officials' chronological files (File 1).

File (3)

Individual top officials' (RC-ARC's) program and administrative subject files, containing screened copies of incoming and outgoing subjectively filed documents originally placed in the private volumes of each of these officials.

File (4)

A centralized Regional Office top official program and administrative subject file containing copies of subjectively filed documents from the public volumes of each of these top officials transferred to this centralized public volume file for the Regional Office.

(Files 1 through 4 are on the fixed disk of the LAN System file server and should be transferred to system tape cassettes at 6-month intervals.)

Archives Tape Cassette files for each of the above individual top officials or the centralized Regional Office files listed as Files 1 through 4. Such Archives tape cassette files should be created by transfers from the disk to the system's tape cassettes at 6-month intervals if space on the disk is adequate, or at regular lesser intervals if disk space problems occur.

Retention Periods for these Tape Cassette Archives Files of the LAN System.

- a. File 1. (Individual Top Officials' Chronological Files) Scratch when 3 years old.
- b. File 2. (Centralized Regional Office Chronological Files) Scratch when 5 years old.

- c. File 3. (Top Officials' Individual Program and Administrative Subject Files) Scratch when 10 years old.
- d. File 4. (Centralized Top Officials' Program and Administrative Subject Files) Scratch when 15 years old.

Note: Tapes for files 3 and 4 should be regenerated at 5-year intervals to avoid drop-outs or other diminution of the data.

RECORDS OF
FORMS DESIGN UNIT
ADMINISTRATIVE STAFF
OFFICE OF FIELD OPERATIONS

51. Public Use - Internal BLS Forms Control Files. Consist of large envelopes maintained numerically in flat files containing the camera-ready copy or a print, or negative for BLS public use forms and for internal BLS SO, ADM, or OAM forms. These files are used for revision or reproduction of forms as required.

As of 1986, this hard copy reproduction file has largely been replaced by machine-readable diskette file for forms created by GPO Compugraphics Service for BLS public use or any complex form. In addition internal BLS forms, when revised, are now being maintained on the Department of Labor Xerox 8700 System, being recorded by form number.

Retention Period. Destroy when related form is discontinued, superseded, or cancelled. (GRS 16, Item ~~54~~)

52. Machine-Readable BLS Forms Control File. Since 1986, the Forms Design Unit has been using the GPO Compugraphics Forms Design Service for the design and composition of forms. In lieu of camera-ready copy, the Forms Design Unit obtains diskettes from GPO containing the design data for many individual forms per diskette. For example, one diskette contains the revised forms design data for the entire 790 (CES) and OSHS programs. Similarly revised forms for all BLS programs are now being maintained on diskettes. Unless revisions are very complex, the original floppy disk can be used and revised as required for preparing revisions.

Retention Period. Scratch as needed when related forms are discontinued, superseded, or cancelled. (GRS 16, Item ~~54~~.)

53. Unit Printing Requisition and Log Files. The Forms Design Unit maintains a requisition file consisting of copies of the printing requisitions and a hard copy of the resulting printed document for all types of forms or graphic work that is handled by the Unit. The file is broken on a fiscal year basis. One exception to this file is the separate requisition file maintained for mechanical pin-feed forms.

Log books in binders are also maintained as control records for the printing requisition file.

Record copies of requisitions are maintained by the central Bureau Administrative offices.

Retention Period. Destroy when 3 years old. (GRS 13/2a)

54. Requisition Print File for Mechanical Pin-Feed Forms. A separate file is maintained for mechanical pin-feed form requisitions and prints similar to the Unit file described in the preceding item. Sometimes negatives may be included for contractor-prepared pin-feed forms.

Retention Period. Destroy when 3 years old.

55. Inactive BLS Forms Print File. An inactive file has been maintained in binders consisting of a copy of each printed form handled by the Forms Design Unit. This file covers only the period 1971-1980, after which it was no longer actively maintained.

The file is arranged by the particular BLS program concerned.

Retention Period. Destroy when no longer needed for current business. (GRS 16/3a)

56. Graphics Printing Control Files. The Unit creates and designs graphics in finished form suitable for reproduction. Specific products include covers for manuals, art, charts, graphs, and illustrations for presentations, publications, and the like.

The file consists of large envelopes in flat file drawers containing camera-ready copy or prints, or negatives for each graphics job undertaken.

The file is arranged by program.

Retention Period. Destroy when no longer needed for current business or when revised or superseded, as appropriate. (GRS 21/6)

57. Fragmentary Photographic Print Files. Copies of photographic prints have been received for storage at the Forms Design Unit from various program offices of the Bureau. There is no control over which photographs should be stored by the Unit. In a few cases, for example, for some Bureau composite photographs, negatives of the photographs have been obtained. Many photographs may be difficult to interpret or identify.

Retention Period. Destroy when no longer needed for current business.

BRANCH OF PROGRAM RELATED TRAINING
OFFICE OF FIELD OPERATIONS

- a. Mission. To develop, plan, and direct a program for the training of Bureau and state government (contractor) personnel on Bureau programs, data collection methods, and other related technical and program related training, and to coordinate, as assigned, Bureau conferences and meetings.
- b. Functions
- (1) Schedules, secures advantageous room rates and otherwise coordinates administrative aspects of technical, managerial, and other Bureau conferences and meetings, as requested.
 - (2) Designs, develops, conducts, and evaluates a system of program related training courses for Bureau, state government, and affiliated personnel who collect, process, analyze, and use Bureau data.
 - (3) Designs, develops, and evaluates self-instructional training materials, courses, and manuals used by regional office personnel.
 - (4) Reviews data collection instructional manuals in developing training strategies, courses, and support materials for Bureau program.
 - (5) Assists program offices in the development of survey techniques and manuals by reviewing and commenting on "workability" in the field of proposed data collection methods and requirements and by providing estimates of training needs and costs to implement them.
 - (6) Coordinates, with appropriate outside training sources, to secure the career development, ADP, and other non-program related training of the Office of Field Operations staff.

RECORDS OF THE
BRANCH OF PROGRAM RELATED TRAINING
OFFICE OF FIELD OPERATIONS

General

In carrying out the responsibilities assigned by the foregoing mission and functions statement, the BPRT is involved annually in upwards of 200 training courses, conferences, and meetings. For simplicity, the term "courses" will be used generically to refer to such training courses, conferences, and meetings. The course audiences may include not only BLS field and Washington national (headquarters) offices personnel, but also participants from state governments who are involved in BLS Federal/State Cooperative (statistical) Programs.

Developing Training

Greater than 50% of BPRT efforts are spent in developing technically accurate materials for those courses presented by BPRT or Regional staff. As well as incorporating accepted adult education practices, this means maintaining a high degree of technical proficiency on the programs involved. This technical proficiency reaches beyond data collection procedures to all parts of the programs including sampling, economic theory, national and regional office processes, systems impact, and publications. Changes in these areas are reviewed from a training viewpoint.

To maintain this proficiency, BPRT trainers are actively involved in ongoing participation in inter-office task forces usually led by representatives of the BLS program office supported. The trainers' responsibilities on such task forces often include providing a field perspective to the group and identifying any potential problems for implementing proposed changes in relationship to existing procedures. In keeping with this role, trainers are also involved in review and clarification as other offices within BLS are writing field procedures. To be assured of keeping current on application of procedures in "real world" situations, trainers also provide supplemental data collection support to the regional offices when needed.

Managing Conference Logistics

Trainers are required to select and arrange for the most cost effective site for their conferences. This involves working with hotel sales, and catering. BPRT provides BLS with meeting support for several non-training meetings as well as the planned training calendar.

The Branch also provides a consistent method of conference administration. A system of course announcements, nomination procedures, and coordination of regional office training participation is in place.

Conducting Training

The best known function of BPRT is actual classroom training. A full calendar of program related courses is offered to Regional Office staff. More and more frequently national office staff are also being trained on current or changing procedures. Courses are conducted at a variety of locations nationwide. To improve training efforts, evaluation is conducted continually.

Internal Branch Organization

The Branch staff are organized into: the immediate office of the Branch Chief, supported by a Special Projects staff; and three Training Teams that support specified BLS statistical programs, namely: (1) CPI Programs; (2) Wage Programs; and (3) Industrial Price/Cooperative Programs. Records pertaining to the direction and operation of such statistical programs are covered in other Record Schedules.

58. Branch Chief Program and Administrative Subject Files. Maintained by the Secretary to the Branch Chief, these files concern direction of the programs and internal management activities of the Branch. They pertain to such topics (folder labels) as ADP Training, Branch Staff Memos, Flexitime, Guidelines for Training Sessions, Performance Appraisals, Training of Trainers, Budget, Conference Cost Estimates, Federal/State Programs (e.g., LAUS and LMI), Price Programs, Wage Programs, Computer Training, Progress Reports, Personnel, Time and Leave, and the like. Included are such materials as: copies of inter-BLS headquarters offices correspondence; copies of communications with Regional Offices; correspondence with sources of services, equipment, and supplies; office copies of local transportation vouchers; office copies of requisitions; meetings/conferences schedules; equipment brochures; Branch internal procedures; training authorizations; and the like.

Copies of important correspondence prepared in the Branch will also be forwarded to the Associate Commissioner's files.

Retention Period. Break files every 5 years and bring active materials forward to new files as required. Destroy inactive materials when latest record is 5 years old or when no longer needed, whichever is sooner.

59. Training Program Expenditure Files. Include records of expenditure (transactions) charges to various BLS programs for which BPRT provides training. Consist of such materials as logs of expenditure transactions and copies of transaction-type documents such as employee travel authorizations and vouchers; requisitions for equipment, supplies, and services; and machine printout listings from the BLS MIS showing transaction data and fund status.

These files are arranged by fiscal year and thereunder by BLS program.

Record files are maintained by the Office of Budget.

Retention Period. Destroy when 2 years old. (Keep current year plus 2 previous years.) GRS 7/4b

*60. Branch Personnel Name Files. Consist of office copies of personnel name files of present and former Branch employees, containing such documents as notification of personnel actions; requests for personnel actions; resumes; performance appraisals; training certificates; and correspondence. Official files are maintained at the Division of Personnel Organization and Management. Such records are covered by the Privacy Act.

Retention Period. Destroy 1 year after transfer or separation of employee.

*61. Branch Time and Attendance Files. Consist of office copies of time and attendance documents such as bi-weekly time cards and related flexitime records pertaining to Branch personnel. Maintained by Branch and Team Timekeepers.

Retention Period. Destroy after GAO Audit or when 3 years old, whichever is sooner (GRS 2, Item 3(b)).

62. Hotel Brochures Reference Files. The Branch is involved in making arrangements for some 200 meetings, conferences, and training sessions annually. As an information source, files are maintained of brochures and other materials regarding meeting and lodging facilities in likely locations.

Retention Period. Destroy when replaced by updated material, or when obsolete, or when no longer needed for current business, as appropriate.

63. Non-Training Conferences/Meetings Project Files. Frequently, the Branch is called on to arrange for BLS meetings and conferences that do not directly provide training. The Branch Special Projects Staff maintains project files pertaining to arrangements with providers of accommodations for non-training meetings/conferences throughout the United States.

The files contain such items as copies of preliminary correspondence with providers (such as hotels), copies of requisitions sent to the BLS Contracting Officer (Division of Administrative Services) to issue a purchase order, brochures, meeting agenda, work sheets, long hand notes, etc. Typically, a project folder(s) is maintained for each meeting/conference.

Retention Period. Destroy when no longer needed for current business.

64. Files of Instruction Materials. Files of instruction materials for the courses for which the BPRT is responsible. Ordinarily, up-to-date master sets are maintained by designated training specialists.

Usually, the materials are consolidated into course instructor guides. The contents of these files, arranged by course, may include such items as lecture notes; copies of class exercises, problems, etc., and other handouts; audio visual aids such as overhead projector transparencies, 35mm slides, video cassettes, and 16mm film; and the like. Some of the audio visual aids are produced by BLS and some purchased from private sources.

In addition to the master sets, other copies may be maintained for classroom use as well as for reference purposes.

As mentioned earlier, the training courses provide vehicles for instructing BLS personnel in the field as well as in headquarters offices in the application of BLS policies and procedures that are published in detail in such documents as BLS data collection manuals and technical memoranda. The training courses may also be presented to state government employees who are involved in data collection and processing activities concerning BLS statistical programs.

Such documents as the BLS data collection manuals and technical memoranda, which form the bases for these instructional materials, are covered in the Record Schedules for the statistical programs involved, with provisions for record copies to be designated as permanent and subsequently offered to the National Archives.

Self-instruction workbooks are developed by the Branch. See the following Item 65 of this Record Schedule.

Retention Period.

- a. Instruction Materials Master Set Records. Destroy 5 years after being superseded or 5 years after course is discontinued, as appropriate.
- b. Other copies. Destroy when no longer needed for current business.

65. Record Copy of Self-Instruction Workbooks. The Branch of Program Related Training (BPRT) develops self-instruction materials such as workbooks that are, primarily, for use of personnel participating in data collection activities for BLS statistical programs. Examples of such documents are the Standard Industry Classification (SIC) Coding Workbook, the Consumer Price Index Natural Gas Self-Instruction Workbook, and the Area Wage Programmed Instruction.

These issuances provide detailed instructions for BLS field employees and are also available for use of state government personnel who participate in BLS Federal/State Cooperative Programs such as the Occupational Safety and Health Statistics and Employment and Unemployment Statistics.

These workbooks, or manuals, supplement other detailed procedural manuals and technical memoranda for the statistical programs concerned. They have been prepared by the BPRT staff and coordinated with the BLS program office concerned.

Originated at varying dates, these self-instruction documents are updated as required. As of this writing, the volume of record copies on hand totals less than one cubic foot and annual accretion is negligible. Arranged by statistical program.

Retention Period.

- a. Master Set of Self-Instruction Workbooks/Issuances. Destroy 5 years after being superseded or 5 years after course is discontinued, as appropriate.

- b. All other Copies, of Self-Instruction Workbooks/Issuances.
Destroy when no longer needed for current business.

66. Course (and Conference) Folder Files. For each training course, conference, or other meeting for which the Branch makes arrangements and/or conducts training, a course case folder is prepared. Typically, these files may include such items as a list of participants/students, participant background information sheets, course evaluation sheets (by the participants), instructor's summary evaluation of involvement by the participants, results of tests (when given), course announcements, agenda, copies of hotel arrangement letters, facilities brochures, instructor comments/observations, and the like.

Maintained by each Training Team for courses conducted by its personnel, the files serve as valuable reference sources in planning training sessions and developing or revising training materials.

Retention Period. Destroy when 5 years old or when no longer needed for current business, whichever is later (GRS 1/29a(1)).

67. Training Teams Correspondence Files. Maintained by each program Training Team, these files consist primarily of such materials as extra copies of correspondence (copies are also filed in the Branch Chief Program and Administrative Subject Files), course agenda, course announcements, and the like pertaining to the Team activities. Included are copies of "Hotel Letters" pertaining to logistical arrangements with providers of such services.

Retention Period. Destroy when 5 years old or when no longer needed for current business, whichever is later.

68. Course Announcement Files. Consist of reference copies of training course announcements maintained by some BPRT personnel, such as Training Team Secretaries or Training Technicians. Course announcements are also routinely placed in the Course Folder Files (Item 66).

Retention Period. Destroy when no longer needed for current business.

69. Course Development/Maintenance Background Technical Reference and Working Files. In carrying out their duties, such as designing and revising training courses, conducting training, participating in BLS inter-office planning task forces, developing training schedules, and making logistical arrangements for training classes and other meetings, training specialists and other Branch personnel at all levels accumulate background source data files typically relating to their assigned areas of responsibility or to training technology in general.

These files may include such materials as extra copies of data collection manuals, technical memoranda, correspondence, or other detailed procedural guidance issued to BLS Regional Offices or headquarters offices. Included also may be such items as extra copies of other correspondence, published articles, news releases, drafts, professional periodicals, issuances, or other materials from other government or from private sources, notes, working papers, and the like.

This file item does not cover those source data or other files that are listed as specific items in this Record Schedule.

Retention Period. Review files at least once a year to identify disposable materials. Destroy when superseded, obsolete, or no longer needed for current business.

70. Training Team Records of Course Participants. Some Branch Training Teams maintain records for readily identifying participants of courses conducted or managed by the Team. These files may include lists of participants by course, or a manual register (supplemented by word processing media files) of BLS field personnel who participated in the Team's courses. Such records are in addition to, and separate from, the Course Folder Files (Item 66 of this Record Schedule).

Retention Period. Destroy when 5 years old or when no longer needed for current business, whichever is sooner (GRS 1, Item 29(a)(1)).

71. Training Team Administrative Subject Files. Consist of small administrative files maintained by some BPRT Training Teams, including such materials as weekly plans of Team members, budgeting/cost notes and correspondence, copies of travel authorizations, copies of requisitions, team work plans, individual employee weekly report of activities accomplished and projected, and the like.

Retention Period. Destroy when 3 years old, or when no longer needed for current business, whichever is sooner (GRS 1, Item 29(a)(2)).

72. Word Processing Media Files. Diskettes or other word processing storage media used in preparing textual, tabular, or other hard copy documents such as correspondence, training materials, course announcements, course agenda, and the like.

- a. Used to produce hard copy maintained in organized files. Delete when no longer needed to create a hard copy (GRS 23, Item 2(a)).
- b. Maintained only in electronic form. Delete after the expiration of the retention period authorized for the hard copy by the GRS or a NARA approved SF-115 (GRS 23, Item 2(b)).

73. BPRT ETHERNET System Machine Readable Files. The Branch, via terminal, accesses a central computer facility maintained by the Office of Technology and Operations Review (OTOR). This ETHERNET System is used to generate hard copies of graphics and textual materials related to training. For graphics work, the ETHERNET System uses Xerox STAR software.

Machine readable files are maintained on disk at the central facility by OTOR.

Retention Period. Scratch when no longer needed for current business.

74. BPRT LAN System Machine Readable Files. The BPRT is connected from in-Branch personal computers to the BLS-wide LAN System described under Item 50, the Associate Commissioner (for OFO) LAN System Electronic Mail Files. As of this writing, the System was being phased in. The Branch expects to use the BLS LAN System for electronic mail connection with Regional Offices for such purposes as course announcements and other training-related matters.

In addition, it is planned to place training materials, as practicable, on the LAN System storage disks (see Item 64, Files of Course Instruction Materials).

The LAN System machine readable files for the BPRT are maintained on assigned disk storage space of the central file server.

Retention Period.

- a. Electronic Files of Course Instruction Materials. When established, will have similar retention periods to their hard copy equivalents described in Item 64, Files of Course Instruction Materials. (Magnetically recorded records that are retained for more than 5 years, on archival tapes or diskettes, will be regenerated at 5-year intervals to ensure readability.)
- b. Other BPRT LAN System Electronics Files. Scratch, or otherwise destroy, when 5 years old.

DIVISION OF INTERNATIONAL TRAINING
OFFICE OF PRODUCTIVITY AND TECHNOLOGY

Functions

- (1) Develops and conducts Washington-based seminars for economists, statisticians, managers of labor statistics programs, and users from developing countries.
- (2) Develops and conducts specialized regional seminars for same groups in Asia, Africa, and Latin America.
- (3) Provides courses in basic labor statistics techniques for foreign participants.
- (4) Develops and administers programs for short-term visitors, ranging from one day to one month.
- (5) Develops labor statistics manuals for use by statisticians in underdeveloped countries and by American consultants serving in these countries.
- (6) Coordinates recruitment and selection of BLS staff for overseas technical assistance and training assignments.
- (7) Participates in activities concerned with international agencies and foreign organizations, and with ILAB, AID, and other U.S. agencies, in technical assistance programs.

RECORDS OF THE
DIVISION OF INTERNATIONAL TRAINING
OFFICE OF PRODUCTIVITY AND TECHNOLOGY

The Bureau of Labor Statistics has been providing training to persons of other countries since 1946. Each year, the Bureau's International Training Center, operated by the Division of International Training (DIT), conducts in Washington about 10 seminars of three to eight weeks' duration for such persons. In Calendar Year 1987, eleven seminars were scheduled.

The seminars address applied statistics, analysis, and uses, as well as data collection and processing techniques. As of this writing, most of the participants were experienced economists, statisticians, and analysts. Governments, universities, trade unions, private employers, and employer federations have been represented.

In developing and conducting seminars, the DIT staff perform a variety of duties. In addition to the logistical and administrative arrangements, they develop and maintain training materials and obtain guest lecturers. The material presented in a seminar does not address U.S. Government foreign policy, but it relies largely, but not entirely, on material published by the Bureau or other government or private sources.

In addition to the Washington-based seminars, the BLS conducts seminars overseas on request. Such seminars may be held for either an individual nation or for countries of a region. The Division of International Training facilitates the organization and development of these seminars.

A variety of sources provide funding support for the seminars such as the Agency for International Development of the State Department, the International Labor Organization and other international groups, and the participants' own countries. Record copies of financial accounting records are maintained in the Bureau's central Division of Financial Planning and Management of the Office of Administration, although some supporting records are maintained by the DIT for the latter's internal management and control.

In addition, each year, some 300-400 persons from other countries come to BLS for specific information or discussions with various experts in the Bureau. These visitors may come for only a few hours or a few days, but some come for a week or two. The DIT arranges programs (schedules) and appointments for them. Also, such programs may be arranged for seminar participants.

Furthermore, the DIT may make arrangements for Bureau officials and employees to visit governments of other countries or to serve as consultants overseas.

RECORDS OF THE DIVISION OF INTERNATIONAL TRAINING

75. Division Chief Program Subject Files. Maintained under the direction of the Division Chief, these files contain correspondence and related documents pertaining to the program activities of the Division that are not filed elsewhere. Folder labels include such titles as Announcement Cables, Overseas Assignments, Commissioner's Controlled Correspondence, History of International Training, Personnel, Labor Attaches, Regions, Countries, and the like.

Division Program and Administrative Files for earlier years, prior to 1986, were combined. (See Item 4 of this Record Schedule.)

*ITEM 75: Retention Period. Break files every 5 years. ~~Transfer~~
~~to WNRC.~~ Bring active materials forward as
 TRANSFER INACTIVE FILES TO WNRC. required. Destroy ~~when 10~~
 years old.

76. Division Administrative Subject Files. Maintained by the Administrative Staff of the Division, these files pertain to such internal housekeeping matters as budgeting, personnel, progress and activity reports, scheduling of rooms for seminars and other meetings, requisitions for services and supplies, internal office procedures, and the like.

Retention Period. Destroy when 5 years old, except for progress and activity reports, which should be destroyed when 5 years old or no longer needed for current business, whichever is later.

77. Division Internal Fiscal Management Files. Maintained by the Administrative Staff, these files pertain to Division-level control of funds and expenditures related to the International Training Program. Included are such items as Division copies of requisitions for equipment, supplies, reproduction, and other services (e.g., interpreter services); records of receipts of payments (funds) received and transmitted to the Bureau's central Division of Financial Planning and Management, Office of Administration; and copies of machine printout reports of the status of funds related to the Division's activities.

Record files are maintained by the Division of Financial Planning and Management.

Retention Period. Destroy when 7 years old. *transfer to the WNRC when 4 years old.*

78. Inactive Division Program and Administrative Subject Files. These files contain documents dated from 1961 to 1985, but primarily from 1972 to 1985, relating to program and internal administrative activities of the Division. Only a few papers in the files are dated earlier than 1972.

Retention Period. Transfer to the WNRC when 5 years old. Destroy when 10 years old or when no longer needed for current business, whichever is later. An initial screening and destruction of obsolete material should be made upon approval of this Record Schedule.

*79. Division Time and Attendance Files. Consist of Division copies of time and attendance and related flexitime records pertaining to Division personnel. Official records are maintained in the central BLS Office of Administration. Such records appear to be covered by the Privacy Act.

Retention Period. Destroy when 3 years old.

*80. Name Personnel Files. Consist of copies of personnel name files of current and former employees of the Division, containing such documents as copies of requests for personnel action, notifications of personnel action, performance appraisals, position descriptions, incidental correspondence, and the like.

Retention Period. Destroy 1 year after transfer or separation of employee.

81. Division Correspondence Reading Files. Consist of extra copies of correspondence prepared in the Division, arranged by date. Include copies of communications for the signature of Division personnel as well as higher level officials of the Bureau.

Retention Period. Destroy when 5 years old or when no longer needed for current business, whichever is sooner.

82. Word Processing Media Files. Consist of word processing central memory, diskettes, or other storage media used to produce hard copy textual materials such as correspondence, seminar materials, mailing lists, in-house administrative materials, and the like.

Retention Period. Review at least quarterly and scratch or otherwise destroy when no longer needed for current business.

83. Cable Files. Consist of copies of cables to and from U.S. diplomatic posts in other countries pertaining to activities of the Division of International Training. The messages are usually transmitted via State Department communication facilities and copies are also filed in that Department.

The files are divided into such sections as:

- a. Cable Reading Files. A central file of cables sent and cables received, arranged by date. Includes duplicates of messages contained in other sections of the files.
- b. Subject Cable Files. Cables arranged by subject, other than Program and Seminar Announcements.
- c. Region and Country Cables. Copies of cables that do not concern specific seminars, filed by region and thereunder by country.
- d. Miscellaneous Cables. Cables that do not apply to a country or countries.

A separate file of Programs and Seminar Announcement Cables is maintained

by a designated Seminar Coordinator. See Item 87.

Retention Period. Destroy when 5 years old.

84. Casual Visitors and Special Programs Files. During a year, the Division may receive some 350-400 persons from other countries who come to BLS for specific information or discussion with various experts in the Bureau. These visitors may come for only a few hours or a few days, but some come for a week or two.

The Division arranges programs and appointments for such persons, including meetings with BLS personnel and experts in other government agencies in Washington and the field. In addition, some programs of this nature may be arranged for seminar participants.

The files contain such materials as a program (schedule) for the visitor, a visitor record card, visitor biographical data, incidental correspondence, and the like.

Retention Period. Destroy when 5 years old.

85. Record Copy of BLS International Training Newsletter Files. Since 1981, the Division of International Training has issued a newsletter, usually quarterly. Prepared within the Division, the newsletter is distributed, primarily to former participants in the Division seminars. Typically, the issues contain information about such matters as upcoming seminars; other activities and plans of the Division; status of the Division staff; word from former participants as to their status, location, accomplishments, etc; and the like.

Dating from the initial issue in March 1981, the files contribute to the history of the Bureau's International Training activities. Arranged by date in one 3-ring binder, the volume and annual accretion are negligible.

Retention Period. *BREAK FILE ANNUALLY.*

- a. Record Copy. Permanent. Transfer to the WNRC when 6 years old. Offer to the Archives of the United States in blocks of 20 years; the most recent record is 10 years old.
- b. Other Copies. Destroy when no longer needed for current business.

86. Record Copy of International Training Program Catalogs and Other Announcements. Periodically and as required, the International Labor Statistics Program Center (operated by the Division of International Training) issues announcements of its training programs/seminars.

Usually, these announcements include an annual catalog and seasonal schedules (e.g., spring) of seminars providing such information as the seminar title, its target audiences, dates, objectives, and course content, as well as other related data regarding admission procedures. Copies of these issuances are distributed to U.S. diplomatic posts and to governments of other countries throughout the world.

The practice of issuing catalogs was started in 1977. Before that time, announcements were issued by cable and correspondence.

Although not assembled as a collection, there are plans to establish such a collection, and copies are generally available. Copies date from 1978 forward. While some issues may be missing, this file represents the most complete available set of descriptions of the Bureau's International Training programs. Volume consists of less than 1 cubic foot, and annual accretion is negligible. Arranged by date.

Retention Period. *BREAK FILE ANNUALLY*

- a. Record Copy. Permanent. Transfer to the WNRC when 5 years old. Offer to the Archives of the United States in blocks of 15 years when the most recent record is 15 years old.
- b. Other Copies. Destroy when no longer needed for current business.

87. File of Program and Seminar Announcement Cables. Maintained by a designated Division Seminar Coordinator, this file includes copies of cables to selected State Department diplomatic posts, conveying announcements of the annual programs of international seminars, seasonal announcements, reminders of upcoming sessions, and the like.

Retention Period. Destroy when 5 years old.

88. International Seminar Case Files. For each seminar managed by the Division of International Training, a case file is constructed and deposited in the Division central files. Typically, for a seminar, the file will include such materials as the agenda; a list of participants, with their home addresses; participant biographical data; correspondence on such matters as confirmation of participant attendance, distribution of group photographs, appreciation to guest speakers, mailing of training materials to participants' home locations, etc.; travel authorizations for field trips; seminar completion ceremony arrangements; participants' evaluations of the seminars; and the like. Individual participant name folders are included.

Retention Period. Destroy when 15 years old. Transfer to the Washington National Records Center when 5 years old.

89. Seminar Coordinator Planning and Activity Notebook. For each assigned seminar, some seminar coordinators maintain a Planning and Activity Notebook, which serves as a seminar management tool.

Its contents may include such items as a copy of the agenda; a record of participant attendance; a list of lecturers/speakers and background information on such persons; confirmations of guest lecturers/speakers commitments; copies of correspondence regarding arrangements for field trips; checklist of seminar management tasks; copies of letters of appreciation; the coordinator's evaluation report to the Division Chief; and special programs (appointments) for some participants to meet with BLS experts or representatives of other organizations.

After completion of a particular seminar session, copies of significant items will also be placed in the International Seminar Case Files (Item 88).

Retention Period. Destroy when no longer needed for current business, provided that copies of appropriate items have been transferred to the International Seminar Case File (Item 88).

*90. Seminar Participant Data Base. At a BLS central computer facility, a data base pertaining to individual seminar participants is maintained on disk storage. Data entry and access are accomplished, normally, via terminal located on-site in the International Training Center.

A participant record includes such data elements at the individual's name, sex, and country; his/her employer or affiliation; year of seminar; seminar duration; identity of sponsor; if interpreter required (if so, language involved); whether participated in other Division seminar(s).

SAS software is used. Computer programs are maintained on disk storage and in hard copy printouts. Also available is a Participant Record Form that lists and defines the data elements.

For security and back-up purposes, disk-to-tape dump is performed twice weekly at the computer facility for possible disk regeneration if required.

Retention Period. Scratch individual participant record 10 years after individual's latest attendance at a BLS seminar.

91. Manual Files of Participant Address Lists. Consist of hard copy mailing address lists, by home country of former participants in International Training Center Seminars. Current mailing lists are also maintained in word processing files (Item 8 of this Record Schedule).

Retention Period. Destroy when no longer needed for current business.

92. Files of Photographs of Seminar Participants. Maintained in 3-ring binders, contents consist of still photographs pertaining to selected seminars, including group photographs of participants, guest speakers, and presentations of completion of seminar certificates by various BLS officials. File dates from 1975 forward. The older photographs are in black and white; those for later years are in color. Negatives are not available.

Retention Period. Transfer to the WNRC when 5 years old. Destroy when 15 years old or when no longer needed for current business, whichever is later.

93. Seminar Instruction Materials Files. Seminar coordinators are responsible for maintaining master sets of the instruction materials pertaining to their assigned seminars. Guest speakers/lecturers (experts) are used extensively, and the nature of instruction imparted and the types of related course materials vary. Consequently, while some uniformity exists as to structure and content, rigid standardization does not.

In general, the training materials for a seminar session may include such items as the agenda, lecture outlines (when obtained), lecture handouts, exercises, and participant reading materials. The materials may be categorized as: (1) Seminar Coordinator instruction guide items; and (2) Participant Workbook (reading materials).

Much of the handouts and reading materials consist of reprints of BLS documents such as press releases, published statistical bulletins, Monthly Labor Review articles, mathematical-statistical studies, and procedural instructions, and copies of materials issued by other government agencies or private economics information sources. While some audio visual aids are used, such as overhead projection transparencies, only a small quantity are in the files and are short-lived because of the constantly changing content. Such films as are used consist of borrowed copies. For a period (about 1978-84) video cassettes were made of selected presentations, such cassettes being used for background orientation of the Division Staff and other BLS guest lecturers (see Item 94).

The Video cassettes are no longer made.

Guest speakers seldom contribute their lecture outlines, lecture notes, or audio visual aids to the Division's files.

A particular seminar is ordinarily presented once per year, and the instruction materials are usually revised annually, as required. Replaced materials are destroyed when they no longer have reference value for training purposes.

The master files of instruction materials are not centralized, but they are maintained by the assigned coordinators at various locations in the Division.

Extra copies of some items such as handouts and reading materials are maintained for distribution.

Retention Period.

- a. Master Files of Instruction Materials. Destroy replaced materials when no longer of value for training purposes. For discontinued seminars, destroy latest master set 10 years after discontinuance or when no longer needed for current business, whichever is later.
- b. Other Copies. Destroy when obsolete or when no longer needed for current business, as appropriate.

94. Reference File of Selected Video Cassettes of Seminar Lectures. For a period (about 1978 to 1984), video cassette records were made of selected seminar presentations. These records are used primarily for background review by the International Training Center staff. The cassettes are not distributed outside the Division, although they are available to other BLS guest speakers for review in preparing a lecture.

This very limited file cannot be considered a documentation of training activity.

Retention Period. Scratch or otherwise destroy when no longer needed for current business.

95. Closed Country Files. Arranged by country, these files consist of copies of cables, letters, etc., with related documents concerning participation of persons from other countries in BLS international seminars. In some instances, materials relate to special programs of activity for visitors from such countries. Contents date from 1970 to 1985.

Retention Period. Destroy when 5 years old.

96. Region Files. Copies of correspondence and related materials applying to specific regions or countries and concerning international training matters but not a specific seminar(s). When warranted by the volume of documents pertaining to an individual country, a country folder may be established and filed under the region.

Retention Period. Destroy when 5 years old.

97. Inactive Norman Root Files. A closed file consisting of materials accumulated by former BLS employee Mr. Norman Root related to visits to various countries, including Egypt and Liberia, to discuss their labor statistics activities. Included are such materials as correspondence, working papers, and copies of reports. For the most part, the papers bear 1985 dates. They comprise 1 cubic foot.

Retention Period. Transfer to the WNRC. Destroy in 1992, ~~unless otherwise indicated by a separate business~~
~~withhold order.~~

98. Hotel Accommodations Reference File. A small reference file of directories, brochures, pamphlets, correspondence, and the like, containing information about lodging, transportation services, etc., in selected localities.

Retention Period. Destroy when obsolete or no longer needed for current business, as appropriate.

99. Technical Reference Background-Working Files. In carrying out their duties related to such activities as developing and updating seminar arrangements and instruction materials, planning and managing seminars, and conducting training, seminar coordinators, economists, and other Division personnel at all levels accumulate background reference files. Typically, such files relate to the individual's assigned areas of responsibility or to other BLS statistical programs, or to training technology in general.

These files may include such items as extra copies of BLS news releases, BLS published reports of statistical data, BLS internal procedures manuals, copies of articles on economics published by BLS or other sources, professional texts, periodicals, extra copies of correspondence, issuances of other government or private sources, longhand notes, working papers, and the like.

This file item does not cover other files that are listed as specific items in this Record Schedule.

Retention Period. Review at least annually to identify disposable materials. Destroy when superseded, obsolete, or no longer needed for current business, as appropriate.

OFFICE OF SURVEY PROCESSING
OFFICE OF THE ASSISTANT COMMISSIONER

100. OSP Assistant Commissioner Program-Administrative Subject Files. At the time of this writing, there are two segments to the Program-Administrative subject file of the Assistant Commissioner for the Office of Survey Processing, the computer support office for the OEUS, Price, OWIR, OSH, and formerly the OPT statistical program of the Bureau. These are the active and inactive files of the Assistant Commissioner for OSP.

The active files, at present, from 1985 to date are presently maintained by the Assistant Commissioner for the Office of Technology and Operations, Carl J. Lowe, who serves also as Acting Assistant Commissioner for the Office of Survey Processing. Mr. Lowe maintains the files for the OSP assignment intermixed within his Administrative Program Subject File for OTOR, which is described in the Schedule at the first item under the OTOR subdivision. It is expected that an appointment of an Assistant Commissioner For Office of Survey Processing may be made in the near future, at which time a separate administrative-program subject file is expected to be established.

The inactive closed file of former Assistant Commissioner for OSP, William Eisenberg covers the period 1981-1985. This general correspondence and related records file consists primarily of incoming internal BLS memoranda from various staff or program offices; copies of outgoing communications prepared by Mr. Eisenberg or his Project Managers who head the various Divisions comprising OSP; copies of various reports on computer operations mainly in printout format covering computer costs and detailed computer operations; Regional Office correspondence; records of staff meetings and of various BLS Committees or task forces primarily involving computer support operations.

The file is in three major segments; (1) a chronological segment covering the detailed computer processing operations for the Employment-Unemployment, the Price, the Wage-Industrial Relations, and Safety and Health, and formerly the Productivity Statistics programs of BLS; (2) a general background file on computer costs and operations within BLS; and (3) an alphabetic subject file on computer processing operations covering such topics as Budget, Staff Meetings, Procurement Management, Flexitime, Contracts, Privacy-Security of BLS Data, Progress Reports, Training, MIS Systems, and the like.

OSP is primarily an operating support office. Activities concerning Bureau policies on computer systems design and computer operations are presently more completely documented in the records of the Deputy Commissioner For the Office of Administration and Internal Operations and in the files of the Assistant Commissioner for Office of Technology and Operations Review.

BREAK FILE ANNUALLY.
Retention Period. A Transfer to the WNRC when 5 years old. Destroy when 10 years old, or when no longer needed for current business, whichever is sooner.

101. OSP Assistant Commissioner Technical Reference - Working File. These are extra copies of printed materials, bulletins, articles, reference copies of instructional manuals and memoranda, and the like maintained by the former Assistant Commissioner for OSP, and which would be retained in the

future when a separate Assistant Commissioner for OSP may be appointed. Such files cover various computer operations matters, statistical procedures and methodology, as well as background on various BLS programs for which computer support operations are furnished.

Retention Period. Destroy when superseded, no longer needed for current business, or when made obsolete, as appropriate.

102. OSP Administrative Officer Files: The former Administrative Officer in the Office of the Assistant Commissioner of OSP maintained an Administrative subject file consisting primarily of name files covering all OSP personnel. While some subject folders on various administrative matters remain, the bulk of the file consists of extra copies of personnel forms filed alphabetically by name. It is expected when a separate Assistant Commissioner for OSP is appointed, that a similar Administrative Officer file will be established.

As with all administrative files within the program or support offices of BLS, this file is not a record copy file. The record copies of files on administrative matters are maintained by the appropriate Divisions of the BLS Office of Administration.

Personnel name files are covered by the Privacy Act.

Retention Period.

- a. Personnel Name Files. Destroy one year after separation or transfer of employee.
- b. Time and Attendance Records. Destroy after GAO audit or when 3 years old, whichever is sooner (GRS 2, Item 2b.).
- c. All other records. Transfer to the WNRC when 3 years old. Destroy when 5 years old.

OFFICE OF ADMINISTRATION
BUREAU OF LABOR STATISTICS

The Assistant Commissioner, Office of Administration, acts for the Commissioner in planning and directing a broad program of administrative management in support of the Bureau's economic and statistical survey, research, and analysis programs. The Assistant Commissioner provides leadership and policy direction to Bureau programs and operations relating to budgeting and fiscal management, personnel organization and management, management analysis, management systems, procurement, facilities management, office services and supply, emergency preparedness planning, equal employment opportunity, and the like.

The Office of Administration includes the immediate office of the Assistant Commissioner, the Division of Management Systems, the Division of Personnel Organization and Management, the Division of Financial Planning and Management, and the Division of Administrative Services.

OFFICE OF THE ASSISTANT COMMISSIONER

103. Assistant Commissioner's Administrative Management Program Files. These document files, maintained by the Secretary to the Assistant Commissioner for Administration, reflect the interests of that official in the direction of the Administrative Management programs and systems of the Bureau. Examples of topics covered include: Administrative (concerning such sub-topics as Combined Federal Campaign; comments on Draft Bills, Regulations, and Legislation; FOIA; GAO Review; etc.), Awards, Budget, Management (with such sub-topics as Internal Control; Move/Relocation; Printing, Publication, and Audiovisual; and Space), Organization, Labor Management Relations Policy, Personnel, Planning, Procurement, Reports, System Studies, Training, and Travel. Arranged by subject, these files have been broken annually since 1979 although earlier files are consolidated by subject.

In addition, a separate section of the files is maintained, arranged by subject, containing materials considered to have a more historical reference use concerning administrative actions and policies of the Bureau. This historical reference section, dating from 1961 to 1979, concerns such subjects as BLS Organization and Functions, Affirmative Action Plan for Handicapped and Disabled Veterans, BLS Personnel Management Services, BLS Upward Mobility, Labor Management Relations, Policy Correspondence-1977, Policy on Release of Microdata, and Projects (folders on such matters as BLS Efficiency System). This files section comprises about 6 cubic feet, and annual accretion is negligible.

Retention Period.

- a. Active Files. Break files annually and bring active material forward to the current year as required. Destroy when 5 years old, or when no longer needed for current business, as appropriate. Review files at least once a year and destroy unneeded reference materials, duplicate copies, transmittals, and other non-record items.
- b. Historical Files. PERMANENT. ~~Transfer~~ to WNRC when no longer needed for reference. ~~Transfer~~ to the National Archives when most recent record is 20 years old.

104. Reading Files. Consists of extra copies of communications prepared in the immediate Office of the Assistant Commissioner, arranged by date, for the signature of officials of that Office or higher level officials such as the Commissioner, BLS.

Retention Period. Destroy when 5 years old.

*105. Time and Attendance Files. Consist of office copies of time and attendance, leave and earnings, and related flexitime records pertaining to personnel of the Office of the Assistant Commissioner. Official records are maintained at the Division of Financial Planning and Management. Such records are covered by the Privacy Act.

Retention Period. Destroy when 3 years old.

106. File of Photographs from Awards and Other Ceremonial Occasions. This closed file consists, primarily, of copies of photographs taken at Bureau employee awards ceremonies, although also included are a few taken at retirement occasions, and a few incidental photographs of former BLS personnel--some of whom are unidentified.

Retention Period. Destroy when 1 year old or when no longer needed for current business, whichever is later (GRS 2111)

*107. Employee Awards Committee Files. Maintained by the Executive Secretary of the BLS Awards Committee, these files include such materials as case files (including recommendations, approved nominations, etc.), memoranda, correspondence, and reports pertaining to BLS-sponsored cash and noncash awards such as quality-step increases, superior performances, suggestions, and letters of commendation. Included also may be correspondence and announcements regarding awards by other Government agencies and private organizations.

Retention Period. Destroy when 2 years old or when no longer needed for current business, whichever is later.

108. Word Processing Media Files. Word processing storage media, such as diskettes or other electronic memory used in preparing hard copy textual or tabular materials such as correspondence, reports, or items for presentations.

Retention Period. Scratch when no longer needed for current business.

109. Equal Employment Opportunity Subject Files. Maintained by the BLS EEO Coordinator, these files contain such items as correspondence, reports, and employment statistics (machine listings) related to ethnic group and sex, affirmative action plans, reference materials, and the like, pertaining to EEO/Affirmative Action activities in BLS.

Retention Period. Break files annually and bring active material forward to the current year as required. Transfer to the WNRC when the most recent record is 3 years old. Destroy when 5 years old, or when no longer needed for current business, whichever is later. Files should be reviewed at least annually to dispose of non-record items such as reference materials.

*110. EEO Case Files. Maintained by the BLS EEO Coordinator, these files contain duplicate records of such documents as EEO complaints, investigative reports, administrative processing actions, and higher level decisions as applicable. Record copies are maintained at the Department of Labor Office of Civil Rights.

Retention Period. Destroy 4 years after resolution of case.

DIVISION OF PERSONNEL AND ORGANIZATION MANAGEMENT
BUREAU OF LABOR STATISTICS

- a. Mission. To plan, develop, initiate, and direct a comprehensive program of personnel, organization management, and employee development for the Bureau.
- b. Functions.
- (1) Administers a program which provides recruitment, placement, merit staffing, position classification/management, employee relations, organization planning, development, and analysis services.
 - (2) Provides consultative services to Bureau managers in each of these program areas in support of their personnel management and work-force planning activities.
 - (3) Interprets and implements policies and procedures developed by the Office of Personnel Management, the Merit Systems Protection Board, the Department, and other sources. Develops policies and procedures in support of programs initiated by or peculiar to Bureau operations.
 - (4) Conducts broad management engineering and other studies independently, or in conjunction with other areas of the Office of Administrative Management which include workload determination, staff utilization and projected staffing requirements, and encompass the full range of management responsibilities in major organizational or functional areas in the National and Regional offices.
 - (5) Conducts comprehensive and special organizational and occupational, position management or related studies, identifying problems, recommending solutions and assisting, where appropriate, in the implementation of approved recommendations.
 - (6) Prepares and maintains personnel records and reports.
 - (7) Provides staff assistance and advisory services to the Regional Offices on personnel management matters which have national impact and scope on all organizational planning analysis and developmental activities, and on their relationships with Regional Administrative Offices.
 - (8) Coordinates, directs, and provides guidance and assistance to managers, supervisors, employees, and employee organizations with regard to labor-management activities.

- (9) Plans and develops programs and conducts studies which ensure a flexible and appropriate classification and staffing structure for the Bureau.
- (10) Provides an integrated organization planning system, including the analysis of proposed organizational changes for soundness and adequacy of documentation and assists in the planning and/or development of proposed reorganizations; maintains the Bureau organization manual.
- (11) Provides the initiative and serves as the focal point for the coordination and implementation of organizational development and improvement activities.
- (12) Maintains liaison with the Office of the Assistant Secretary for Administration and Management and the Office of Personnel Management on classification standards and related matters, recruitment, employee relations, and all other personnel and management programs and issues requiring Departmental approval.
- (13) Administers the Bureau's employee career development and education program.
- (14) Maintains liaison with the Office of the Assistant Secretary for Administration and Management on training policy procedures and related matters particularly regarding programs of a Department-wide nature.
- (15) Develops and administers Upward Mobility program for nonprofessional employees.
- (16) Reviews and approves nominations for training outside the Department of Labor.
- (17) Provides orientation programs for new employees.
- (18) Develops, arranges and conducts lectures and seminars on technical and administrative subjects.
- (19) Maintains training records for all employees; prepares annual training report and special reports as required by OPM or the Department.
- (20) Administers the Bureau's College Recruitment Program and other special Employment Programs such as Cooperative Education, Student Volunteer, Junior Fellowship, Handicapped, Summer Employment, Stay-in-School, Part-time Employment and Special Emphasis Programs such as Black History and Hispanic Heritage.

DIVISION OF PERSONNEL AND ORGANIZATION MANAGEMENT

The Personnel and Organization Management Division staff includes personnel management specialist, employee development specialists, and support personnel. They provide the Bureau of Labor Statistics with support in all aspects of Personnel Management such as: career development, planning, employee relations, staffing, counseling, and other personnel and training functions and activities. Each specialist is responsible for providing a wide range of personnel and employee development services, which include recruitment, placement, merit staffing, position classification, employee relations, organization planning, development, and analysis services.

111. Division Chief, Program and Administrative Subject File. These document files, maintained by the Secretary to the Personnel Officer contain incoming and outgoing correspondence pertaining to housekeeping and program affairs such as budgets, procurement, travel, regulations, equipment/supplies, and labor relations correspondence. Also included are weekly and monthly progress reports and monthly training reports and program documentation, such as Upward Mobility Program and Cooperative Education Program.

Retention Period. Transfer to the WNRC when [redacted] 3 years old. Destroy when 5 years old [redacted]. Files should be reviewed at least annually to dispose of non-record items such as reference material.

BREAK FILE ANNUALLY.

*112. Technical Reference - Working File. Consists of extra copies, printed materials, working papers, copies of manuals and memoranda, and the like, which are maintained for Division personnel use.

Retention Period. Destroy when superseded, no longer needed for current business, or when made obsolete, as appropriate.

*113. Division "Chrono" Files (Chronological). The Chrono/Concurrence Sheet File. These files consists of carbon copies of all outgoing correspondence, normally arranged in chronological order (month/year). However, a separate (cross reference) file is kept in alphabetical order. Maintained by the Secretary to the Personnel Officer.

Retention Period. Transfer to the WNRC when the most recent record is 3 years old. Destroy when 5 years old. [redacted]

*114. Name Personnel File. Consists of Time and Attendance Records, Performance Standards and Appraisals, Performance Ratings, incoming and outgoing correspondence, and the like, pertaining to the employees of the Division.

Retention Period. Destroy 3 years after transfer or separation of the subject employee.

*115. Official Personnel Folders. This is the official record of the civilian service in the Federal Government of the paid employee. Papers authorized for disposal elsewhere are not included. Folders of separated employees are transferred to an inactive file on separation in accordance with the Federal Personnel Manual.

- a. Transferred employees. See Federal Personnel Manual for instructions relating to folders of employees transferred to another agency (GRS 1, Item 1(a)).
- b. Separated employees. Transfer folder to National Personnel Records Center (NPRC) St. Louis, Mo, 30 days after separation. NPRC will destroy 65 years after separation from Federal Service (GRS 1, Item 1(b)).
- c. Temporary Employees. Destroy upon separation or transfer of employee or when 1 year old, whichever is sooner (GRS 1, Item 10).

*116. Name Folders of Performance Evaluation Appraisals. This file consists of acceptable and unacceptable performance appraisals of BLS personnel, filed alphabetically by name.

Retention Period. Apply the retention period of GRS-1, Item #23, as applicable.

*117. Journal Copy of SF #50 Personnel Actions. These are copies of notification of personnel action arranged chronologically and used for verification purposes.

Retention Period. Destroy when 2 years old, reference GRS-1, Item #14.

*118. Position Description Files. These are copies of position descriptions showing for a position its organizational location, grade, responsibilities, and duties involved, and related information.

Retention Period. Review regularly, transfer Position Description records that are abolished or superseded from the position number file to the Position Description Historical Reference File. Destroy 5 years after position is abolished or superseded. *DEVIATES FROM GRS 1/76*

*119. Personnel Operations Statistical Reports. File consists of statistical reports relating to Bureau of Labor Statistics personnel and maintained by a representative Personnel Management Specialist for each division/office.

Retention Period. Destroy when 3 years old, GRS #16.

*120. Merit Staffing Selection Files. Records relating to the promotion of an individual that documents qualification standards, evaluation methods, selection procedures, and evaluations of candidates.

Retention Period. Transfer to the WNRC 3 years after the personnel action. Destroy when 6 years old.

*121. Certificate of Eligibles Files. Copies obtained from OPM of certificate of eligibles with related requests, forms, correspondence, and statement for selection.

Retention Period. Destroy when 2 years old (GRS 1/5)

122. Offers of Employment Files. Correspondence, letters, and telegrams offering appointments to potential employees.

Retention Period.

- a. Accepted Offers. Destroy immediately. A copy of the mailgram is retained with the SF-39 in the certification book (GRS1, ITEM 4a)
- b. Declined Offers. Destroy when 2 years old.

When name is received from certificate of eligibles, return to OPM with reply and application. A copy of the mailgram is retained with the SF-39 in the certification book. Destroy when 2 years old. GRS 1, Item 4b

*123. Employment Applications. Applications (Standard Form 171) and related records, excluding records relating to appointments requiring Senatorial confirmation.

Retention Period. Destroy 3 years old, provided the requirements of the Federal Personnel Manual, Chapter 333, Section A-4, are observed. Destroy OPF copy of the SF-171 when no longer needed for reference. *DEVIATE FROM GRS 1/15*

*124. Personal Injury Files. Forms, reports, correspondence, and related medical and investigatory records relating to on-the-job injuries, whether or not a claim for compensation has been made.

Retention Period. Cut off on termination of compensation or when deadline for filing a claim has passed. Destroy 3 years after cutoff.

*125. Correspondence and Forms Files. Operating personnel office records relating to individual employees not maintained in Official Personnel Folders and not provided for elsewhere in this schedule such as Handicap Code, National Origin, Verification of Employment, and log/transmittals of OPFs to Federal Records Center.

- a. Correspondence and forms relating to pending personnel actions *DEVIATES FROM GRS 1/17*
- Retention Period. Destroy when action is completed.

- b. Retention Registers - from which reduction-in-force actions have been taken.

Retention Period. Destroy when 2 years old.

- c. All other correspondence and forms.

Retention Period. Destroy when 1 year old.

*126. Student Volunteer Program Files. Copies of papers pertaining to each student volunteer under this program, to give students on-the-job

experience. File contains SF 171s, service agreements, requests for personnel action SF52.

Retention Period. Destroy 3 years after individual has separated or completed subject program.

*127. Employee Training Records - Computer Printout. A cumulative printout such as Training Information System, tracking completion of supervisory training.

Retention Period. Destroy previous printouts when superseded by updated reports.

*128. Individual "Employee Training" Case Files. Files consist of correspondence, memoranda, reports, and other records relating to the availability of training and employee participation in training programs.

Retention Period. Destroy when 5 years old or when superseded or obsolete, whichever is sooner. (GRS 1/29)

*129. Training Counselling and Development Files. Files consist of copies of Individual Development Plans (IDPs), Training Authorization and Evaluation Forms, Professional Training Files, Supervisory Development and ACT (Administrative, Clerical, and Technical) Training files. Also included are Common Needs Training applicant file, and student volunteer and Cooperative Student Program material.

Retention Period. Destroy 3 years after termination of counseling.

*130. Supervisory File. The file consists of training checklists, correspondence related to supervisory training, and status for each supervisor.

Retention Period. Transfer to the WNRC when 3 years old. Destroy when 5 years old or when superseded or obsolete, whichever is sooner.

*131. College Recruitment Files. Documents pertaining to college recruitment efforts, filed alphabetically by school name.

Retention Period. Destroy after completion of applicable program period.

*132. Recruitment File. File consists of correspondence, reports, and objectives related to the following programs: Federal Women, Black History, Handicapped. Also covers correspondence relating to Executive Leadership and other programs attended.

Retention Period. Transfer to the WNRC when 3 years old. Destroy when 5 years old or when superseded or obsolete, whichever is sooner.

*133. Cooperative Program Files. These are documents such as applications and related papers pertaining to the hiring of students through the Cooperative Program.

Retention Period. Destroy 3 years after completion of applicable program period.

*134. Employee Development Subject File. Documentation pertaining to making training opportunities available to employees of the Bureau of Labor Statistics, including records concerning arrangements for employee training and contacts and agreements for conducting employee training.

Retention Period. Break file every 3 years. Transfer to the WNRC. Destroy when most recent record is 7 years old.

*135. Cooperative Agreements. File consists of cooperative agreements established with individual colleges participating in Cooperative program.

Retention Period. Destroy 1 year after completion of applicable program period.

*136. Job Fair - Open House - File. This file contains the history file and working files for the October 12, 1983, CPIR Open House sponsored by the Bureau of Labor Statistics.

Retention Period. Break file every 3 years. Transfer to the WNRC. Destroy when most recent record is 5 years old.

*137. Upward Mobility Program. Files consist of correspondence, reports, regulations, rules, applications, analysis, and related staffing strategies for the Bureau's Upward Mobility Program.

Retention Period. Destroy when superseded, obsolete, or no longer needed for reference.

138. Training Aids. Files consist of background material, notes, lesson plans, testing materials, syllabus, manuals, and other material developed by the personnel training staff.

RE [REDACTED]

Retention Period. Destroy when superseded, obsolete, or no longer needed for reference.

139. Course Development - Instructor Guides - Training Aids. Files consist of correspondence, memoranda, reports, plans, and objectives relating to the establishment and operation of training courses such as correspondence, flexitime, RIF, RAS (Resource Availability System), computer training, budget, and merit pay, conference training, orientation program and career counseling working files.

Retention Period. Destroy when 5 years old or 5 years after completion of a specific training program (GRS 1/29)

140. Course Announcement Files. Reference files of pamphlets, notices, catalogs, and other records which provide information on courses or programs offered by non-government organizations.

Retention Period. Destroy when superseded or obsolete.

*141. Personnel Employee Records - PER - Adverse Action File. Case files and related records created in reviewing an adverse action such as restrictions, leave without pay, reprimands, and the like.

Retention Period. Destroy 4 years after case is closed (GRS 1/30b)

*142. Grievance Files. File consists of records pertaining to the review of grievance and appeals raised by agency employees except EEO complaints, i.e., Federal Labor Relations Board.

Retention Period. Destroy 3 years after case is closed. (GRS 1/30a)

ALL OFFICES

Listed below are files that were found in many of the offices that constitute the Division of Personnel Organization and Management. To avoid repetition, these items are listed here, and the retention periods supplied have been included to ensure adequate disposition coverage of the records concerned.

143. Office Copies of Department Directives. These are reference copies of Department directives that are maintained in operating offices for policy and procedural guidance.

Retention Period. Destroy when superseded, obsolete, or no longer needed for current business.

144. "Chrono," "Reading," "Tickler," or "Suspense" Files. These files consist of a copy of all outgoing correspondence arranged in chronological order. They are used as a convenient reference or to flag a due date or some other action.

Retention Period. Destroy when 1 year old.

145. Press Releases, Statements, Speeches, and Testimonies. These are copies of the items specified in the title, and are used as precedents and/or other reference purposes.

Retention Period. Destroy when superseded or when 2 years old, whichever is sooner.

146. Personnel Management Information System (PERMIS) Data Base. DPOM (Division of Personnel and Organization Management) maintains a computerized system for tracking personnel data, employment history, training data, and the like for each employment within BLS (Bureau of Labor Statistics). Such data are also available in hard copy form in other DPOM files.

The data base was developed by the U.S. Air Force and is maintained, on disk, at the GSA's Computer Facility at Kansas City, Missouri. The system is an on-line system and is accessed via satellite. DPOM support staff enter data daily via remote terminals. Disk-to-tape backup procedures are performed daily at the GSA's Computer Facility.

System documentation includes programs and related system specifications maintained by the GSA'S Computer Facility at Kansas City. User guides are on hand in the Bureau's DPOM.

Scheduled and on-demand management reports are available, such as: RIP (Report on Individual Persons), Position Established Notice, Initial Supervisory Training, Interim Probation Report, Position Change Notice, and Employee data.

Retention Period.

- a. Data Records. Scratch when no longer needed for current business.
- b. System Documentation Maintained by OPOM. Destroy when obsolete, superseded, or no longer needed for current business.

147. Computer Printouts Used for Referencing Monitoring, and Performing Personnel Management Activities. These files consist primarily of machine printouts, covering a variety of subject areas, such as performance evaluations, standing registers, EEO listings, and the like. These printouts are utilized by the personnel staff (e.g., Personnel Management Specialists and Employee Development Specialists) to carry out the day-to-day operations of the personnel office. This item does not apply to specific items or programs of a similar nature covered elsewhere in this schedule.

Retention Period. Destroy when all essential information has been analyzed, tabulated, or issued, or when obsolete/revised, as appropriate.

148. Emergency Preparedness Classified Files. Consist of classified records accumulating from emergency preparedness planning for the Bureau, such as continuity of operations and providing statistical data to Government officials and others as appropriate. Copies of relative documents are also furnished to Departmental headquarters, Office of Emergency Preparedness Planning.

Retention Period. Destroy when 3 years old or no longer needed for current business, whichever is later.

**DIVISION OF FINANCIAL PLANNING AND MANAGEMENT
OVERVIEW OF DIVISION MISSION, FUNCTIONS, AND ORGANIZATION**

The Division's mission is to support the mandate of the Bureau of Labor Statistics by carrying out all Bureau financial operations in accordance with applicable law, regulation, and guidance.

The Division has seven major functions:

- ° Formulation of the Bureau's annual budget request for reimbursable, salary and expense funds and preparation of the budget defense for the Commissioner
- ° Review of operating budgets for all Bureau activities and liaison with Bureau staff responsible for implementing budgets
- ° Execution of the Bureau's total budget availability and assurance that all obligations are approved, appropriate, and within legal limits
- ° Maintenance and Preparation of the Bureau's monthly report on the number of civilian employees and the actual and projected full-time equivalency as it relates to the civilian employment.
- ° Preparation of periodic reports that currently project the status of all Bureau funds to date and to the end of the year for administrative oversight purposes
- ° Performance of all accounting functions and processes on behalf of the Bureau, including:
 - Accounts Payable
 - Accounts Receivable
 - Payroll
- ° Administration of the Bureau's Labor Market Information (LMI) Cooperative Statistical programs with States and the Occupational Safety and Health Statistics (OSHS) grants with States.

The planning and management of the Bureau's financial operations are both crucial and complex. In order to carry out its functions, the Division is divided into four separate but interrelated units: Budget, Reimbursables, Accounting, and Grants Management.

The Budget staff is responsible for the formulation and execution of the Bureau's budget for salaries and expenses and for the analysis and reporting on its status.

- ° The Reimbursable staff is responsible for the formulation and execution of the Bureau's budget for reimbursable activities and for the analysis and reporting on its status. This staff also maintains the records and prepares the various monthly employment reports.

- ° The Accounting staff is responsible for the maintenance of all records and systems reflecting the Bureau's obligations and receipts and for the reporting of its transactions.
- ° The Grants Management staff is responsible for the financial and administrative management of the Bureau's Cooperative Agreements with States.

Functioning as the financial office for the Commissioner and for the Bureau, the Division is responsible for extensive reporting and advising on financial plans and operations. These reports provide the financial information that the Bureau needs to meet its legal requirements of obligating funds for the purposes and within the limits set by Congress, the Office of Management and Budget, and the Department of Labor.

149. Technical Reference Material - Branch Wide. File consists of technical reference materials, SOP (Standard Operating Procedures) for safety, mail, security, convenience copies of documents and other working papers maintained for convenience of office operations by various members of the branch.

Retention Period. Destroy when superseded or no longer needed for current business, whichever is sooner.

*150. Technical Reference - Working File. File consists of copies of printed material, working papers, copies of outdated Budget Reports (1944-1986), correspondence/memoranda, and the like, which are maintained for Division personnel use.

Retention Period. Destroy when superseded or no longer needed for current business or when made obsolete.

*151. Budget Position Control Book. The file consists of looseleaf bound computer printouts that reflect all BLS positions, sorted by Home Code, type, position number, title, name, authorization, and field station.

Retention Period. Transfer to the ~~W~~ when 3 years old. Destroy when 5 years old.

*152. Interagency Agreements. File consists of interagency agreements with other government agencies for support and services, e.g., NIH Computer Facility, for computer support. Contents of the files include Agreement, Status Reports, Reimbursable Agreement (BC-505A), Contract Obligation Form (DPPM-101), Official Cost Estimates and Acceptance, Monthly Expense Statements, Correspondence/Memoranda, Incoming and Outgoing.

Retention Period. *TRANSFER TO THE WNRC 3 years after period covered*
 Destroy 6 years and 3 months after period covered by Agreement. Ref. GRS-3, Item 3.

*153. Employment Reports. Files consist of statistical information relating to BLS on-board strength, and are filed by month and year. Contents consist of a Monthly Report of Federal Civilian Employment--SF113-A.

Retention Period. Transfer to the ~~W~~ when 3 years old. Destroy when 5 years old.

*154. State Contracts. File consists of Contracts with individual States, to perform BLS related activities. Files contain Authorization for Payment on Contract, Contract, Amendments, Financial Report and Correspondence/Memoranda, Incoming and Outgoing.

Retention Period.

- a. Transactions of more than \$25,000. Transfer to the WNRC 3 years after final payment. Destroy 6 years and 3 months after final payment (GRS 3, Item 3).
- b. Transactions of \$25,000 or less. Destroy 3 years after final payment (GRS 3, Item 3).

*155. Reimbursable Contracts, FY 84/85 and FY 86/87. The file consists of reimbursable contracts with non-governmental organizations and contain: Reimbursement or Advance of Funds Agreement, Form OPM-110, Award/Contract, Reports, Correspondence, Incoming and Outgoing, Obligating Actions, personnel actions, and administrative material.

Retention Period.

- a. Transactions of more than \$25,000. Transfer to the WNRC 3 years after final payment. Destroy 6 years and 3 months after final payment (GRS 3, Item 3).
- b. Transactions of \$25,000 or less. Destroy 3 years after final payment (GRS 3, Item 3).

*156. Division Chief's Program and Administrative Subject Files -- Reimbursables. Files consist of administrative and subject files pertaining to the budgets, operating budgets committees, apportionment, reconciliation, training, automatic data processing, and the like.

Retention Period. Transfer to the WNRC when 3 years old. Destroy when 5 years old or when no longer needed for current business, whichever is later. Files should be reviewed annually to dispose of non-record items such as reference material.

Break file annually.

157. Grant Management Training Material. File consists of Grant Management Seminar Training Material such as handouts, course material, extra copies of training materials.

Retention Period. Destroy when superseded or obsolete.

158. OSHS--State Files. Files consist of grants to states to support the BLS in the areas of safety and health. The files contain the grant, surveys, reports, correspondence, and Federal Assistance Form SF-424.

Retention Period. Transfer to the WNRC 3 years after completion of the grant. Destroy 6 years and 3 months after completion of the grant.

159. Grants Management Subject Files. Files consist of administrative and subject files pertaining to Budget, Cooperative Agreements, correspondence, manuals, funding, property, coding, work plans, and the like.

Retention Period. Destroy when 5 years old or when no longer needed for current business, whichever is later. Files should be reviewed at least annually to dispose of non-record items such as reference material. *DEVIATES FROM GRS 3/14*

160. Administrative Memorandum. File consists of memoranda directed to a region and/or states "for regional offices only" or "for states and regional offices" dealing with administrative matters, and are filed by type, FY, and sequence number.

Retention Period. Destroy when 2 years old or when no longer needed for current business. *(GRS 3/14)*.

161. Chronological File. These files consist of a copy of all outgoing correspondence arranged in chronological order. They are used as a convenient reference or to flag a due date.

Retention Period. Destroy when 1 year old.

162. Cooperative Agreement. File consists of Cooperative Agreement actions between individual states and DOL/BLS, in labor related matters. File contents include Federal Assistance Form, Status Reports, Agreement Actions, Notification of Obligatory Actions, Correspondence, Incoming and Outgoing, and the like.

TRANSFER 3 years after period covered.
Retention Period. Destroy 6 years and 3 months after period covered by agreement.

*163. Formulation Files. Files consist of BLS Budget Actions for FY 1978 through the present. Contents of the files include: Congressional Budget and Submissions, Congressional Hearings, Questions from the House and Senate, OMB Submissions, Budget Instructions, Press Briefings, Correspondence/Memoranda, Incoming and Outgoing, Briefing Books, and the like.

:Retention Period.

- a. Budget Policy Files. Permanent. Transfer to the WNRC when 5 years old. Transfer to the National Archives in 5 year blocks when the most recent record is 20 years old.
- b. All other records. Apply GRS 5 as appropriate.

~~Report - Destroy when 5 years old~~
~~All other - Destroy 3 years after end of fiscal year~~
~~f. Budget Appropriation Files - Destroy 2 years after close of fiscal year~~
~~Report GRS-5.~~

164. BLS Travel File. File consists individuals transportation requests, travel authorizations (DL-133), Travel Vouchers (SF-1012), Schedule of Expenses, and Memorandum. Also includes Voucher Schedule of Payment (SF-1166) File, which contains the passenger Ticket Copy (Airline). *DEVIATE FROM GRS 9/4a*

Retention Period. Destroy when 3 years old.

165. Administrative Subject Files - Accounting Unit. Files consist of administrative and subject files pertaining to: reports, personnel, meetings, procedure, payroll, and the like.

Retention Period. ~~Transfer to the WRC when 3 years old. Destroy when 5 years old.~~ *Braille file annually*

166. Report of Pay and Deductions. Computerized report of all pay and deduction transactions for a particular pay period by year.

Retention Period. Destroy when related pay records are audited by GAO or when 3 years old, whichever is sooner. *(GRS 2/14)*

167. Financial Accounting Reports. These computer generated reports contain a record of the total contract payments to date by accounts payable, accrued liability, and open obligations. The reports are Summary Fund Report Program Costs and Obligations by Cost Center, Detailed Fund Report, Total BLS & National Office Unliquidated Obligations, Financial Management Report, Project Reporting System, and Detailed Fund for BLS, MSHA, and OSHA.

*Also included are Personnel/Payroll Interface Report, Current Action Separation Report, Health Insurance Change Report, Retroactive Separation Report, Transaction Audit Report, and the like.

- a. Record Copy. Transfer monthly reports to the WNRC 2 years after the close of the fiscal year. Destroy 6 years 3 months after the close of the fiscal year involved (GRS 7, Item 3).
- b. Microfiche Copy. Destroy 3 years after the close of the fiscal year involved.

168. Routine Travel Procurement Files. Consist of Fare Card Memorandum and logs, and the Deposit Ticket/Refund File, which contains Travel Advance Repayments, Deposit Tickets, and Notice of Receipt of Check.

Retention Period. Destroy 6 years and 3 months after final payment.

169. Official Payroll Record. This is the official Payroll Record for

all current and inactive BLS civilian personnel. File contents: W4 Employee Withholding Allowance Certificate, Notification of Personnel Action (SF-50), Allotment Request (SF1198), Address Forms and memorandum, and similar type documents.

Retention Period.

- a. Allotment File. Destroy 3 years after superseded or 3 years after separation of employee. If employee transfers within an agency or between agencies, these authorizations must also be transferred (GRS 2, Item 4(a)(2)).
- b. Notification of Personnel Action File. Destroy when related pay records are audited by GAO or when 3 years old, whichever is sooner (GRS 2, Item 11).

170. Voucher Payment File. File consists of requests, authorizations, agreement, reimbursement documents (DL-1-101), Voucher for Transfers between Appropriations and/or funds (SF1080), Change Stats, Purchase Orders, Invoices, and memoranda.

Retention Period. Destroy 6 years and 3 months after period covered by account. (GRS 6/11a)

171. Journal Vouchers (SF1017). File shows debit and credit entries, contains request for approval of billing and memoranda, and the like.

- a. Record Copy. Destroy when 3 years old (GRS 7, Item 4(a)).
- b. All Other Copies. Destroy when 2 years old (GRS, Item 4(b)).

172. Contract Award File. File consists of successful contracts (bids and proposals) including Amendment of Solicitation/Modification of Contract (SF-30), miscellaneous obligations records, invoices, memoranda, and the like.

Retention Period. Destroy when related contract is completed (GRS 3/5a)

173. Passenger Transportation Files. Refer to Transportation Bills and Invoices and Government Transportation Request Files. Files include: Carrier Bills, Carrier Invoices, Public Voucher for Transportation Changes (SF-1113), and Government Transportation Requests (GTRs) (SFF1169), and the Travel Transaction Closed File for 1985 and 1986, filed by authorization number and containing the Travel Authorization (DL-1-33).

Retention Period.

- a. Issuing office memorandum copy. Destroy when 3 years old (GRS 9/11b)
- b. Obligation copy. Destroy when funds are obligated (GRS 9/11c)
- c. Unused ticket redemption forms, i.e., SF1170. Destroy when no longer needed for administrative use. (GRS 9/11d)

174. Contract Books Contract files consisting of: Reimbursement or Advance of Funds Agreement, Purchase Order, Request for Data Files and Tabulating Routines, Memorandum, Supply Equipment or Service Order, Correspondence, Vouchers, and the like.

Retention Period.

- a. Transaction of more than ~~\$10,000~~ ^{25,000} and all construction contracts exceeding \$2,000. Destroy 6 years and 3 months after final payment. (GRS 3/3a) *TRANSFER TO THE WNRC 3 years after 25,000 final payment.*
- b. Transactions of ~~\$10,000~~ or less and construction contracts under \$2,000. Destroy 3 years after final payment. (GRS 3/3b)

175. Accounts Receivable. File consists of: Collection Voucher (SF1114), Purchase Order Voucher, Xerox copy of treasury check, memorandum, reimbursement, Bill of Collection and Voucher, and Schedule of Withdrawals and Credits.

Retention Period. Transfer to the WNRC 3 years after period covered by the account. Destroy 6 years and 3 months after period covered by the account (GRS 6, Item 1(a)).

176. Batch Proofing/Listing Files. These are intermediate hard copy and computer runs that are produced as part of the process for preparing the Detailed Fund Reports that are used to check the data stored in the computer and the accuracy of input and machine operations. File contains transaction computer listings and voucher and schedule of payment memorandums.

Retention Period. Destroy when no longer needed for current business.

177. Technical Reference - Working File. These files consist of copies of: Decisions of the Comptroller General, TFPM Bulletins, computer system user manuals, reading files, and the like.

Retention Period. Destroy when superseded, obsolete, or no longer needed for current business.

178. Allocations and Allotments for Consolidated Working Funds. File consists of Notification and Approval of Fund Allotment (DL-1-183), Collection Voucher, and Xerox copies of checks payable to the Government.

Retention Period. Transfer to the WNRC 3 years after the close of the fiscal year involved. Destroy 6 years and 3 months after the close of the fiscal year involved (GRS 6, Item 1(a)).

179. Purchase Order - Closed File. File consists of Purchase Orders (DL-1-90) filed in P.O. number order.

Retention Period.

- a. Transactions more than ~~\$10,000~~ ²⁵. Destroy 6 years and 3 months after final payment. GRS 3/3a *✓ TRANSFER TO THE WNRC 3 years after final payment.*
- b. Transactions less than ~~\$10,000~~ ²⁵. Destroy 3 years after final payment. GRS 3/3b

180. LMI Cooperative Agreements. File consists of LMI Cooperative Agreements, Requests for Signature Sheet, Closeout Review Form, Voucher

Payment Record, Financial Reconciliation Worksheet, Letter of Credit, Cash Outlay Plan, and Contract Obligation Form. Other cross-reference and working files include: Batch Support Material and Checklists 1984-1987, Daily Support Listings of TFCS Payments (Computer listing), Cooperative Statistics Financial Report (CSFR), Rejection Letter File, Statement of Transactions, and the like.

Retention Period. Transfer to the ~~WRC~~ 3 years after period covered by Agreement. ~~Destroy~~ 6 years and 3 months after period covered by Agreement.

181. Time and Attendance Report Files. File consists of official copy of Time and Attendance Report Card--for current and inactive BLS personnel.

Retention Period. Destroy after GAO audit or when 3 years old, whichever is sooner. (GRS 2/3a)

182. Working Papers Files - Division Wide. This file consists of working papers maintained by staff members, consisting of extra copies of documents, drafts, computer reports, financial reports, daily working files, and other working papers retained for convenience.

Retention Period. Destroy when superseded or no longer needed for current business, whichever comes sooner.

DIVISION OF ADMINISTRATIVE SERVICES

- a. Mission. To plan and direct the Bureau's administrative services activities.
- b. Functions.
 - (1) Provides general services for the Bureau including property management, supplies and equipment procurement, administrative printing, as well as space allocation and control functions.
 - (2) Develops and maintains administrative forms management programs, records, and correspondence filing and control system; provides communications and mail distribution services.
 - (3) Administers the Bureau's safety program.
 - (4) Develops policy and procedures for the management of the BLS contracting program.

183. Division Administrative and Program Subject Files. Files are maintained by the secretary for the Division of Administrative Services. They contain incoming and outgoing correspondence, memoranda, and like documentation pertaining to housekeeping and program affairs and functions such as: Awards, Organization, Meetings, Financial Management, Office Services, Space, Personnel, Procurement, Public Information, Reports and Travel and Transportation.

Retention Period. Destroy when 5 years old or when no longer needed for current business, whichever is later. Files should be reviewed at least annually to dispose of nonrecord items, such as reference material.

184. Name Personnel File. This file consists of copies of employee address forms, performance standards and appraisals, notification of personnel action (SF50B), investigation reports, annual employee reviews, performance requirements and evaluations, request for personnel action, and the like; i.e., correspondence and memoranda pertaining to employees of the Division. *DEVIATES FROM GRS1/14a*

Retention Period. Destroy 3 years after transfer or separation of the subject employee. 

185. Employee Leave Record File. File consists of the Employee Leave Record (DL-1-107-B) maintained for Division employees, filed by year and alphabetically. Also included is the Daily Report of Leave Taken, Attendance, and Absences.

Retention Period. Destroy when 3 years old. *(GRS219)*

186. Flexitime Record-File. File consists of the original Flexitime Record (DL-1-2008) files by year and alphabetically by employee name.

Retention Period. Destroy 3 years after transfer or separation of the subject employee.

DEVIATES
FROM
GRS 2/30

187. Time and Attendance Report Files. File consist of a copy of the time and Attendance Report Card - for both current and inactive division assigned employees.

Retention Period. Destroy 3 years after transfer of separation of employee.

DEVIATES
FROM
GRS 2/3

188. Reference - Working Files - Division Wide. Supervisory, professional and support employees maintain extra copies, printed material, computer printouts and the like, covering areas in their assigned program areas.

Retention Period. Destroy when no longer needed for current business.

189. Technical Reference Files. These files consist of copies of selected volumes of the CFR (Code of Federal Regulations), system manual, technical manuals, procedures and the like.

Retention Period. Destroy when superseded, obsolete or no longer needed for current business.

190. Forms File. File consists of record copies of forms created by the BLS organization with related material. Example: BLS Facility Service Request OAM-165.

Retention Period. Destroy 5 years after related form is discontinued, suspended or cancelled.

191. Working Files - Division-wide. In carrying out their duties, supervisory, professional and support employees maintain extra copies of correspondence, reports, printed material, computer printouts, and the like material covering areas in their assigned programs and duties.

Retention Period. Destroy when no longer needed for current business. Also, review files at least once a year to identify disposable material.

BRANCH OF RECORDS MANAGEMENT AND GENERAL SERVICES

b. Functions.

(1) Plans, develops, and coordinates an integrated Bureau records management program including:

a. An administrative forms and correspondence control system that provides for the preparation and review of all administrative forms and correspondence.

- b. A records disposition and storage system that provides for the development and execution of record retention and disposal schedules within the Bureau and the development of filing systems to meet Bureau requirements.
- (2) Develops and maintains the Bureau's record and office security program in accordance with Departmental and Government-wide policy. Maintains records at the Departmental secondary Emergency Relocation Center.
 - (3) Develops and conducts the Bureau's safety program. Maintains liaison with Departmental counterparts.
 - (4) Provides services essential to the receipt and dispatch of mail services, and Telecommunication services.
 - (5) Provides transportation services for bulk items and mail and messenger services between the Bureau's office locations.

192. Records Disposition Files. Files consist of approved and pending approval, Records Retention Schedules for the Offices within the BLS organization. Related files include transmittals to WRNC, inventory sheets, correspondence and similar material.

Retention Period. Destroy ^{1 year after} when related records are destroyed, or transferred to the National Archives, or when no longer needed for administrative or reference purposes. (GRS 16/2a)

193. Branch Program Subject File. Alphabetical program file for the Branch of Records and Mail, relating to: Budget Projections, training, feasibility studies, other studies and surveys, personnel, and general correspondence and the like.

- a. Division Budget Projections. Destroy 3 years after the close of the fiscal year.
- b. All Other Records. Destroy when 5 years old or when no longer needed for current business, whichever is later. Files should be reviewed at least annually to dispose of non-record items, such as reference material.

194. Imprest Fund File. File consists of Cash Account Log Books and Ledgers, Accountability and Reimbursement Voucher Reports, Fare Cards, related correspondence and the like.

Retention Period. Destroy 6 years and 3 months after period covered by account. ^{Transfer to the WRNC 3 years after period covered.} (GRS 6/1a)

195. Safety and Health Program. Files consist of the following:

- a. Air sampling reports, log books, and related correspondence;
- b. Log of Federal Occupational Injuries and Illnesses and the related Safety and Health manager copy of the DL1-440, Report of Accidents, Injuries and Illnesses;

- c. Safety and Health Inspection Reports and related correspondence;
and
- d. DLI-1097, Report of Unsafe and Unhealthful Conditions, log book,
and related correspondence.

Retention Period. [REDACTED]

- a. All Asbestos-Related Records, including records which may be found in 195 b-d. Transfer to the WNRC when 5 years old. Destroy when 30 years old.
- b. Log of Federal Occupational Injuries and Illness, DL 1-440, Supervisors Report of Accidents, Injuries and Illness. Transfer to the WNRC when 3 years old. Destroy 5 years after the period covered.
- c. Safety and Health Inspection Reports and related correspondence. Transfer to the WNRC when 3 years old. Destroy 5 years after the period covered.
- d. DL 1-1097, Report of Unsafe and Unhealthful Working Conditions, log book and related correspondence. Transfer to the WNRC when 3 years old. Destroy 5 years after the period covered.

196. Key Accountability and Security File. Files related to accountability keys issued and for safe and padlock combinations, names of individuals knowing combinations, and comparable data used to control access to division areas.

Retention Period.

- a. Areas under maximum security. Destroy 3 years after turn-in of key (GRS 18, Item 16(a)).
- b. All other areas. Destroy 6 months after turn-in of key (GRS 18, Item 16(b)).

197. Physical Security Program. This file consists of reports such as incidents, complaints; correspondence, alarm systems, building access control, card access systems, property pass system, equipment and supplies and the like.

Retention Period.

- a. Visitor Control Files. Transfer to the WNRC 3 years after the period covered. Destroy 5 years after period covered (GRS 18, Item 17(a)).
- b. Guard Assignment Files. Destroy 2 years after period covered (GRS 18, Item 13(b)).
- c. Guard Service Control Files. Destroy when 1 year old (GRS 18, Item 19(b)).
- d. Security Violation Files. Destroy 5 years after close of case (GRS 18, Item 24(a)).
- e. Administrative Correspondence Files. Destroy when 2 years old (GRS 18, Item 8).

198. Mail Management Files. Files consist of mail reports, analysis reports, quarterly penalty mail, metered mail, budgets and related correspondence.

- a. Penalty Mail Reports. Transfer to the WNRC 3 years after the period covered. Destroy 6 years after the period covered (GRS 12, Item 7).
- b. All Other Correspondence, Analyses and Reports. Destroy 3 years after period covered.

199. Postal Records - Mail Room. Files consist of logs relating to incoming and outgoing registered, certified insured, and special delivery including receipts and return receipts and the like material.

Retention Period. Destroy when 1 year old. See GRS Schedule 12, Items 5 and 6, for detailed disposition descriptions and authorizations.

200. Mailing Lists - Mail Room. - Consists of specific mailing lists, for internal and external addressees.

Retention Period. Destroy when superseded by new mailing list.

201. Printing Requests w/distribution - Mail Room. File consist of the pink and green copies of the BLS/DOL Printing Request Form.

Retention Period. Destroy 3 years after completion or cancellation of requisition (GRS 3, Item 6(a)).

202. General Correspondence - Mail Room File consists of the Yellow Copy of all outgoing correspondence, filed in date order.

Retention Period. Destroy when 3 years old.

203. Archive Records File - Mail Room. This file consists of copies of SF-1375 Records (from WRNC), and correspondence related to the records

Retention Period. Destroy 1 year after records are destroyed, or transferred to the National Archives, or when no longer needed for administrative reference purposes, whichever is sooner. (GRS 16/2a)

204. Building Pass/Temporary I.D. Files. File consists of Building Pass/I.D. Cards (DL-1-7) for all BLS employees and contractor personnel.

Retention Period. Destroy upon separation or transfer of employee.

BRANCH OF PRINTING, PROCUREMENT, PROPERTY MANAGEMENT AND CONTRACTING

b. Functions

- (1) Controls and arranges for all administrative flatwork printing and/or provides duplicating services within the Bureau.
- (2) Conducts the Bureau's property management program and participates in equipment, property, and supply activities in conjunction with the OASA property management and inventory system.
- (3) Provides for the procurement of supplies, equipment, and services in support of the Bureau's mission in accordance with appropriate procurement and Departmental regulations and procedures.
- (4) Maintains adequate stock levels of supplies, equipment etc., for the Bureau.
- (5) Maintains BLS contracts and related files.

205. Printing Records - File consists of distribution lists, graphics requests, data logs for mail, duplication and reproduction, daily photocopying log, printing cost log, and mailing lists.

Retention Period. Destroy when superseded, obsolete, or when no longer needed.

206. Catalog Reference - File consists of a microfiche catalog file of Federal Supply Schedules, filed by microfiche number, and vendor/supplier catalogs in hardcopy.

Retention Period. Destroy when superseded, obsolete, or when no longer needed for current business.

207. Cash Purchase File - Files consist of original requisition, receipt for cash purchase voucher, and the like.

Retention Period. Destroy 3 years after final payment.

208. Requisition Issued from Stock - File consists of form: Requisition for Equipment and Supplies.

Retention Period. Destroy when 3 years old. (GRS 3/8a)

209. DPMS Transaction Form/Report of Survey File - File consists of completed copies of DL-1-1, Report of Survey, dealing with all serialized equipment.

Retention Period. Destroy 3 years after item is withdrawn from plant account. (GRS 3/9c)

210. Contract Employee Log Record DL-1-325 - File consists of Contract Employee Log Records for contractor moving services and the like. Maintained for verification of manhours worked by contractor.

Retention Period. Destroy when 3 years old.

211. "Working" BLS Contract File - File consists of copies of: Award/Contract for transactions of \$25,000 or more, file contains amendments, solicitations, modifications, and related correspondence; e.g., initiation letters. Included are both Active and Inactive Contract Files. Official record copy of contracts and associated records are located and maintained by DOL Office of Procurement.

Retention Period. *transfer to the UNRC 3 years after final payment.* Destroy 6 years and 3 months after final payment. (GRS 3/3a)

212. Purchase Order/Requisition - Files consists of purchase orders and requisitions for goods and services, transactions of \$10,000 or less, for maintenance on owned equipment, leased equipment, subscriptions file, cancelled equipment files, and division administrative. Contents of each file may contain purchase orders, requisitions, amendments, receipts, and the like.

Retention Period. (See GRS 3/3)

a. Procurement or purchase organization copy, and related papers.

(1) Transactions of more than \$²⁵~~10~~,000 and all construction contracts exceeding \$2,000.
Transfer to the UNRC 3 years after final payment.
 - Destroy 6 years and 3 months after final payment.

(2) Transactions of \$²⁵~~10~~,000 or less and construction contracts under \$2,000.

- Destroy 3 years after final payment. (Close file at the end of the fiscal year, retain 3 years and destroy, except that files on which actions are pending shall be brought

forward to the next fiscal year's files for destruction therewith).

- b. Obligation Copy - Destroy when funds are obligated.
- c. Other copies used for administrative purposes - Destroy upon termination or completion.

BRANCH OF SPACE, TELECOMMUNICATIONS AND FACILITIES MANAGEMENT

b. Functions

- (1) Space Management policy, planning and layout
- (2) ADP Security
- (3) Telecommunications policy, operations and management
- (4) Facilities operations and management
- (5) Building service/complaints
- (6) Facility related services

213. Master Space Floor Plan File. File consists of floor plans for each organization within BLS, files alphabetically by organization. Also included in this file are the space and facilities requirements file.

Retention Period. Destroy when plan is superseded, revised, obsolete or no longer needed for reference.

214. Technical and Working Files - Branch of Space. In carrying out their duties, such as developing space, equipment telephone, and related items to facilities management. Files consist of copies of telephone orders, space program records, service work order and the like material.

Retention Period. Review files at least once a year to identify disposable materials. Destroy when superseded, obsolete, or no longer needed for current business.

INSERT THE FOLLOWING

*ITEM 214.1: Agency Space Files. Records relating to the allocation, utilization, and release of space under agency control, and related reports to DOL and the General Services Administration.

Retention Period.

- a. Building plan files, surveys, and other records utilized in agency space planning, assignment, and adjustment. Destroy 2 years after termination of assignment, or when lease is cancelled, or when plans are superseded or obsolete (GRS 11, Item 2(a)).
- b. Correspondence with and reports to staff agencies relating to agency space holdings and requirements.
 1. Agency reports to DOL and GSA, including SF-81, Request for Space, and related documents. Destroy when 2 years old (GRS 11, Item 2(b)(1)).
 2. Copies of subordinated reporting units and related work papers. Destroy when 1 year old (GRS 11, Item 2(b)(2)).

*ITEM 214.2 Communication General Files. Principal records documenting telecommunication service control and operational records, and long distance and local telephone usage reports.

Retention Period.

- a. Telecommunications plans, reports and other records pertaining to equipment requests and service. Destroy when 3 years old (GRS 12, Item 2(b)).
- b. Telecommunications statistical reports including cost and volume data. Destroy when 1 year old (GRS 12, Item 2(c)).
- c. Records relating to installation, change, removal, and servicing of equipment. Destroy 2 years after expiration or cancellation of agreement (GRS 12, Item 2(d)(2)).

DIVISION OF MANAGEMENT SYSTEMS
BUREAU OF LABOR STATISTICS

- a. Mission. To develop, implement, and maintain administrative and program management systems for the Bureau.
- b. Functions.

The DMS workload is focused in ten major and essentially distinct areas:

1. Confidentiality policy.
2. OMB Circular No. A-76 studies
3. Productivity/Management Improvement
4. General legal and legislative review (employee ethics/conflict of interest, (legislation/regulation review, etc).
5. IRM (data collection clearances, ICB IRM reviews)
6. FOIA and Privacy Act Coordination
7. Internal Control Program
8. Office systems
9. Security Policies, Procedures, and implementation
10. Audit Coordination and Internal Investigations.

The Division also prepares or coordinates the preparation of miscellaneous other reports, documents, etc (e.g., Catalogue of Federal Domestic Assistance Programs, Report of participation on Federal committees). When priorities have demanded, it has conducted major management analysis studies (e.g., user fees; feasibility of regional office consolidation).

215. Division Program Subject Files. These files reflect actions relating to office automation projects, productivity improvement, general legal and legislative activities, internal control and security policies and procedures. Included in these files are: general correspondence, directives, audit reports, studies, standards, reports, procedures, evaluations, budget submissions and similar types of documents related to the abovementioned programs and activities.

Retention Period. Break files every 5 years and bring active material forward to the new files as required. Transfer to the WNRC when the latest record is 5 years old. Destroy inactive materials when the latest record is 10 years old.

216. Confidentiality Files. File consists of: BLS confidentiality legislation, interagency agreements, procedures, case histories, and the like. Also, general confidentiality files including; laws, regulations, legislation, training and relations with DOL; other federal agencies and individual states.

Retention Period. Break files every 5 years and bring active material forward to the new file as required. Destroy inactive materials when the latest record is 5 years old or when no longer needed for current business, whichever is sooner.

217. DOL Manual Series Files. Files consist of revisions to DOL manuals and the like. Distribution list is maintained by DMS. Sample manuals and procedures are Security Orders, Records Management, Personnel Management, Financial Management, Travel and Audit investigation.

Retention Period. Destroy when superseded, revised or no longer needed for current business.

218. Reading Files. Files consist of extra copies of correspondence prepared in Division of Administrative Services and Division of Management Systems, arranged by date, for the signature of officials of these organizations.

Retention Period. Transfer to the WNRC when 3 years old, or when no longer needed for current business. Destroy when 6 years old, [REDACTED]

219. Word Processing Diskettes File. File consists of word processing diskettes representing 30 days of office memorandums, office correspondence and the like. Files are backed up every 30 days. The files are maintained by the office's 3 word processing operators.

Retention Period. Correspondence is sorted by originator. Used in preparing hard copy documents such as correspondence and textual material for reports. Scratch when no longer needed for current business.

220. Acknowledgement Form File. File consists of individually signed acknowledgements by BLS employees regarding the handling of BLS Sensitive Information, records filed by cost center only.

Retention Period. Destroy 3 years after employee is transferred or released from government service.

221. Supervisor's Administrative File. File consists of copies of; Standard Training Form (SF101), Personnel Action Item (SF-52) and Office requisitions, relating to Division of Management Systems personnel and equipment.

Retention Period. Destroy when old or when no longer needed, whichever is sooner. Ref: GRS 23, Item 1.

222. Document Management System Files. The LAN system is currently undergoing testing and evaluation "pilot system," within the BLS Office of

Administration. It is supported by a "411" Document Retrieval and Security System software package, with full text storage and retrieval. Documents are received via electronic mail and transmitted. Files are placed into storage on the system and include: Operational Files, 1980-1985 and 1986-1990. Directives: Contracts; and Administrative Files

Retention Period. Electronic files will have similar retention periods to their hard copy equivalents, described in retention schedules under this organization, i.e., Office of Administration.

Magnetically recorded records that are retained for more than 5 years, on archival tape or diskettes shall be requested at 5 year intervals to ensure readability.

223. Reference-Working Files-Division Wide. The supervisory, professional and support employees maintain extra copies, printed material, computer printouts and other working files covering their particular assigned program areas. Also, maintained are BLS program manuals, user guides, as well as technical memoranda and other directives and issuances.

Retention Period. Destroy when no longer needed for current business.

ITEM 224: Freedom of Information Act Files. Files consist of copies of incoming and outgoing correspondence related to FOIA requests for information addressed to the Bureau. File maintained for control purposes only.

Retention Period.

- a. Correspondence and supporting documents (EXCLUDING the official file copy of the records requested if filed herein).
 1. Granting Access To All Requesting Records. Destroy 2 years after date of reply (GRS 14, Item 11(a)(1)).
 2. Responding to requests for non-existent records; to requesters who provide inadequate descriptions; and to those who fail to pay agency reproduction fees, where required.
 - a. Request not appealed. Destroy 2 years after date of reply (GRS 14, Item 11(2)(a)).
 - b. Request appealed. Destroy as authorized in Item 224.1 (GRS 14, Item 11(2)(b)).
 3. Denying Access to All or Part of the Records Requested.
 - a. Request not Appealed. Transfer to the WNRC when 3 years old. Destroy 6 years after date of reply (GRS 14, Item 11(3)(a)).
 - b. Request Appealed. Destroy as authorized in Item 224.1 (GRS 14, Item 11(3)(b)).
- b. Official File Copy of Requested Records. Destroy 5 years after final action by the agency or after final adjudication by courts, whichever is later (GRS 14, Item 11(b)).

*ITEM 224.1: FOIA Appeals Files. Files created in responding to administrative appeals under the FOIA for release of information denied by the agency.

Retention Period.

- a. Correspondence and supporting documents (EXCLUDING the file copy of the records under appeal if filed herein). Destroy 6 years after final determination by agency or 3 years after final adjudication by courts, or 6 years

after time at which a requester could file suit, whichever is later (GRS 14, Item 12(a)).

- b. Official File Copy of Records Under Appeal. Destroy 5 years after final action by the agency or after final adjudication by courts, whichever is later (GRS 14, Item 12(b)).

*ITEM 224.2 FOIA Control Files. Files maintained for control purposes in responding to requests, including registers and similar records listing date, nature, and purpose of request and name and address of requester.

Retention Period.

- a. Registers or Listings. Destroy 6 years after date of last entry (GRS 14, Item 13(a)).
- b. Other files. Transfer to the WNRC 3 years after final action by agency or after final adjudication by courts, whichever is later. Destroy 6 years after final action by agency or after final adjudication by courts, whichever is later (GRS 14, Item 13(b)).

225. Information Collection Budget/Information Collection Clearance (SF83) File - File consists of correspondence relating to requests for approval for information collection/burden hours. Examples of contents include: OMB Clearance, Request for OMB Review (SF 83), Concurrence for Clearance, review letters, summaries, instructions, forms, action sheets and the like.

Retention Period. Destroy when superseded, obsolete, or no longer needed for current business.

OFFICE OF TECHNOLOGY AND OPERATIONS REVIEW (OTOR)

INTRODUCTION

This paper was prepared to assist the Department of Labor management review of the proposed reorganization which would create the Office of Technology and Operations Review (OTOR). This new office would consist of five subordinate divisions: Automatic Data Processing Support (DADPS), Communications and Computing Machinery (DCCM), General Systems (DGS), Management Information systems (DMIS), and Systems Design (DSD). As part of this reorganization review, a question arose concerning the activities of the five divisions. While the Mission and Function documentation serves to identify major areas of responsibilities, it was viewed as too sterile to explain away some of the classifiers' concerns. Hence, this paper was written to describe a technology intensive activity in everyday terms in the hope that it will better explain any remaining ambiguities or misconceptions.

BACKGROUND

In June 1982, the Commissioner announced a proposed reorganization. One result was to create the Office of Administration and Internal Operations (OAIIO). The OAIIO is made up of the Offices of Administration, Statistical Processing, and Technology and Operations Review. The creation of OAIIO effectively joined administration with the data processing arm of the bureau to create a new Deputy level office. this new office is responsible for:

- ° Administration - including personnel, procurement, and financial affairs, and
- ° Internal Operation - including overseeing all survey specific and nonspecific computer usage as well as involvement in all internal BLS management issues normally of concern to the Commissioner.

As stated earlier, this reorganization created the Office of Technology and Operations Review (OTOR). The OTOR was established to increase the overall responsibilities of the former Office of Systems and Standards (OSS). Part of these additional responsibilities include providing direct support and consultation to the Deputy Commissioner for administration and Internal Operations (OAIIO) concerning technology or other activities involving internal operations.

In short, the role of the Assistant Commissioner for OTOR is to assist the deputy Commissioner in areas of internal operations through formal or informal assignment. Formal assignments are identified in the Office's Mission and Function Statement. Informal assignments are made through memorandum or orally.

Informal assignments may be far reaching and can involve this Office in any of the Bureau's work. These assignments are made by the Commissioner or Deputy Commissioner. the means to accomplish these assignments is determined by the nature of the assignment.

The purpose of this paper is to address how we in OTOR operate to carry out our formally assigned responsibilities. This will be done by describing the work done by the five Divisions making OTOR. For those not familiar with the Mission and Function Statements for these Divisions, referring to them would greatly increase your understanding of the following descriptions.

226. Assistant Commissioner Program and Administrative Subject Files - Files are maintained by the secretary for the Assistant Commissioner (OTOR). They contain files dealing with: ADP Policy, budget, conferences, contracts, flexitime, monthly progress reports, payroll, position management, procurement, reports, travel, and the like.

Transfer to the WARC when 3 years old.
Retention Period. Destroy when 5 years old, ~~or when no longer needed for current business, whichever is later.~~ Files should be reviewed at least annually to dispose of nonrecord items, such as reference material.

227. Name Personnel File - File consists of copies of performance standards and appraisals, notifications of personnel actions, annual employee reviews, correspondence, training, and the like.

Retention Period. Destroy 3 years after transfer or separation of the subject employee.

228. General Information File - File consists of correspondence; i.e., incoming and outgoing, memoranda, users manuals, reports and related material as they apply to individual office chiefs (Organizations).

Transfer to the WARC when 3 years old.
Retention Period. Destroy when 5 years old, ~~or when no longer needed for current business, whichever is later.~~ Files should be reviewed at least annually to dispose of nonrecord items, such as reference material.

229. Reference-Working Files - Office-wide - Supervisory, professional, and support personnel maintain extra copies of printed material computer printouts, handwritten notes, interim reports, analysis material, and the like.

Retention Period. Destroy when no longer needed for current business.

230. Technical Reference Files - These files consist of copies of reports, publications, instructions, regulations, technical manuals, and the like.

Retention Period. Destroy when superseded, obsolete, or when no longer needed for current business.

231. PC Computer Data File - Data file is utilized as a "Correspondence Tracking System" which logs in: correspondence, requisitions, travel vouchers, and the like by date received, addressee/responsible individual, and date due. Action correspondence filed by manager and/or type of correspondence.

Retention Period. Destroy when no longer needed for current business.

232. Budget and Financial File - File consists of draft and final reports of OTOR's annual budget reports including correspondence, working papers, and the like in the preparation of the OTOR operating budget.

Retention Period.

Transfer to WNRC when 3 years old.

a. Budget Policy File. Destroy when 5 years old.

b. Budget Estimates and Justification Files. Destroy when 5 years old.

Transfer to WNRC when 3 years old.

c. Budget Correspondence Files - destroy when 2 years old

d. Budget Background Records - Working Papers - Destroy 1 year after close of fiscal year covered by budget

e. Budget Report Files *Transfer to the WNRC when 3 years old.*

(1) Annual Report - Destroy when 5 years old

(2) All other - Destroy 3 years after end of fiscal year

f. Budget Apportionment Files - Destroy 2 years after close of fiscal year.

233. Contracts File - File consists of successful contracts with individual computer support contracts; e.g., Sigma Data, ATI, Optimum Systems, etc. to perform BLS-related activities including contract amendments, modifications, RFO, RFPs, financial reports, correspondence/memoranda, and COTR-related material.

Retention Period. Destroy when related contract is completed.

Division of Automatic Data Processing Support

The purpose of the Division of Automatic Data Processing Support is to provide maximum support to BLS Program, Project, and Regional Offices in all areas of BLS data processing. As a consequence, the DADPS is directly or indirectly involved in all major aspects of the Bureau's work. For example, this division handles contract monitoring responsibilities for several of the Bureau's major contracts: the labor hours contract with Sigma Data; the remote job entry facilities management contract with ADI; the computer center services contract with the Optimum Systems Division of EDS corporation; and the four data entry contracts with Descomp, Rehab, Card Ware, and ADI. One or more of these services are used by employees throughout the BLS without regard to profession, office, or geographic location.

In addition, this Division is responsible for all in-house ADP equipment, their operation and maintenance, supplies, and associated procurement requests, including the acquisition, set up, and use of computer terminals and modems. To assist other Bureau managers measure their use of the various ADP services available to them, the DADPS provides periodic reports concerning the status of funds reserved for ADP uses and actual use statistics of specific ADP resources. These reports provide management with information concerning their costs to use such services as mainframe computers, keypunch, labor hours contractors, terminals, etc.

Another important aspect of the DADPS' work is the support service it provides for LABSTAT, the Bureau's central repository of major labor statistics data. The DADPS handles all operations required to coordinate and integrate the Bureau's diverse data formats and dissimilar program focuses into a single data base that can be accessed commonly by all whom would use it. Also, data dissemination to the public is part of these overall LABSTAT responsibilities.

Lastly, among its duties not yet mentioned, the DADPS is also responsible for data security arrangements at our various remote computer sites as well as our in-house facilities. An elaborate system of keywords, controlled-access cards, and computer security software has been set in place to safeguard the Bureau's data. The DADPS monitors these security arrangements and through policing actions can identify transgressors and take corrective actions where problems occur.

ITEM 234: LABSTAT Data Files. BLS major time series data available on magnetic tape and maintained in the LABSTAT database for distribution to and access by the public.

Retention Period. Permanent. Data files within the LABSTAT database specifically identified by the National Archives and all file documentation will be transferred to the National Archives annually, or as specified by the Memorandum of Understanding to be established between the Bureau of Labor Statistics and the National Archives.

234.1 Update Request File - File consists of a LABSTAT Data Update Request Form (SO-72) which is used for updating the data base, and requesting data from the System.

Retention Period. Destroy when no longer needed for current business.

235. Contractor Request File - File consists of copies of request forms for specific information from the LABSTAT database, to be produced on magnetic tape 6250/1600 for specific customers.

Retention Period. Destroy when no longer needed for current business.

236. EDS Monthly Reports and Bills. File consists of computer usage information by organization and individual with associated hours of use and cost information, with associated EDS Billing Summary.

Retention Period. *✓ Transfer to the archive when 3 years old.* Destroy when 5 years old, or when no longer needed for current business, whichever is later.

237. NIH and EDS Current FY Account Registrations - File consists of a copy of the Account Registration Form, the file is in alphabetical order, filed by account initials/code, 4 digit alpha designator.

Retention Period. Destroy when no longer needed for current business.

238. Data Entry and Messenger Contract Bills - File consists of incoming and outgoing correspondence, Requests for Proposals (RFP's), invoices/billings, amendment of contracts, reports, and the like material.

Transfer to the WNRC when 3 years after period covered.
Retention Period. Destroy 6 years and 3 months after period covered by contract.

239. Monthly Reports and Bills - Files consist of computer usage information, by organization and individual and broken down by hours and cost with associated billings.

Transfer to the WNRC when 3 years old.
Retention Period. Destroy when 5 years old, or when no longer needed for current business, whichever is later.

240. Reference Files - Division Wide - The supervisory, professional, and support employees maintain extra copies, printed material, computer printouts, and other files covering their specific assigned areas. Also maintained are BLS program manuals, vendor manuals, user manuals, training manuals, and computer software packages, and other related material.

Retention Period. Destroy when no longer needed for current business.

241. Division Subject File - Subject file consists of correspondence, incoming/outgoing, reports personnel rosters, contracts, progress reports, supply records, notices and bulletins, and the like.

Transfer to the WNRC when 3 years old.
Retention Period. Destroy when 5 years old, or when no longer needed for current business, whichever is later. File should be reviewed at least annually to dispose of non-record items, such as reference material.

242. Working Papers Files - Division Wide - This file consists of working papers maintained by staff members, consisting of extra copies of documents, drafts, computer reports, financial reports, daily working files, and other working papers maintained/retained for convenience.

Retention Period. Destroy when superseded or no longer needed for current business, whichever comes sooner.

Division of Communications and Computer Technology

The current activities of the Division of Communications and Computer Technology (DCCT) have been concentrated in the following three areas:

1. Planning the establishment of an interim RJE capability for the BLS Regional offices
2. Planning the intermediate and long range structure of the BLS Communications Network
3. Conducting research into the communications and computer technology that is, or will be, available to meet the Bureau's communications and computing requirements.

While highly interrelated, these activities are sufficiently disjointed to justify separate discussion.

Given the uncertainties surrounding the future of the existing DOL Remote Terminal Network (RTN), we needed to take immediate action to ensure the continued access to RJE communication facilities for our Regional Offices. A DCCT task force was established and has spent much effort in identifying and evaluating the technical and procurement alternatives. It recommended that the Bureau procure its own RJE terminals. The recommendation was accepted by Bureau management, and we are now engaged in planning the installation of the new terminals.

While the RJE terminals to be rented will deal with the most immediate pressing problem, the Bureau's full requirements are far broader than just RJE communications. The main focus of DCCT has been to identify their full scope and to plan the organizational, technical, and procurement activities necessary to meet the full requirements. The DCCT Task Force is working to develop an RFP for at least two Local Area Networks (LAN) to be procured this fiscal year. They have spent a significant amount of time working with potential BLS users to develop the technical requirements and a plan for the organizational structure of the LAN environment. A design for the RFP procedures is one of the major outputs from this activity.

The focus in the second activity is on the Bureau's requirements for communications and interactive computing. The focus of the DCCT's third area of activity is on the computing machinery, the hardware and software, that is available to meet the Bureau's needs. This activity has consisted of intense study of a very dynamic part of the computing industry, small computers and local networks, and of contact with Government agencies and private firms that are active in the field. A very important area has been LAN technology with emphasis on the emerging National and Federal standards. Equally important has been the study of small computers, their interface with one another and with larger mainframe computers through gateways and standard protocols. The goal of this work is to validate the practicality of a multi-vendor network based on an open systems interconnection policy.

243. Division Program and Administrative Subject File - File consists of correspondence, flexitime, timekeeping, metro card, organization, personnel files by name, position descriptions, contracts, travel vouchers, training and various report files; progress, budget, staff utilization, and quarterly activity.

Transfer to the WNRC when 3 years old.
Retention Period. Destroy when 5 years old, ~~or when no longer needed for current business, whichever is later.~~ File should be reviewed at least annually to dispose of non-record items such as reference material.

ITEM 243.1. Project Overview Files. Files created at the end of a project, containing the basic documentation of the project and its conclusions and recommendations.

Retention Period. Permanent. Transfer to the WNRC when 1 cubic foot of records are accumulated. Transfer to the National Archives when the most recent record is 10 years old.

244. Division Contract Files - File consists of contracts, invoices, task orders, delivery orders, acknowledgements, and incoming and outgoing correspondence related to the Local Area Network (LAN) of the national office, regional office, labor hours, and graphic work stations including maintenance.

Retention Period.

- a. Transaction of more than \$~~25~~²⁵,000. Destroy 6 years 3 months after final payment. *Transfer to the WARC 3 years after final payment.*
- b. Transactions of \$~~10~~²⁵,000 or less. Destroy 3 years after final payment.

Ref: GRS-3, Item 3.

245. Problem Report Files - File consists of pink copy of the contractors Service Incident Report (MSD) form, used to report out of service computers (P.C.'s and other equipment).

Retention Period. Destroy when no longer needed for current business.

246. LAN Network System Files - File consists of LAN Network diskettes for system bootup, server diskettes, documentation and diskettes, user manuals, and the like material.

Retention Period. Destroy when superseded, obsolete, or when no longer needed for current business.

247. Division Wide Working Files - File consists of computer runs, memorandum, incoming and outgoing, correspondence, incoming and outgoing, flowcharts, record layouts, output definitions, run procedural instructions, and the like material.

Retention Period.

- a. Machine Readable System Documentation Files. Scratch when superseded, or one year after termination of the system, or whenever the related data tape files are scratched, as appropriate.
- b. Hard Copy Documentation. Record Copy. Destroy when obsolete or superseded or upon authorized destruction of related data base (GRS 20, Item 11).
- c. Other Hard Copy Documentation. Destroy when no longer needed for current business.

248. Division Wide Reference Material - File consists of users manuals, handbooks, instructions, regulations, catalogs, and the like material.

Retention Period. Destroy when no longer needed for current business.

Division of Systems Design

The Division of Systems Design has major responsibilities in the following four areas:

1. Coordination of the use of current technology in BLS systems
2. Contracting for computer-related products and services
3. Support of acquired software
4. Software support for the LABSTAT Data Base System

General functions in these areas are outlined below.

The Division of Systems Design (DSD) serves as a focal point for exchange of information among the Bureau's various systems operations units on software design and implementation, effective utilization of computer resources, and current developments in software engineering. This exchange is facilitated by task force efforts which provide technical support to specific development activities. A regular forum for exchange is provided by the Software Technology User's Group. This group of senior systems staff meets monthly to hear and discuss prepared presentations on technological advancements being made or applied in Bureau programs.

In contracting for computer-related products and services, including hardware, software, and training, DSD provides specialized knowledge of state-of-the-art approaches and assists the various project offices in defining and articulating requirements. DSD has primary responsibility for renegotiation of existing contract and procurement of new computer services. Currently, the DSD is involved in renegotiating our existing computer center contract. An effort involving all offices in the BLS and having an estimated cost to the Bureau of about \$20 million over the 5 year life of the contract. Working with the Project Offices, DSD identifies requirements for systems training and establishes the most efficacious means of meeting those requirements.

In the maintenance and effective utilization of acquired software, especially systems support software such as Data Base Management Systems, performance evaluation software, and software monitors, the Division provides liaison between the vendors, the computer operations centers, and the BLS user community. Specifically, DSD obtains and installs the software, distributes documentation, reviews all corrections and enhancements, selects those that are appropriate, and applies them to the software. DSD also develops and uses specialized evaluation techniques to monitor the performance of certain critical products. DSD provides consultation to BLS management and technical personnel on systems capabilities and limitations. DSD develops and carries out a standards program for all phases of the system life cycle, focusing its attention on software engineering as a discipline to be practiced by each project office.

The DSD designed the data base and developed the retrieval software for the Bureau's central data bank, LABSTAT. DSD develops and distributes documentation for the data base and software, including User's Guides, Series Directories, and MDL language manuals. DSD coordinates with Automatic Data Processing Support on the application of special updates to the data base, and on computer center changes which necessitate modifications to standard operating procedures. DSD develops and conducts training classes for LABSTAT users in BLS. The Division provides consultation to LABSTAT users in the BLS National and Regional Offices, State Employment Security agencies, and other

Federal agencies accessing the LABSTAT system at the National Institutes of Health, via the government-wide ADP Sharing Program.

249. Program and Administrative Subject Files - Consists of flexitime, overtime, performance appraisals, travel authorizations, vouchers, leave requests, meetings, personnel actions, training authority, and the like. Also ATA contracts, DBMS replacement, Data dictionary, EDS cost tape analysis, EDS laser print, LABSTAT, Local Area Network (LAN), microcomputers ORI Contracts, budget organization and security files.

✓ Transfer to the WARC when 3 years old.
Retention Period. Destroy when 5 years old ~~or when no longer needed for current business, whichever is later.~~ File should be reviewed at least annually to dispose of non-record items, such as reference material.

250. Systems Hardcopy Documentation File. File consists of systems users manuals, hardware and software excerpts, and the like.

Retention Period. Destroy one year after final discontinuance of the system.

251. "Chrono" File - File consists of "outgoing" memorandum files and associated reference material filed in chronological order. They are used as a convenient reference or to flag a due date.

Retention Period. Destroy when 1 year old.

252. Procurement/Requisition File - File consists of incoming and outgoing memorandum, requisition review forms, requisition for equipment, supplies, or services, DL-1-1, request for ADP procurement form, and the like.

✓ Transfer to the WARC when 3 years after final payment.
Retention Period. Destroy 6 years and 3 months after final payment.

253. Contract Billing and Invoice File - File consists mainly of EDS invoices, Public Voucher for Purchase, SF 1034, Invoice Supplement by month, and the like material.

✓ Transfer to the WARC 3 years after period covered.
Retention Period. Destroy 6 years and 3 months after period covered by account.

254. Table Producing Language System Files - File consists of 5 manuals: (1) Introduction to TPL, (2) TPL Language Guide, (3) Print Control Language Guide, (4) TPL Operations Guide, and (5) Create Table Language Guide, all version 6 editions. Also included in the file, correspondence, order forms, and consultation notes, including system magnetic tape.

Retention Period. Destroy one year after discontinuance of the system. Ref: GRS-20, [redacted] Item 11

255. Reference Files Division Wide - The supervisory, professional, and support employees maintain extra copies of printed material, computer printouts, and other files covering their specific assigned areas. Also maintained are BLS program manuals, vendor hardware and software manuals, user and training manuals, computer software packages, and other related material.

Retention Period. Destroy when no longer needed for current business.

256. Working Paper Files Division Wide - This file consists of working papers maintained by staff members, consisting of extra copies of documents, drafts, computer reports, financial reports, daily working files, and other working papers maintained/retained for convenience.

Retention Period. Destroy when superseded or no longer needed for current business, whichever comes sooner.

Division of Management Information Systems

The Division of Management Information Systems (DMIS) is responsible to the MIS program office for systems design, development and operation of the BLS Management Information System. The division collects, stores, and reports on data BLS managers require for financial, personnel, and program management.

The Bureau uses a unified approach to its MIS, with the management and operations activities centralized within organizational units dedicated solely to this function. The MIS program office is responsible for coordinating the development of information requirements, determining priorities, and managing the overall MIS development. The DMIS project office has responsibility for developing and operating the computer systems to meet these requirements.

The Bureau's MIS serves the Commissioner, members of her staff, office chiefs, and program and cost center managers. Most projects require DMIS to report to all managers described above.

Their information needs, however, differ since the Commissioner's Office wants only summary information for the whole Bureau, while at the other end of the spectrum, cost center managers need only see the unaggregated data relevant to their area.

The two requirements of the DMIS, to serve managers at all levels, and to produce timely reports are successfully met by relying heavily on state-of-the-art computer software and hardware. Data base management systems and non-procedural fourth-generation languages are used extensively. This approach reduces the time and staff resources required for application development. This use of advanced computer technology has been the most important factor in the success of the Bureau's MIS program, and now all levels of Bureau management consider the current and future products of the MIS program to be critical to their decision-making process.

257. Division Administrative Files - Files consist of time and attendance sheets, flexitime records, monthly activity reports, travel vouchers, computer account charge and terminal costs records, and the like.

Retention Period. *✓ Transfer to the UNRC when 3 years old.* Destroy when 5 years old, ~~or when no longer needed for current business, whichever is later.~~ File should be reviewed at least annually to dispose of non-record items, such as reference material.

258. BLS Time Distribution Sheets - File consists of all BLDS offices Time Distribution Sheets for entry into the MIS data base. Filed by month and fiscal year.

Retention Period. Destroy when no longer needed for current business.

259. MIS Reports (Scheduled and Ad Hoc) - Files consist of scheduled and ad hoc MIS reports, i.e., scheduled - BLS totals, budget activity, office totals, program totals, and cost center totals; also ad hoc reports - employee position information, budget position control book, interim position control system report, and the like.

Retention Period. Destroy when no longer needed for current business.

260. Division Wide Working Files - Files consist of computer printouts, incoming and outgoing correspondence, record layouts, output definitions, run procedural instructions, and the like material.

Retention Period.

- a. Machine Readable System Documentation Files. Scratch when superseded or one year after termination of the system, or whenever the related data tape files are scratched, as appropriate.
- b. Hard Copy Documentation. Record Copy. Destroy when obsolete or superseded or upon authorized destruction of related data base (GRS 20, Item 11).
- c. Other Hard Copy Documentation. Destroy when no longer needed for current business.

261. Division Wide Reference Materials - Files consist of users manuals, handbooks, instructions, regulations, catalogs, textbooks, and the like material.

Retention Period. Destroy when no longer needed for current business.

262. MIS System Documentation - File consists of MIS system documentation, i.e., data dictionaries, MIS file descriptions, data verification reports, system changes, and the like material.

Retention Period.

- a. Documentation Package. Data dictionary, flow charts, edit programs, update programs, error list and the like. Destroy when obsolete or superseded or upon authorized destruction of related data base (GRS 20, Item 11).
- b. Machine Readable and Printout Program Files. Scratch or destroy when superseded or one year after termination of the applicable system.

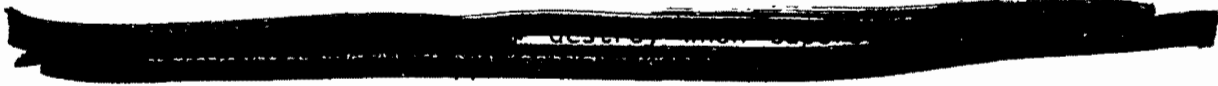

c. Tape Backup Files

Retention Period. Scratch when superseded by next backup.

MISSION AND FUNCTION STATEMENT FOR OFFICE OF PUBLICATIONS**OFFICE OF PUBLICATIONS**a. Mission

Acts for the Commissioner in planning and directing an integrated publication and information program to provide for and maximize the dissemination and utilization of the Bureau's statistical materials and research findings.

b. Functions

- (1) Provides leadership and policy direction for a comprehensive publication program of economic and statistical research and analysis.
- (2) Determines standards and quality control for Bureau publications and provides leadership and guidance to participating authors.
- (3) Develops and/or reviews publication plans for each fiscal year and provides long-range planning on Bureau publications.
- (4) Publishes the Bureau's periodicals, including the Monthly Labor Review, Occupational Outlook Quarterly, Employment and Earnings, Current Wage Developments, Producer Price Indexes, and CPI Detailed Report. Reviews, approves, and publishes bulletins, reports and other studies prepared by the Bureau.
- (5) Conducts research for the preparation of articles and pamphlets that will produce a balanced publications program reflecting the full range of Bureau activities.
- (6) Reviews the use of funds for printing of Bureau material.
- (7) Provides typesetting, computer charting, and other production services for the publication of Bureau studies and reports.
- (8) Develops and maintains a comprehensive information program. Edits and approves press releases. Answers queries from the public. Distributes free materials.
- (9) Serve as the Bureau's press liaison office, including clearance of releases with the Department's Office of Information.
- (10) Assists in the policy review of official Bureau correspondence originating outside the Commissioner's Office.
- (11) Advises regional offices and reviews selected regional publications and releases.
- (12) Participates with the Commissioner in the formulation of Bureau policy; serves on the Management Committee.

OFFICE OF THE CHIEF (ASSOCIATE COMMISSIONER)
OFFICE OF PUBLICATIONS

263. Associate Commissioner's Program - Administrative Management Subject Files. This file contains records pertaining to the conduct of ongoing administrative/management responsibilities and activities carried on by the Office of the Chief of Publications. Examples of subjects addressed by the records include: budgets, travel, inter-agency committee meetings (agencies notes, schedules etc.), general correspondence, project and article reports, policy directives, press release correspondence, region office reports, time and attendance records and division personnel name files.

Retention Period.

Program and Administrative Management Subject Files.

- a. Break files every 5 years. Bring current materials forward to new files. Destroy when 5 years old or when no longer needed for current business, whichever occurs first, except:
 - 1a. Personnel Name Files. Destroy 1 year after separation or transfer of employee.
 - C.B. Time and Attendance - Flexitime Files. Destroy when 3 years old.

264. Manuscripts File. Contains pending and rejected article manuscript drafts with editorial notes and action memos concerning changes, author approval, timing, etc.

Retention Period. Screen files annually, bring forward unpublished manuscripts still under consideration. Transfer for manuscript files of published articles and inactive unpublished article manuscript files to the Washington National Records Center when 3 years old. WNRC will destroy 5 years after year in which file was received.

265. Printing Specifications and Costing Data Base Files. A computerized data base that maintains records relating to: printing specifications and costs for BLS i.e., article size, number of pages, number of copies issued, originating program office and where printed (GPO or in-house) and production scheduling. Records used to reflect BLS programs printing activity by fiscal year. The data base is further used to generate analysis and planning reports used in program costs effectiveness planning, budget planning and for DOL and congressional reporting.

Additionally, the data base provides selected data on request (monthly), to the Bureau's MIS "profile reports" system.

a. Electronic Files. Maintain 3 years of data online and retain cumulative history offline for 7 years. Transfer to the WNRC when the latest record is 7 years old. Destroy when 10 years old, or when no longer needed for current business, whichever is sooner.

b. Coding Sheets. Destroy when no longer needed to support the reconstruction of, or serve as the backup to, the master file, whichever is later (GRS 20, Item 2(a)).

266. Monthly Labor Review Reference File.

Retention Schedule. - (non record) destroy when no longer needed for current business or when superseded.

267. Current Publications and News Release Reference File.

Retention Schedule. - Destroy when no longer needed for current business or when superseded.

The (Associate Commissioner) Chief of Publications also services as the Special Assistant to the Commissioner for the Labor Research Advisory Council (LRAC). The Chief of Publications' Administrative Office maintains the following LRAC records in the Office of Publications.

268. Labor Research Advisory Council Meeting Minutes File. Contains record copies of Transcribed minutes of council meetings concerning council discussions regarding BLS policies and direction. Also includes special topic subcommittee meeting minutes. Examples of Special Subcommittee titles would be:

- Wages and Industrial Relations Subcommittee
- CPI and WPI Finding Review Subcommittee
- Employment, Productivity and Technology Subcommittee
- Safety and Health Subcommittee

Retention Period.

a. Record Copy. Permanent. Break files at least every 5 years. Transfer council minutes files to the WNRC when 10 years old. Offer for transfer to the Archives of the United States in 10 year blocks when the most recent record is 20 years old.

b. All Other Copies. Destroy when 3 years old or when no longer needed for current business.

ITEM 269: RESERVED.

270. Labor Research Advisory Council Membership Files. Consists of letters of nomination, letters of selection and invitation, brief background and position description data sheets for each advisory council member back to 1982.

Retention Period. Permanent. Break files annually, bring forward current/renewed membership records. Transfer inactive membership files to the Washington National Records Center when 10 years old. Offer for transfer to the Archives of the United States in 10 year blocks when the most recent record is 20 years old.

271. LRAC/BLS Administrative Subject Files. Consisting of LRAC committee reports. Travel records, correspondence, DOL Reports and BLS special project reports. ~~1960-1984~~ PRESENT
1956

Retention Period. Screen files to separate committee/council reports and related records documenting the accomplishments of the committee/council from general administrative subject files and non-record reference copies of DOL and BLS reports.

- a. Council Report Files - Permanent. Break files at least every 5 years. Transfer other committee reports and related records to the Washington National Records Center when 10 years old, offer for transfer to the Archives of the United States in 10 year blocks when the most recent record is 20 years old.
- b. LRAC general administrative subject files. Break files annually, destroy when 2 years old or when no longer needed, whichever is sooner.
- c. Non-record reference copies of DOL and BLS special project reports destroy when superseded or no longer needed for administrative or reference purposes.

272. International Labor Organization (ILO) Technical Reference Files. Records monitor ILO activities and document BLS interaction from 1958-1984. Files include, conference meeting notes, article clippings and BL responses to requests for information.

Retention Period. Review annually and destroy material at no further reference value.

273. Long Shoreman Reading/Clippings File. 1962-1970 to include; long-shoreman article clippings, copies of past contracts and reference books or marine terminal operations and dock workers.

Retention Period. Review annually and destroy material of no further reference value.

274. Maritime Union Technical Reference Files. From 1961 to 1977 consisting of grievience committee notes, union issues reports working papers, news clippings, merchant marine hearing notes regarding labor/management relations and meeting minutes of the Presidents Maritime Advisory Committee (PMAC).

Retention Period. Review annually and destroy material of no further reference value.

DIVISION OF INFORMATION SERVICES**a. Mission**

To plan and direct the dissemination of information resulting from the Bureau's economic and statistical research programs in consultation with program offices.

b. Functions

- (1) Develops informational services for disseminating the results of the Bureau's statistical research to the public.
- (2) Maintains liaison with the Department's Office of Information and Public Affairs and with the Bureau's program and regional offices to assure coordination of information programs.
- (3) Conducts marketing activities to identify appropriate audiences for information about BLS products and to advise program offices on methods and techniques to publicize the results of their research efforts.
- (4) Develops informational materials to advise various BLS publics of the availability, location, and use of BLS products.
- (5) Provides data user services, conducts data user seminars, and develops consumer information materials.
- (6) Coordinates the updating of BLS information in reports published by other agencies.
- (7) Provides exhibits and related BLS informational services for national conventions bearing on labor economics.
- (8) Provides liaison for the maintenance of mailing lists.
- (9) Maintains a complete library of BLS public information publications.
- (10) Controls the inventory of all BLS bulletins and reports not sold by the Superintendent of Documents.

275. Division Chief- Program Administrative Files. Program administrative files include readership surveys, sales reports from GPO, NTIS and EDS, program bulletins, and correspondence concerning responses to inquiries concerning (price, productivity, employment etc.) the Bureau's data and programs.

Retention Period. Break file at least every five years and bring active material forward. Destroy when five years old or when no longer needed for current business, whichever is sooner.

ITEM 275.1 BLS Publications File. One copy of each BLS publication, including press releases, the Monthly Labor Review, all BLS Numbered Bulletins, reports, and other publications.

Retention Period. Permanent. Break file at the end of the calendar year. Retire to the WNRC. Transfer to the national Archives in 5 year blocks when 10 years old.

276. News Clipping Morning Report Files. Computerbased, electronically transmitted news clipping report transmitted to interested (listed) departments in BLS, DOL and other Government agencies.

Retention Period. Review annually and destroy material of no further reference value.

277. Electronic News Release Transmission File. Electronic copies of four major BLS news releases issued monthly two concerning price, two employment, and earnings. Transmitted to Electronic Data Services (EDS) for sales and distribution.

Retention Period. Delete when no longer needed for current business, superseded or obsolete.

278. News Releases Record Copies.

Retention Period. Screen to identify news releases written by Office of Publications, Division of Information Services personnel (to include news releases written by other Office of Publications personnel and edited by Information services personnel). Separate from copies of news releases originated in other offices.

- a. News releases originated from the Office of Publications. Include one copy of each news release in the series of publications to be transferred to the National Archives (Item 275.1).
- b. All other copies of news releases destroy when no longer needed for reference purposes.

279. Information Request Correspondence File. Electronically stored responses by the Division Chief to information inquiries by concerned publics regarding BLS announcements, etc.

Retention Period. Destroy when 3 months old or no longer needed, whichever is sooner. (GRS 14/11)

280. Press Officers Information/Project Subject Files. Consisting of CPI subscribers' survey reports, press release working papers, article correspondence, media contact lists, release date listings and project working papers and project reports.

Retention Period. Break files at least every 5 years, screen file to separate information files from project files. Bring forward information files pertinent to current business.

- a. Information subject files. Destroy when 5 years old, superseded or obsolete, whichever is sooner.

- b. Project working papers. Destroy 1 year after the year in which the project is closed.
- c. Project reports. Destroy when 5 years old, superceded or obsolete, whichever is sooner.

281. Information Services Reference File. Containing published directories, abstracts, etc. and distribution/reference copies of advisory commission reports.

Retention Period. Destroy when superceded or obsolete.

282. DOL Annual Report Working Papers File. Contains working papers and copies of previously released DOL annual reports with edited sections concerning BLS communications functions. Records used to develop upcoming DOL annual report sections that relate to BLS communication plans and activities.

Retention Period. Destroy 2 years after the close of the fiscal year covered by the annual report for which the working papers were maintained.

283. Press Release Technical Reference Files. Files contain interview transcripts, copies of speeches by BLS commissioners, and copies of reports presented to the President by the DOL Secretary that were released to the press or to interested audiences with associated cover letters, morning reports, working papers and photo prints. Records used for reference purposes, so as to maintain a consistency of responses to information inquiries.

Retention Period. Review annually and destroy material of no further reference value.

DIVISION OF PRODUCTION SERVICESa. Mission

To provide guidance, production services and administrative support in the design and production of all Bureau publications, thereby assuring readability, economy, and conformity with Federal printing regulations.

b. Functions

- (1) Copy edits manuscripts and other material submitted for publications in the Monthly Labor Review and other BLS publications, insuring accuracy and conformity with BLS and GPO regulations.
- (2) Prepares manuscripts for the printer, provides layout (or page makeup), proofreading, and other support services for publications typeset outside the Bureau.
- (3) Reviews all printing requisitions for accuracy and correctness of specifications, reviews distribution forms for accuracy, assembles and checks all required documents relating to production of a publication.
- (4) Forwards all work for printing either directly to contractor, through the department's printing procurement office to GPO, or through the Bureau's administrative office to the Department's printing facility.
- (5) Maintains liaison with contractors, the Department's printing procurement office, and the Bureau's administrative office, for the establishment and maintenance of printing schedules.
- (6) Monitors printing contracts for contractor compliance.
- (7) Determines format, sets type, produces charts, and prepares camera copy for all work produced in-house.
- (8) Determines format and prepares input for photocomposition done outside of the Bureau.
- (9) Determines acceptability of computer print-out or other material submitted for use as camera copy.

284. In House/Printing Production Requisition File. Contains copy of in house (DOL) production print orders with specifications and completed requisition form #DL-1-72, also includes distribution lists with quantities for each distribution filed numerically by BLS # sequence/article title from FY 1984 to 1987.

Retention Period. Destroy 3 years after close of fiscal year in which printed.

285. Contracted Printing/Production Requisition File. Contains copy of print orders with specifications, issued to selected printer (contractor). Print order references specific purchase order number. File also includes comments sheet and distribution list. Filed alphabetically by publication/article title, from FY 1984 - 1987.

Retention Period. Destroy 3 years after close of fiscal year in which printed.

286. Government Printing Office (GPO) Printing/Production Requisition File. Includes copy of print order with specifications, completed requisition form #DL-1-72 and distribution lists. Filed numerically by BLS # sequence, from FY 1984 - 1987.

Retention Period. Destroy 3 years after close of fiscal year in which printed. (GRS 3/6a)

287. Administrative Correspondence File. Contains copies of general administrative memos and letters distributed internally (within the bureau) and external incoming and outgoing administrative correspondence. Filed chronologically from 1977-1987.

Retention Period. Destroy when 2 years old.

288. Administrative Subject Files. Files include, employee training requests, leave requests, personnel action requests, travel expense requests, equipment and property inventory reports, budgets, memos and time and attendance sheets from 1982 to 1987.

Retention Period. Break files at least every 5 years and bring currently used materials forward to new files. Destroy when 5 years old or no longer needed for current business whichever occurs first, except:

- a. Personnel Name Files. Destroy 1 year after separation or transfer of employees.
- b. Time and Attendance Records. Destroy when 3 years old.

289. Division Personnel (Employee Name) Files. Contains employee time and attendance records, performance reviews, requests for leave and training programs completed. Filed alphabetically by employee name 1986 - 1987. (Newly created file separates certain personnel records previously maintained as a part of the administrative subject file cited as item 289 of this schedule.)

Retention Period.

- a. Personal Name Files. Destroy 1 year after separation or transfer of employee.
- b. Time and Attendance Records. Destroy when 3 years old.

290. Project Detail Reports File. Computer generated job costing reports regarding staff utilization and accrued hours/costs. Reports generated monthly and filed by fiscal year. Reports generated for FY 82 and 83, then reports stopped for 84, 85 and 86 then restarted for FY 87.

Retention Period. Destroy when 3 years old.

291. Graphics Files, Area Wage Survey (AWS) Publications. File contains original artwork and camera-ready copies of geographic area maps, charts and drawings used in the production of survey reports. Filed by geographic area, from 1981 to 1987.

Retention Period. Destroy 1 year after final publication or when no longer needed for publication or reprinting.

292. Graphics Files, Other BLS Publications. Files contain camera ready copies and photo negatives or graphic art used on BLS publications. Filed by type of publication ie; Bullentins, Reports, Article Reprints, Periodicals etc. and then by requisition number within each type of publication.

Retention Period. Destroy 1 year after final publication or when no longer needed for publication or reprinting.

293. MLR Article Text and Graphics Proofing File. Files include article gallys and camera ready copies of graphs and charts used in MLR articles. Files also include some cover graphics negatives.

Retention Period. Screen files and transfer any original art works, camera ready graphic copies or graphics photo negatives to graphics files. Destroy article gallys 1 year after publication of article.

294. Weekly Graphics Production Scheduling Database Files. Computer based system tracks disposition of graphics work contracted out. Hard copy reports issued weekly, updates to system batched and entered weekly. Returned hard copy reports destroyed after weekly system update.

Retention Period. Delete at close of fiscal year in which graphics contract is completed.

295. Publications Technical Reference Report Files. Files contain copies of reports prepared by BLS program offices (program offices maintain record copies) and printed by the Office of Publications. Files include the following reports:

<u>Title of Report</u>	<u>Inclusive Dates</u>	<u>Volume in Cubic Feet</u>
a. <u>Whole Sale Price Index Reports.</u> to include trend studies for major primary industries	1937-1953	1.0

b.	<u>Cost of Living Reports.</u> 1925-1953 to include family "budget" reports, changes to CPI calculations and purchasing power reports.	4.0	
c.	<u>Productivity Reports.</u> 1949-1963	1.0	
d.	<u>Foreign Labor Information Reports.</u>	1952-1962	1.0
e.	<u>Wholesale Price Index Reports.</u>	1931-1967	3.5
f.	<u>Consumer Price Index Reports.</u>	1973-1975	1.0
g.	<u>Real Earnings Reports.</u> 1972-1984	1.0	
h.	<u>Productivity and Cost Reports.</u>	1971-1984	1.0
i.	<u>Retail Food Price Reports.</u>	1952-1977	1.0
j.	<u>Employment and Labor Force Development Reports</u> Includes reports and associated news releases for reports regarding various employment topics.	1935-1984	4.0
k.	<u>CPI Cost of Living Reports.</u> Reports to include purchasing power of the dollar reports.	1890-1967	1.0
l.	<u>CPI, Special Subject Articles and Reports Series.</u>	1918-1958	3.0
m.	<u>Work Stoppage Reports.</u> 1971-1980	10.0	
n.	<u>Special BLS/DOL Reports.</u> 1974-1979 Regarding CPI findings and special studies carried out by BLS or DOL.	1.5	
o.	<u>Union Wage Scale Reports.</u> Geographic arrangement of wage scale reports by sample cities.	1892-1894	1.0
p.	<u>Annual and Special Reports to Congress.</u> copies of reports by Department of Labor to Congress to include U.S. Census (1970-1890).	1892-1894	1.0
q.	<u>CPI, Price Index Reports.</u> Regional reports for both specific items and general (across the board) family budget items.	1944-1954	1.5

r.	<u>Housing Survey Reports.</u> 1964-1986 Survey findings regarding, how many units in a geographic area or state, how many owned/rented, # of rooms, age of structure, vacancy rate, etc.	6.0	
s.	<u>BLS Regional Reports.</u> 1964-1986 Regional reports pertaining to major topical concerns studies by BLS and arranged alphabetically by subject title.	6.0	
t.	<u>Employment and Wages Reports.</u>	1968-1975	3.0
u.	<u>Monthly Labor Reports.</u> 1957-1986	8.0	
v.	<u>PPI Detailed Reports.</u> 1967-1986	28.0	
w.	<u>Employment and Earnings (E&E) Report File.</u>	1973-1983	12.0
x.	<u>Area Wage Survey Report Files (AWS).</u> Reports cover selected cities within states or regions, ranging in date dependent on when last surveyed.	1966-1986	1.0
y.	<u>Current Wage Development Reports.</u>	1948-1981	8.0
z.	<u>Labor Development Abroad Reports.</u>	1947-1950	4.0
aa.	<u>Commodity Price Reports.</u> Special reports prepared by the War Industry Board on ways to help stabilize prices after World War I.	1919	1.0
bb.	<u>Employment/Unemployment (E&U) Reports.</u> Copies of published statistical reports concerning employment and unemployment figures for states and local areas.	1981-1983	1.0

Retention Period. Review annually and destroy material of no further reference value.

296. Publications, Distribution Copies Files. Extra copies of selected publications produced by the BLS office of publications for distribution upon request to the public, interested parties and other government agencies, files include the following BLS publications:

<u>Title of Publication</u>	<u>Inclusive Dates</u>	<u>Volume in Cubic Feet</u>
-----------------------------	------------------------	-----------------------------

<u>Title of Publication</u>	<u>Inclusive Dates</u>	<u>Volume in Cubic Feet</u>
a. Producers Price Index	1983-1987	35.0
b. Monthly Labor Review	1985-1987	30.0
c. New From BLS Quarterly Publication Listing	1986-1987	10.0
d. DOL News Releases	1985	2.0
e. Selected Monthly Labor Review Issues	1955-1975	2.0
f. Suppliment to Employment and Earnings Report	1982-1987	3.0
g. Employment and Earnings Report	1980-1987	12.0
h. CPI Detailed Reports	1981-1987	20.0
i. Current Wage Development Reports	1981-1987	10.0
j. Occupational Outlook Quarterly	1986-1987	1.0
k. Occupational Outlook Hard Book 2250 Series 1987	4.0	
l. BLS Bullentin Series	1973-1987	100.0
m. Area Wage Survey Series	1986-1987	14.0
n. BLS Report Series	1961-1986	27.0
o. BLS News Releases	1986-1987	9.0
p. Congressional Record Series	1987	4.0
q. Current (popular) Issuance Reference Materials including news releases, special reports, regional reports and AWS summaries.	1974-1987	142.0
r. Additional distribution copies of publications still in case lots.		100.0

Retention Period. Destroy when superseded, obsolete or no longer required for reference/distribution purposes.

297. Publications, Technical Reference News Release Files. Copies of published news releases 1942-Present.

Retention Period. Review annually and destroy material of no further reference value.

298. Publications, Technical Reference Bullentins File. Copies of bullentins, prepared by various BLS program offices, concerning a wide range of subjects to include: wages, collective bargaining, economic status reports, employment, productivity and labor force profiles, labor legislation and various other special studies for which record copies are maintained in the originating program offices.

Retention Period. Review annually and destroy material of no further reference value.

299. Publications, Technical Reference Speical Price Index Files. Copies of specially prepared price indexes which include the following:

- a. Spot Market Price Indexes 1961-1980
- b. Retail Fuel and Electricity Price Indexes 1935-1978

Retention Period. Review annually and destroy material of no further reference value.

300. Program Technical Reference Subject Files. Concerning employment, wages, productivity, specific occupation studies, income/education studies file consist of mainly BLS generated reports on these subjects from 1963 to 1982.

Retention Period. Review annually and destroy material of no further reference value.

301. Labor Issues Technical Reference Subject File. Files include articles, bullentins and reports covering wide range of labor issues to include; wages, collective bargaining, pension funds and reports to the President concerning labor disputes (Longshoreman; Railroad Workers, etc.). Files also include reports on Foreign Labor Developments, Labor Force Projectives and the impact of productivity and technology advancements on the labor force, from 1945-1981.

Retention Period. Review annually and destroy material of no further reference value.

302. Correspondence File. Contains requests for information by private Industry, Institions, etc.- and continuence letters from BLS to listed accounts.

Retention Period. Destroy when 1 year old or when no longer needed, which ever is sooner.

303. BLS Publication Reference File. Contains extra reference copies of BLS Bullentins, MLR, Reports, Article Reprints and other periodicals published from 1974-Present.

Retention Period. Destroy when superseded, obsolete or no longer needed for reference purposes.

304. Price, Wage and Production Chart Reference Files. Consisting of statistical chart books that catalog charts used in passed publications 1972-1979.

Retention Period. Destroy when superseded, obsolete or no longer needed for reference purposes.

305. CETA Program Reference Files.

Retention Period. Destroy when superseded, obsolete or no longer needed for reference purposes.

306. Employment and Wages Staff Working Papers File from 1975-1984. Destroy 6 months after final action or staff projects or 3 years after completion of final reports if no final action is taken.

307. Article Reprint/Report Subject References File. Microfiche images of selected article reprints and reports arranged by subject.

Retention Period. Destroy when superseded, obsolete or no longer needed for reference purposes.

308. International Labor Organization Directives. Directories from 1958-1963 used for reference.

Retention Period. Destroy when no longer needed for reference purposes.

ITEM 309: RESERVED.

310. Annual and Special Reports to the President by the Commissioner of Labor. Bond record copies of annual reports and special reports for Department of Labor operations, from 1888-1928. Special Reports cover such topics as "conditions of women and child wage earners", "workmans compensation Insurance in Europe (1909)", "Investigations of the telephone and telegraph companies (1909-1910)" and "Marriage and Divorce" (1889)".

Retention Period. Destroy when no longer needed for reference.

311. Monthly Labor Review. Bond record copies of the MLR from 1915 to present. Principle periodical published by BLS. Articles written by BLS program office personnel and outside authors are compiled, edited and published by the branch of Monthly Labor Review, Division of Editorial Services, Office of Publications (Office of Record).

Retention Period. Destroy when no longer needed for reference. (A copy of each MLR is to be included in the publications file (Item 275.1) for transfer to the National Archives.)

312. Finding Aids. Consisted of subject reference care file, inventory control card file and BLS publication listing microfiche file.

Retention Period. Follow disposition instructions for records to which they relate, or destroy when superseded/obsolete or no longer needed for reference.

DIVISION OF EDITORIAL SERVICES**a. Mission**

To publish periodicals, bulletins, reports, and other publications and related output that covers the economic and statistical research of the Bureau of Labor Statistics; to assure that coverage is comprehensive and of high quality; and to assure that output is accessible to the audiences for which it is intended.

b. Functions

- (1) To provide publications leadership in planning, editing and publishing the data and research of the Bureau; and monitoring publication standards; and
- (2) To provide administrative support to the Branch of the Monthly Labor Review and the Branch of Special Publications.

BRANCH OF MONTHLY LABOR REVIEW**a. Mission**

To publish a comprehensive and balanced journal that covers all aspects of Bureau and Department of Labor research, as well as related areas of economics, statistics, industrial relations, and the social sciences.

b. Functions

- (1) Publishes the Monthly Labor Review, the principal periodical issued by the Bureau. Keeps its professional and nonspecialist audience apprised of the full range of Bureau research, by major articles, research reports, summaries of bulletins and reports--and by articles from a variety of sources, bearing on the Bureau's and the Department's areas of interest. Carries a selection of current BLS statistics most likely to be useful to readers.
- (2) Assists program offices in planning the preparation and timing of articles reporting on Bureau research.
- (3) Evaluates all MLR manuscripts in terms of the particular subject matter, professional competency, objectivity, readability, consistency with previous articles on the subject: timeliness, quality and conformity with Bureau and Departmental policies; assists authors in the revision of articles.
- (4) Arranges for the preparation of articles by government, academic, and other authors to ensure well-rounded coverage of labor economics, industrial relations, and related economic and social issues; plans layout and production of each issue.
- (5) Conducts independent research to round out the Bureau's coverage

of economics, industrial relations, union affairs, etc., that are either outside the purview of other Bureau divisions or not in their current programs.

- (6) Prepares and monitors standards for material to be published in the MLR.

BRANCH OF SPECIAL PUBLICATIONS

a. Mission

To publish the definitive results of the Bureau's research programs, assuring that the economic and statistical content are of the highest quality and conform with the Bureau and Department of Labor policies.

b. Functions

- (1) Reviews, edits, and approves all BLS Public information bulletins, reports, and pamphlets. Responsible for monitoring publications from receipt of manuscript through delivery of printed copies.
- (2) Publishes several periodicals including CPI Detailed Report, Producer Price Indexes, and Employment and Earnings. Plans content and layout in cooperation with program offices. Edits manuscripts, establishes schedules, and approves final product.
- (3) Edits and publishes Occupational Outlook Quarterly.
- (4) Within the Division, prepares and publishes regularly several bulletins including the Handbook of Labor Statistics, Major BLS Programs, and BLS Handbook of Methods. Also initiates, prepares and publishes other reports and bulletins based on research and analysis that cut across several Bureau programs.
- (5) In cooperation with the program offices, formulates the BLS public information publications program for the fiscal year. Prepares publication proposals that satisfy Bureau and Departmental public information policies and control plans.
- (6) Evaluates requirements and determines press runs for free distribution and recommends GPO press runs for sale.
- (7) Coordinates the Bureau's publications control plan. Collects, analyzes and evaluates information on the Bureau's publishing program as required by the Department's Control System for Production of Periodicals, Pamphlets and Audiovisual Products and the Reform '88 Initiative. Represents the Bureau on the Department's Control System review Panel recommending clearance actions on publishing plans of other DOL agencies.
- (8) Establishes and monitors publications standards for Bureau bulletins, reports, pamphlets and selected periodicals.

313. Administrative Subject Files, Chief of Editorial Services. Administrative subject files to include, department directives, monthly reports, correspondence, etc.

Retention Period. Break files at least every 5 years and bring current materials forward to new files. Destroy when 5 years old or no longer needed for current business, which ever occurs first.

314. Monthly Labor Review Article Manuscript File. Includes originally submitted article manuscript, edited copies of article, editor evaluations/comments, correspondence and associated graphs and charts, filed chronologically by year.

Retention Period. Screen files annually, bring forward unpublished manuscripts still under consideration. Transfer manuscript files of published articles and inactive unpublished article manuscripts to the Washington National Records Center when 3 years old. WNRC will destroy 5 years after year in which file was received.

315. Monthly Labor Review Editorial Staff Reference Files. to include the following:

- a. Monthly Labor Review Reference File. Contains unbound individual issues to the MLR (2 each) with annual subject index listings, dating from 1953-present.
- b. Labor News Journal and Newsletter Reference File. File includes, copies of major union newspapers and newsletters such as the "Guild Reporter", "AFL-CIO News" and "News from the UAW".
- c. General/Business Newspaper and Business Periodical Reference File. includes copies of New York Times and the Wall Street Journal, Business Week and Other Business Periodicals.
- d. Daily Labor Report Reference File. Copies of Daily Labor Report, a Labor oriented news summary and analysis report published by Bureau of National Affairs Inc.
- e. Labor Acts Reference File. Contains Labor Employment congressional acts and legal opinions classified by subject for reference purposes.
- f. Monthly Labor Review Reference Library. Contains bond copies of Monthly Labor Review issues from 1915- present.

Retention Period. Destroy when superseded, obsolete or no longer needed for reference purposes.

316. MLR Article Subject Reference File. Computerized data base used to maintain MLR article subject Index. Index data elements include: author, title, book reviewers and subject. Example subject categories are: Employment, Labor Force, Technology, etc.

Retention Period. Delete when superseded, obsolete or no longer needed for reference purposes.

317. Weekly Manuscript Status Report File. Computerized based reporting system used to monitor progress of articles through the editing and approval processes.

Retention Period. Delete when superseded, obsolete or no longer needed for management purposes.

318. Special Publications Editorial Staff Reference Files. to include the following:

- a. BLS Bulletin Series Reference File. Contains bound copies of BLS Bulletins arranged by series number, beginning with 1st bulletin issued in 1886- Present.
- b. BLS Report Series Reference File. Contains bound copies of BLS Reports arranged by series numbers, beginning with 1st Report issued in 1886-Present.

Retention Period. Destroy when superseded, obsolete or no longer needed for reference purposes.

Note: Special publications serves as liason between the submitting offices and production services concerning production of BLS Bulletins and reports and provides editorial staff support for the publication of BLS Bulletins and Reports. The originating program office is the office of record for Bulletins and Reports produced by that office.

ORGANIZATION

BUREAU OF LABOR STATISTICS

OFFICE OF RESEARCH AND EVALUATION

a. Mission

To plan and direct activities for improving the quality of current statistical output and for long-term program development, by evaluating programs of the Bureau of Labor Statistics (with emphasis on conceptual, methodological, and technical issues, and on responsiveness to evolving user needs), by conducting research on economic, statistical and social issues relevant to the BLS mission, and by suggesting improvements to current BLS statistical and analytical output.

b. Functions

1.Reviews and evaluates Bureau programs with respect to concepts, statistical methodology, relevance, timeliness, reliability, cost effectiveness, and adherence to quality standards. Reviews evaluation studies conducted by program offices, outside consultants, independent commissions, and others, and coordinates Bureau response to them.

2.Develops or refines statistical and economic concepts and techniques for Bureau statistical programs, and sets standards for quality, relevance, and adequacy of statistical programs.

3.Participates in long-term planning for statistical programs, with particular attention to methods and techniques, and to adapting and developing data programs to meet evolving user needs.

4.Initiates, conducts, and coordinates research involving methodological and conceptual issues vital to BLS programs, or which cuts across subject matter areas.

5.Provides consultation and guidance to ensure the Bureau is using the most modern and effective statistical, econometric and quantitative methods and techniques.

6.Reviews proposed contracts for analytic, statistical, and consulting work emanating from BLS program offices to assure high technical standards and to coordinate and disseminate the results of such work across program lines. Reviews BLS contracts with other government agencies to assure conformity to BLS quality standards and appropriateness of work.

7.Serves as Bureau technical expert on research and evaluation activities, and on mathematical statistics, and represents the Bureau on these activities to other agencies, research institutions, and the general public.

8.Handles overall coordination between the BLS Business and Labor Advisory groups, as well as any other advisory groups, study commissions, or expert panels that may be established.

9.Lends analytic and technical expertise to other parts of the Department of Labor, whenever the special skills and expertise of the staff and unique within, or especially valuable to, the Department, for purposes of review of research, analytic or conceptual issues.

10.Serves as clearance officer for BLS and for DOL surveys.

OFFICE OF ECONOMIC RESEARCH

a. Mission

To develop, administer and participate in the conduct of a continuing economic research program which has the aim of providing sound and effective economic application for the Bureau's programs.

b. Functions

1. Reviews and evaluates new and existing economic theories and methodologies to determine appropriateness for Bureau applications. Evaluates methods presently in use with a view toward improving techniques and methods used in Bureau programs.

2. Provides consultation on econometric methods and techniques to Statistical Methods Divisions and other BLS organizational units.

3. Participates with other Bureau offices in designing projects which demonstrates new developments.

4. Initiates, conducts and coordinate economic research which will normally cut across subject matter areas or where particularly difficult technical, theoretical or conceptual issues exist.

5. As required, represents the Bureau in discussions with researchers in academic, government, and other research institutions and participates in interagency committees.

6. Participates with other Bureau offices in reviewing and evaluating operating programs, methods and procedures and provides advice and recommendations where appropriate.

OFFICE OF MATHEMATICAL STATISTICS

a. Mission

To plan and direct a continuing statistical research and evaluation program for the Bureau, by evaluating statistical aspects of programs, by conducting statistical research, and by suggesting improvements, with the aim of providing statistically sound and effective survey techniques for the Bureau's programs.

b. Functions

1. Reviews and evaluates statistical aspects of BLS programs for adequacy of statistical methodology and adherence to statistical standards with a view toward improving survey techniques and methods used in Bureau survey programs. Where appropriate, sets statistical standards.

2. Directs the statistical review for survey forms clearance for the Bureau. As requested by DOL, directs the review of DOL reporting forms and plans for statistical adequacy. As staff is available, provides technical assistance to other organizations in the Department for the design of statistical reporting plans.

3. Reviews and evaluates new methodologies to determine their appropriateness for BLS survey programs.

4. Initiates, conducts and coordinates statistical research which will normally, but not always, cut across subject matter areas. Research involves extending statistical knowledge by developing and/or adapting general statistical models and innovative survey techniques in order to improve the efficiency of sample survey practice and provide estimates for BLS statistical series that are fully consistent with the best statistical state-of-the-art with the evolving needs of uses of statistical series.

5. Provides continuing consultation, advice and guidance to professional staff in the Statistical Methods Divisions and to others in BLS on high-level technical problems in survey design, estimation and other statistical issues.

6. Represents the Bureau in statistical exchanges with researchers in academic, government, and other research institutions. Participates in interagency committees to set government-wide standards.

7. Provides statistical methods services for programs in BLS which do not have a Division of Statistical Methods.

OFFICE OF THE ASSOCIATE COMMISSIONER
OFFICE OF RESEARCH AND EVALUATION

319. Associate Commissioner's Program-Administrative Management Subject Files. This file contains records pertaining to the conduct of ongoing administrative/management responsibilities and activities carried on by the office of Research and Evaluation. Examples of subjects addressed by the records include: monthly program progress reports, meeting notes, quick response survey reports, OE manual drafts and various other program reports and working papers files also contain budget records, time and attendance and flex-time records.

Retention Period. Screen files to separate program subject files from general administrative subject files.

a. Program Management Subject Files - Permanent. Break files at least every five years and bring forward program records still pertinent to current operations. Transfer inactive program record to the Washington National Records Center when 5 years old. Offer for transfer to the Archives of the United States in 10 year blocks when the most recent record is 20 years old.

b. Administrative Management Subject Files - Break files at least every 5 years and bring current materials forward to new files. Destroy when 5 years old or no longer needed for current business, which ever occurs first, except:

1. Personnel Name Files. Destroy 1 year after separation or transfer of employee.

2. Time and Attendance Files. Destroy when 3 years old. (GRS 2/2h)

ITEM 319.1 Index to the Associate Commissioner's Correspondence File. A card file that cross-references subjects to decimal file designations and serves as a subject index to Item 319(a).

Retention Period. Permanent. Break and transfer concurrently with program files. An electrostatic copy may be provided in lieu of the original index.

320. Employment Recruiting File. Includes candidate resume, copies of papers authored by the candidate, correspondence and interview evaluations.

Retention Period. Review annually and destroy superseded or obsolete documents; or destroy all documents relating to an individual employee 1 year after separation or transfer. (GRS 1, 18a).

321. "Working Papers" Research and Reference File. Collection of papers, articles and reports published by other agencies, research institutions, universities and financial institutions on topics of material interest submitted to ORE as part of an informational exchange program.

Retention Period. Destroy when superseded, obsolete or no longer needed for reference purposes.

322. Proposal File. Comprised of grant proposal documents, correspondence and proposal evaluation reports.

Retention Period.

a. Unsuccessful (rejected or withdrawn) proposals. Destroy 3 years after rejection or withdrawal. (GRS 3/13)

b. Accepted proposals. Dispose of with related grant case file 3 years after date of grant completion, unless grant/contract performance is subject of review or enforcement action on such date (GRS3/ ~~13~~.5a)

323. "BLS Working Papers" Research and Reference File. Reference copies of published research reports on various subjects written by BLS program offices on topics of mutual interest and submitted to other research institutions.

Retention Period. Permanent. Break files at least every 5 years. Transfer to the WNRC when 10 years old. Transfer to the Archives of the United States in 10 year blocks when the most recent record is 20 years ~~old~~.

324. Progress Report Files. Contains monthly process reports issued by both them Office of Economic Research and the Office of Mathematical Statistics concerning the status of various projects underway at the time.

Retention Period. Review annually and destroy 1 year after the year in which the project is closed. (GRS 16, 7).

325. News Release Reference File. Contains reference copies of BLS news release, 1985 - date.

Retention Period. Destroy when superseded, obsolete or no longer needed for reference purposes.

326. ORE Chron. File. Contains file copies of in bound and out bound office correspondence, 1974 - date.

Retention Period. Destroy when 2 years old or no longer needed for reference purposes which every is later.

327. News Bulletin Reference File. Contains news bulletins and news letter issued by other outside research organizations.

Retention Period. Destroy when superseded, obsolete or no longer needed for reference purposes.

328. Reports and Correspondence Word Processing Files. Contains copies and drafts of ~~ORE~~ correspondence and reports retained on diskettes used in computer based word processing system, (textual final copies retained as a part of appropriate program or correspondence file.).

Retention Period. Delete when no longer needed for current business purposes.

OFFICE OF RESEARCH AND EVALUATION
OFFICE OF ECONOMIC RESEARCH

ITEM 329: Economic Research Program - Administrative Management Subject Files. This file contains administrative records such as travel, training, and time and attendance documents. Also included are reference copies of staff papers, memoranda and reports, manuscript drafts and comments, and agendas for and notes on committee meetings. Arranged chronologically.

Retention Period.

- a. Administrative Files. Break files at least every 5 years and bring current materials forward to new files. Destroy when 5 years old or no longer needed for current business, whichever occurs first, except:
- b. Personnel Name Files. Destroy 1 year after separation or transfer of employee.
- c. Time and Attendance Files. Destroy when 3 years old (GRS 2, Item 3(a)).

330. Office of Economic Research - Staff Economist and Reference Materials and Project Working Papers Files. The supervisory, professional and support employees maintain extra copies of printed materials, computer generated listing and reports, draft reports and articles, meeting notes and other working paper files covering their particular assignments.

Retention Period. Destroy when no longer needed for current business.

331. Article/Author Reference File. Collection of articles written by selected authors or economic topics.

Retention Period. Destroy when no longer needed for reference purposes.

332. National Longitudinal Survey Program Administrative Subject File. Long term special project to survey Labor Market experience, studying the following three special groups:

- a. Young Women
- b. Mature Women
- c. Youth

Files include such copies as: Progress reports, data collection reports, cost status reports, report coding and tabulation working papers and survey final reports. Files also include; program budget papers, invoices copies, and production reports.

Retention Period. Destroy 1 year after the year in which the project is closed. (GRS 16, 7).

ITEM 333: National Longitudinal Survey (NLS) Data Files. Data files for the surveys of older men, mature women, young men and young women collected as part of the ongoing NLS research project and provided to the public through The Ohio State University's Center for Human Resource Research. Data is collected biennially beginning in 1969.

Retention Period. Permanent. Transfer a copy of the data file, together with the documentation, to the National Archives when the data are made available to the public. Transfer copies of currently available files upon approval of this schedule.

ITEM 334: National Longitudinal Survey of Youth (NLSY) Data Files. Data files for a national longitudinal sample of young men and young women, ages 14 to 21, with an overrepresentation of blacks, Hispanics, and disadvantaged whites. An additional sample of young persons in the Armed Forces is also included in the NLSY. Data is collected annually.

a. Basic NLSY public use files for all samples:

Retention Period. Permanent. Transfer a copy of the data files, together with the documentation, to the National Archives when the data are made available to the public. Transfer copies of currently available files upon approval of this schedule.

b. NLSY Geographic Microdata Files (Geocode File) containing geographic - environmental data not available in the public use data tapes.

Retention Period. Permanent. Transfer a copy of the data files, together with the documentation, to the National Archives when the data are made available to the public. Transfer copies of currently available files upon approval of this schedule.

- c. NLSY Child Assessment Raw Item File and Merges Mother-Child Data File containing data not found in the basic NLSY files.

Retention Period. Permanent. Transfer a copy of the dat files, together with the documentation, to the National Archives when the data are made available to the public. Transfer copies of currently available files upon approval of this schedule.

- d. NLSY SAS and other special format data files.

Retention Period. Erase when no longer needed.

ITEM 335: NLS Documentation Electronic and Paper Files. NLS documentation including copies of the Survey Handbook, questionnaires and related materials, Keyword in Context files and data file documentation.

- a. NLS Survey Handbook.

Retention Period. Permanent. Transfer a copy of all available handbooks to the National Archives upon approval of this schedule. Transfer a copy of all handbooks when the dat tapes are transferred.

- b. Questionnaires and related documentation of the NLS available only in paper form.

Retention Period. Permanent. Transfer one copy of each available questionnaire and related records to the National Archives upon approval of this schedule. Transfer a copy of all future questionnaires and documentation when the data tapes are transferred.

- c. Data file documentation and Keyword in Context files.

- 1. Electronic file:

Retention Period. Permanent. Transfer a copy of all available data file documentation and Keyword in Context files to the National Archives upon approval of this schedule. Transfer a copy of all future files when the data tapes are transferred.

- 2. Paper copies:

Retention Period. Destroy when no longer needed for reference.

REWRITE ITEM 336 & FOLLOWS:

ITEM 336. Business Research Advisory Council Meeting Files. This file contains record copies of minutes of the BRAC Governing Board and committees. The latter are established by subject - economic growth, employment, etc. Also included are committee correspondence, lists of attendees, and transcripts of BRAC conferences. The earliest records date to the early 1970s.

Retention Period. Permanent. Break files at least every 5 years. Transfer to the WNRC when 10 years old. Transfer to the National Archives in 10-year blocks when the most recent record is 20 years old.

ITEM 337. BRAC Membership and Program Files. This item includes membership lists (1967-82) and biographical files on council and committee members, including a separate file for inactive, retired, or deceased members; documents on advisory committee establishment (PL 92-463); BRAC annual reports; program files; and files on one-time miscellaneous meetings.

Retention Period.

- a. Council Program and Report Files. Permanent. Break files at least every 5 years. Transfer to the WNRC when 10 years old. Offer to the Archives of the United States in 10 year blocks when the most recent record is 20 years old.
- b. Council Membership Files. Permanent. Break files at least every 5 years. Transfer to the WNRC when 10 years old. Offer to the Archives of the United States in 10 year blocks when the most recent record is 20 years old.
- c. BRAC General Administrative Files. Break files annually. Destroy when 2 years old or when no longer needed, whichever is sooner.

338. Business Research Advisory Council Administration Chron. File. Contains file copies of BRAC correspondence.

Retention Period. Destroy when no longer needed for reference purposes.

339. Business Research Advisory Council Subject Files. Includes copies of incoming and outgoing correspondence concerning BRAC topics under discussion, telephone notes, copies of meeting minutes and membership directories. Also contains copies of reference materials relating to BRAC interests and working papers on BRAC reports on BLS programs.

Retention Period. Destroy when 5 years old or no longer needed for current business.

OFFICE OF RESEARCH AND EVALUATION
OFFICE OF MATHEMATICAL STATISTICS

340. Mathematical Statistics Program - Administrative Management Subject Files. This files contains records pertaining to the conduct of ongoing administrative/management responsibilities and activities carried on by the Office of Mathematical Statistics under the direction of the Assistant Commissioner Office of Research and Evaluation (Mathematical Statistics). Examples of subjects addressed by the records include: Program Planning Reports, Research Working Papers Data Collection task force project notes and reports, OSD statistics "note series" files and fellowship program files. Files includes Davis Bacon Act reference materials and other subject reference materials. Files also contains administrative subjects such as, OMS Chron. files Employee contracts, Personnel Action reports, EEO guidelines, Job Performance Standards and position descriptions, Recruitment records, Time and Attendance records and Requisition files.

Retention Period. Screen files to separate program subject files from general administrative subject files.

a. Program Management Subject Files - Permanent. Break files at least every five year and bring forward program records still pertinent to current operations. Transfer inactive program records to the Washington National Records Center when 5 years old. Offer for transfer to the Archives of the United States in 10 year blocks when the most recent record is 20 years old.

b. Administrative Management Subject Files - break files at least every 5 years and bring current materials forward to new files. Destroy when 5 years old or no longer needed for current business, which ever occurs first, except:

1. Personnel Name Files. Destroy 1 year after separation or transfer of employee.

2. Time and Attendance Files. Destroy when 3 years old. (GRS 2/3a)

341. Office of Mathematical Statistics - Mathematics Staff Reference Materials and Project Working Papers File. The supervisory, professional and materials, computers generated listings and reports, draft reports and articles, meeting notes and other working papers files covering their particular assignments.

Retention Period. Destroy when no longer needed for current business.

EXCERPT FROM NATIONAL ARCHIVES AND
RECORDS ADMINISTRATION (NARA) GENERAL RECORDS
SCHEDULE 20 COVERING PROCESSING
(INTERMEDIATE) MACHINE-READABLE AND RELATED RECORDS

Page 23

The following records disposition authorities cover processing or intermediate machine-readable and related files and were issued in General Records Schedule 20 of NARA. They relate to such files as work files, test files, input source files, intermediate input/output files, valid transaction files, and the like that have not been specifically listed in this Schedule as separate items in the segments covering machine-readable records.

These disposition authorities of General Records Schedule 20 *L23* have been referred to in several items of this Schedule.

GENERAL RECORDS SCHEDULE 20

Electronic Records

This schedule provides disposal authorization for certain electronic records and specified hard-copy (paper) or microform records that are integrally related to the electronic records.

This schedule applies to disposable electronic records routinely stored on magnetic media by Federal agencies in central data processing facilities, including ones operated for agencies by contractors. It covers records created by computer operators, programmers, analysts, and systems administrators in order to store and maintain computer files in such facilities; certain master files, including some that are components of data base management systems; and certain files created from master files for specific purposes. Items covering disposable electronic records produced by end users in office automation applications (e.g., word processing files, certain text files, and data bases developed on personal computers in support of administrative functions) are included in General Records Schedule 23, Records Common to Most Offices Within Agencies. GRS 20 and 23 do not cover all electronic records. Electronic records not covered by items in GRS 20 or GRS 23 may not be destroyed unless authorized by a Standard Form 115 that has been approved by the National Archives and Records Administration (NARA).

The records covered by several of the items in this schedule are authorized for erasure or deletion when no longer needed. NARA could not establish a more definite retention that would be appropriate in all applications. The agency should, when appropriate, determine a more specific disposition instruction, such as "Delete after X update cycles" or "Delete when X years old," for inclusion in its records disposition directives or manual. NARA approval is not needed to set retention periods for records authorized for destruction when no longer needed by the GRS.

Items 2a and 1a (in part) of this schedule apply to hard-copy or microform records used in conjunction with electronic files. Item 1 also covers printouts produced to test, use, and maintain master files. Items 10 and 11 of this schedule should be applied to special purpose programs and documentation for disposable electronic records regardless of the medium in which such documentation and programs exist.

ITEM

<u>NO.</u>	<u>DESCRIPTION OF RECORDS</u>	<u>AUTHORIZED DISPOSITION</u>
1.	<u>Files/Records Created in Central ADP Facilities to Create, Use, and Maintain Master Files.</u>	
a.	Electronic files or records created solely to test system performance, as well as hard-copy printouts and related documentation for the electronic files/records.	Delete/destroy when no longer needed.
b.	Electronic files or records used to create or update a master file, including, but not limited to, work files, valid transaction files, and intermediate input/output records.	Delete after information has been transferred to the master file and verified.
c.	Electronic files and hard-copy printouts created to monitor system usage, including, but not limited to, log-in files, password files, audit trail files, system usage files, and cost-back files used to assess charges for system use.	Delete/destroy when no longer needed in accordance with sound business practice and agency standard operating procedures.
2.	<u>Input/Source Records.</u>	
a.	Non-electronic documents or forms designed and used solely to create, update, or modify the records in an electronic medium and not required for audit or legal purposes (such as need for signatures) and not previously scheduled for permanent retention in a NARA-approved agency records schedule.	Destroy after the information has been converted to an electronic medium and verified, or when no longer needed to support the reconstruction of, or serve as the backup to, the master file, whichever is later.
b.	Electronic records, except as noted in item 2c, entered into the system during an update process, and not required for audit and legal purposes.	Delete when data have been entered into the master file or data base and verified, or when no longer required to support reconstruction of, or serve as back-up to, a master file or data base, whichever is later.

ITEM

NO. DESCRIPTION OF RECORDS

AUTHORIZED DISPOSITION

c. Electronic records received from another agency and used as input/source records by the receiving agency, EXCLUDING records produced by another agency under the terms of an interagency agreement, or records created by another agency in response to the specific information needs of the receiving agency.

Delete when data have been entered into the master file or data base and verified, or when no longer needed to support reconstruction of, or serve as back up to, the master file or data base, whichever is later.

d. Computer files or records containing uncalibrated and unvalidated digital or analog data collected during observation or measurement activities or research and development programs and used as input for a digital master file or data base.

Delete after the necessary data have been incorporated into a master file.

3. Master Files, (Including Master Files that are Components of Data Base Management Systems) Relating to Administrative Functions.

Master files that:

- a) replace, in whole or in part, administrative records scheduled for disposal under one or more items in GRS 1-16, 18, 22, or 23; and
- b) consist only of the same information as is contained in all or portions of the disposable records it replaces or duplicates;

EXCLUDING those that replace or duplicate the following GRS items: GRS 1, items 1, 21, 22, 25f; GRS 2, item 17; GRS 12, item 3; and GRS 18, item 5.

Delete after the expiration of the retention period authorized for the disposable hard copy file or when no longer needed, whichever is later.

ITEM

NO. DESCRIPTION OF RECORDS

AUTHORIZED DISPOSITION

6. Print File.

Electronic file extracted from a master file or data base without changing it and used solely to produce hard-copy publications and/or printouts of tabulations, ledgers, registers, and reports.

Delete when no longer needed.

7. Technical Reformat File.

Electronic file consisting of data copied from a master file or data base for the specific purpose of information interchange and written with varying technical specifications, EXCLUDING files created for transfer to the National Archives.

Delete when no longer needed.

8. Security Backup File.

Electronic file consisting of data identical in physical format to a master file or data base and retained in case the master file or data base is damaged or inadvertently erased.

a. File identical to records scheduled for transfer to the National Archives.

Delete when the identical records have been transferred to the National Archives and successfully copied, or when replaced by a subsequent security backup file.

b. File identical to records authorized for disposal in a NARA-approved records schedule.

Delete when the identical records have been deleted, or when replaced by a subsequent security backup file.

ITEM

NO. DESCRIPTION OF RECORDS

AUTHORIZED DISPOSITION

9. Finding Aids (or indexes).

Electronic indexes, lists, registers, and other finding aids used only to provide access to records authorized for destruction by the GRS or a NARA approved SF 115, EXCLUDING records containing abstracts or other information that can be used as an information source apart from the related records.

Delete with related records or when no longer needed, whichever is later.

10. Special Purpose Programs.

Application software necessary solely to use or maintain a master file or data base authorized for disposal in a GRS item or a NARA-approved records schedule, EXCLUDING special purpose software necessary to use or maintain any unscheduled master file or data base or any master file or data base scheduled for transfer to the National Archives.

Delete when related master file or data base has been deleted.

11. Documentation.

Data systems specifications, file specifications, codebooks, record layouts, user guides, output specifications, and final reports (regardless of medium) relating to a master file or data base that has been authorized for disposal in a NARA-approved records schedule, EXCLUDING documentation relating to any unscheduled master file or data base or relating to any master file or data base scheduled for transfer to the National Archives.

Destroy or delete when superseded or obsolete, or upon authorized destruction of related master file or data base.

[NOTE: See item 1a of this schedule for documentation relating to system testing.]

GENERAL RECORDS SCHEDULE 23

Records Common to Most Offices Within Agencies

This schedule provides for the disposal of certain records common to most offices in Federal agencies. It covers administrative subject files; facilitative records such as suspense files, tracking and control records, calendars, and indexes; and transitory documents; as well as certain types of records created in electronic form on stand-alone or networked micro-and mini-computers.

Office Administrative Files described under item 1 are records retained by an originating office as its record of initiation of an action, request, or response to requests for information. This item may be applied only to separate administrative files containing such records as copies of documents submitted to other offices for action including budget feeder documents, purchase orders, training requests. Item 1 may not be applied to files that also contain program records, and it may not be applied by an office that receives and takes action on documents submitted by other offices.

ITEM

<u>NO.</u>	<u>DESCRIPTION OF RECORDS</u>	<u>AUTHORIZED DISPOSITION</u>
1.	<u>Office Administrative Files.</u> Records accumulated by individual offices that relate to the internal administration or housekeeping activities of the office rather than the functions for which the office exists. In general, these records relate to the office organization, staffing, procedures, and communications; the expenditure of funds, including budget records; day-to-day administration of office personnel including training and travel; supplies and office services and equipment requests and receipts; and the use of office space and utilities. They may also include copies of internal activity and workload reports (including work progress, statistical, and narrative reports prepared in the office and forwarded to higher levels) and other materials that do not serve as unique documentation of the programs of the office.	Destroy when 2 years old, or when no longer needed, whichever is sooner.

[NOTE: This schedule is not applicable to the record copies of organizational charts, functional statements, and related records that document the essential organization, staffing, and procedures of the office, which must be scheduled prior to disposition by submitting an SF 115 to NARA.]

ITEM

NO. DESCRIPTION OF RECORDS

AUTHORIZED DISPOSITION

2. Word Processing Files.

Documents such as letters, messages, memoranda, reports, handbooks, directives, and manuals recorded on electronic media such as hard disks or floppy diskettes:

- | | |
|--|--|
| a. When used to produce hard copy which is maintained in organized files. | Delete when no longer needed to create a hard copy. |
| b. When maintained only in electronic form, and duplicate the information in and take the place of records that would otherwise be maintained in hard copy providing that the hard copy has been authorized for destruction by the GRS or a NARA-approved SF 115. | Delete after the expiration of the retention period authorized for the hard copy by the GRS or a NARA-approved SF 115. |

3. Administrative Data Bases.

Data bases that support administrative or housekeeping functions, containing information derived from hard copy records authorized for destruction by the GRS or a NARA-approved SF 115, if the hard copy records are maintained in organized files, and hard-copy printouts from these data bases created for short-term administrative purposes.

Delete information in the data base when no longer needed.

4. Electronic Spreadsheets.

Spreadsheets that are recorded on electronic media such as hard disks or floppy diskettes:

- | | |
|--|--|
| a. When used to produce hard copy which is maintained in organized files. | Delete when no longer needed to update or produce hard copy. |
|--|--|

ITEM

NO. DESCRIPTION OF RECORDS

AUTHORIZED DISPOSITION

b. When maintained only in electronic form.

Delete after the expiration of the retention period authorized for the hard copy by the GRS or a NARA-approved SF 115. If the electronic version replaces hard copy records with differing retention periods, and agency software does not readily permit selective deletion, delete after the longest retention period has expired.

5. Schedules of Daily Activities.

Calendars, appointment books, schedules, logs, diaries, and other records documenting meetings, appointments, telephone calls, trips, visits, and other activities by Federal employees while serving in an official capacity, created and maintained in hard copy or electronic form, EXCLUDING materials determined to be personal.

a. Records containing substantive information relating to official activities, the substance of which has not been incorporated into official files, EXCLUDING records relating to the official activities of high government officials (see note).

Destroy or delete when 2 years old.

[NOTE: High level officials include the heads of departments and independent agencies, their deputies and assistants; the heads of program offices and staff offices including assistant secretaries, administrators, and commissioners; directors of offices, bureaus, or equivalent; principal regional officials; staff assistants to those aforementioned officials, such as special assistants, confidential assistants, and administrative assistants; and career Federal employees, political appointees, and officers of the Armed Forces serving in equivalent or comparable positions. Unique substantive records relating to the activities of these individuals must be scheduled by submission of an SF 115 to NARA.]

b. Records documenting routine activities containing no substantive information and records containing substantive information, the substance of which has been incorporated into organized files.

Destroy or delete when no longer needed.

ITEM

NO. DESCRIPTION OF RECORDS

AUTHORIZED DISPOSITION

6. Suspense Files.

Documents arranged in chronological order as a reminder that an action is required on a given date or that a reply to action is expected and, if not received, should be traced on a given date.

a. A note or other reminder to take action.

Destroy after action is taken.

b. The file copy or an extra copy of an outgoing communication, filed by the date on which a reply is expected.

Withdraw documents when reply is received. (1) If suspense copy is an extra copy, destroy immediately. (2) If suspense copy is the file copy, incorporate it into the official files.

7. Transitory Files.

Documents of short-term interest which have no documentary or evidential value and normally need not be kept more than 90 days. Examples of transitory correspondence are shown below.

Destroy when 3 months old, or when no longer needed, whichever is sooner.

a. Routine requests for information or publications and copies of replies which require no administrative action, no policy decision, and no special compilation or research for reply.

b. Originating office copies of letters of transmittal that do not add any information to that contained in the transmitted material, and receiving office copy if filed separately from transmitted material.

c. Quasi-official notices including memoranda and other records that do not serve as the basis of official actions, such as notices of holidays or charity and welfare fund appeals, bond campaigns, and similar records.

ITEM

NO. DESCRIPTION OF RECORDS

AUTHORIZED DISPOSITION

8. Tracking and Control Records.

Logs, registers, and other records in hard copy or electronic form used to control or document the status of correspondence, reports, or other records that are authorized for destruction by the GRS or a NARA-approved SF 115.

Destroy when no longer needed.

9. Finding Aids (or indexes).

Indexes, lists, registers, and other finding aids in hard copy or electronic form used only to provide access to records authorized for destruction by the GRS or a NARA-approved SF 115, EXCLUDING records containing abstracts or other information that can be used as an information source apart from the related records.

Destroy or delete with the related records or sooner if no longer needed.

BUREAU OF LABOR STATISTICS
PROPOSED SCHEDULE

Listing of Permanent Records Proposed For
Transfer to the National Archives of the
United States

Immediate Office of the Commissioner

- Item 1. Commissioner's General Office Files.
Arranged alphabetically by subject or by
organizational unit concerned. 1978-date
Volume: 64 cubic feet Accretion: 7 cubic feet per
year
- Item 2A(i) Commissioner's Personal File (official segment).
Arranged alphabetically by subject or title.
1963-date
Volume: 18 cubic feet Accretion: 2 cubic feet per
year
- Item 3 BLS Office and Divisional Monthly Progress Reports and Occasional
Overviews.
Arranged chronologically 1978-date
Volume: 3 cubic feet Accretion: ½ cubic foot per
year
- ~~Item 5 Special File on Commissioner's Congressional Testimony, including
Joint Economics Committee Testimony.
Arranged chronologically 1980-date
Volume: 5 cubic feet Accretion: 1 cubic foot per
year~~
- Item 6 Special File on Improvement Efforts Involving Local Area
Unemployment Statistics.
Arranged alphabetically 1976-1978
by Subject
Volume: 1 cubic foot Accretion: Closed
- Item 7 Selected Inactive Commissioner's Documents Reflecting on Bureau
History, Functions, Organization, and Policy Matters.
In no special order. 1922-1985 with gaps
Volume: 3 cubic feet Accretion: Closed

- Item 34a OFO Administrative Management Subject File.
 Arranged alphabetically by subject 1971-date with gaps
 Volume: 2 cubic feet Accretion: Negligible
- Item 43b. Regional Office Periodic Report Files.
 Arranged by date 1978 to date
 Volume: 2 cubic feet Accretion: 1 cubic foot per year
- Item 44a BLS File on participation in the North American Conference on Labor Statistics.
 Arranged by date 1949-1958, 1974-1981
 Volume: 1 cubic foot Accretion: Closed

OFFICE OF PRODUCTIVITY AND TECHNOLOGY
DIVISION OF INTERNATIONAL TRAINING

- Item 85a Record Copy of BLS International Training Newsletter Files.
 Arranged by date 1981-date
 Volume: Negligible Accretion: Negligible
- Item 86a Record copy of International Training Program Catalogs and Other Announcements.
 Arranged by date 1978-date
 Volume: 1 cubic foot Accretion: Negligible

OFFICE OF ADMINISTRATION DIVISION
OF PERSONNEL AND ORGANIZATION MANAGEMENT

- ~~Item 137. Upward Mobility Program Files.
 Arranged by Subject Classification 1979 - date
 Volume: 3 cubic feet Accretion: Less than 1 cubic foot per year~~

OFFICE OF ADMINISTRATION
DIVISION OF FINANCIAL PLANNING AND
MANAGEMENT OVERVIEW OF DIVISION MISSION
FUNCTIONS, AND ORGANIZATION.

- ~~Item 158. OSHA -- State Files.
 Arranged by Region and State 1980-1986
 Volume: 9 cubic feet Accretion: None~~

Item 163~~6~~ Formulation Files, Budget Policy File Section
and Budget Estimates and Justification File Section.
Arranged by Fiscal Year 1978 - date
Volume: 13 cubic feet Accretion: 1 cubic feet per year
Office of Technology and Operations Review

~~Item 232. Budget and Financial File, Budget Policy File Section and Budget
Estimates and Justification File Section.
Arranged by Budgetary Subject File Title 1985 - date
Volume: 5 cubic feet Accretion: Less than 1 cubic foot
per year~~

OFFICE OF TECHNOLOGY AND OPERATIONS REVIEW
DIVISION OF COMMUNICATIONS AND COMPUTER TECHNOLOGY

~~Item 247b. Division Wide Computer documentation working files, documentation
record copies.
Arranged by Subject 1982 - date
Volume: 36 cubic feet Accretion: Less than 10 cubic feet per
year~~

OFFICE OF TECHNOLOGY AND OPERATIONS REVIEW
DIVISION OF MANAGEMENT INFORMATION SYSTEMS

~~Item 260b. Division wide computer documentation working files, documentation record copies.
 Arranged by Subject 1980 - date
 Volume: 30 cubic feet Accretion: Less than 8 cubic feet per year~~

~~Item 262a. MIS System Documentation File, Documentation Package Section.
 Arranged by Subject 1982 - date
 Volume: 22 cubic feet Accretion: 10 cubic feet per year~~

OFFICE OF PUBLICATIONS
OFFICE OF THE CHIEF (ASSOCIATE COMMISSIONER)

~~Item 263a. Program Management Subject Files.
 Arranged by Subject Classification 1973 - date
 Volume: 50 cubic feet Accretion: Approx. 3-4 cubic feet per year~~

Item 268^a Labor Research Advisory Council Meeting Minutes
 Arranged Chronologically by Meeting Date 1949 - date
 Volume: 4 cubic feet Accretion: Less than 1 cubic foot per year

~~Item 269. Labor Research Advisory Council Committee Project Files.
 Arranged by Subject Classification 1956 - date
 Volume: 5 cubic feet Accretion: Less than 1 cubic foot per year~~

Item 270. Labor Research Advisory Council Membership Files.
 Arranged Alphabetically by name 1982 - date
 Volume: 2 cubic feet Accretion: Less than 1 cubic foot per year

Item 271a. Labor Research Advisory Council/BLS Administrative Subject Files, Council Report Files.
 Arranged by Subject 1960 - 1984
 Volume: 2 cubic feet Accretion: None

OFFICE OF PUBLICATIONS
DIVISION OF INFORMATION SERVICES

Item 278a. News Release Record Copy files.
Arranged chronologically by subject 1940 - date
Volume: 2 cubic feet Accretion: Less than 1 cubic foot per year

OFFICE OF PUBLICATIONS
DIVISION OF PRODUCTION SERVICES
INQUIRIES AND CORRESPONDENCE SECTION

~~Item 309. Interstate Conference on Labor Statistics Proceedings File
Arranged chronologically by meeting date 1964 - 1978
Volume: 2 cubic feet Accretion: None~~

~~Item 310. Annual and Special Reports to the President by the Commissioner of Labor
Arranged chronologically 1888 - 1928
Volume: 14 cubic feet Accretion: None~~

OFFICE OF PUBLICATIONS DIVISION
OF EDITORIAL SERVICES BRANCH OF
MONTHLY LABOR REVIEW

~~Item 311. Monthly Labor Review (Bond Copies)
Arranged Chronologically 1915 - date
Volume: 22 cubic feet Accretion: Less than 1 cubic foot per year~~

OFFICE OF RESEARCH AND EVALUATION
OFFICE OF THE ASSOCIATE COMMISSIONER

Item 319a. Program Management Subject Files
Arranged by Subject 1972 - date
Volume: 30 cubic feet Accretion: 2 cubic feet per year

OFFICE OF RESEARCH AND EVALUATION
OFFICE OF ECONOMIC RESEARCH

~~Item 329a. Program Management Subject Files
Arranged by Subject 1972 - date
Volume: 10 cubic feet Accretion: Less than 2 cubic feet per
year~~

Item 333. National Longitudinal Survey Handbook File
(publication record copies)
Arranged: Chronologically 1986 - date
Volume: Less than 1 cubic feet Accretion: Less than 1 cubic feet per
year

Item 334^{a,b,c} NLS keyword and Numeric Code Documentation Files
Arranged Chronologically by update 1966 - 1972
to program
Volume: 2 cubic feet Accretion: None

Item 336. Business Research Advisory Council Meeting Minutes
Arranged Chronologically 1947 - date
Volume: 5 cubic feet Accretion: Less than 1 cubic foot per
year

Item 337^{a,b} Business Research Advisory Council Subject Files, Council Report
Files Section.
Arranged by Subject 1967 - date
Volume: 4 cubic feet Accretion: Less than 1 cubic foot per
year

OFFICE OF RESEARCH AND EVALUATION
OFFICE OF MATHEMATICAL STATISTICS

Item 340a. Program Management Subject Files.
Arranged by Subject 1975 - date
Volume: 8 cubic feet Accretion: Less than 1 cubic foot per
year

BUREAU OF LABOR STATISTICS
PROPOSED SCHEDULE

Cross Reference to the Disposition Authorities
of this Proposed Schedule to the Existing
October 1, 1971 Schedule NN170-100

IMMEDIATE OFFICE OF THE COMMISSIONER

The proposed schedule authorizes disposition of Commissioner's office records under Items 1 through 18.

Item 1-a of old Schedule NN170-100 appears to be superseded by Item 1 of the proposed schedule.

Item 8 of old Schedule NN170-100 appears to be superseded by Item 1 and Item 5 of the proposed schedule.

OFFICE OF THE COMMISSIONER
Management Information Staff

The proposed schedule authorizes disposition of Management Information Staff records under Items 19 through 30.

While Item 9 of Old Schedule NN170-100, Bureau Project Control Records, could partially apply to Item 20 of the proposed schedule, old Schedule Item 9 also applies to other Bureau Offices in addition to MIS Staff. It is not completely superseded by this proposed Schedule.

OFFICE OF FIELD OPERATIONS
Office of the Associate Commissioner

The proposed Schedule authorizes the disposition of the OFO Associate Commissioner's Office records under Items 31 through 57.

Item 1-b of the Old Schedule, NN170-100, could partially apply to Items 31-34 of the proposed Schedule, but Item 1-b, of the old Schedule also applies to other offices of the BLS. It is not completely superseded by this proposed Schedule.

Item 6 of the old Schedule, Progress and Activity Reports, could partially apply to Item 43 of the proposed Schedule, but Item 6 of the old Schedule could apply to other BLS offices as well. It is not completely superseded by this proposed Schedule item.

Also Item 92 of the old Schedule, NN170-100, Forms Management Files, could apply to Items 51-55 of the proposed schedule. As such, item 92 could be considered to be superseded by these proposed Schedule Items.

Branch of Program Related Training

The proposed Schedule authorizes the disposition of Branch of Program Related Training, OFO, records under Items 58 through 74.

Only Item 17 of the old Schedule, NN170-100, Field Agents Training Files, could apply to Items 64 through 70 of the proposed Schedule. As such item 17 of the old Schedule would be considered to be superseded by these proposed Schedule Items.

OFFICE OF PRODUCTIVITY AND TECHNOLOGY
Division of International Training

The proposed Schedule authorizes the disposition of Division of International Training, OPT records under Items 75 through 99.

No Items of old Schedule NN170-100 appear to be superseded by the disposal authorizations of the proposed Schedule.

OFFICE OF SURVEY PROCESSING
Office of the Assistant Commissioner

The proposed Schedule authorizes the disposition of Assistant Commissioner Office, OSP, under Items 100-102.

No items of old Schedule NN170-100 appear to be completely superseded by the disposal authorizations of the proposed Schedule.

OFFICE OF ADMINISTRATION

The proposed schedule authorizes the disposition of the Office of Administration records holdings, to include all of its divisions under items 103-225.

Items 11 and 84 - 98 of old schedule NN170 - 100 are superseded by the disposal authorizations of the proposed schedule.

OFFICE OF TECHNOLOGY AND OPERATIONS REVIEW (OTOR)

The proposal schedule authorizes the disposition of OTOR records holdings under items 226-262 and supersedes any matching records schedules established as a part of the old schedule NN170-100.

OFFICE OF PUBLICATIONS

The proposed schedule authorizes the disposition of the Office of Publications records, to include all of its divisions under items 263 - 318.

Items 5, 7, 12 and 13 and any other matching records schedules established as a part of old schedule NN170-100 are superseded by the proposed schedule.

OFFICE OF RESEARCH AND EVALUATION (ORE)

The proposed schedule authorizes the disposition of ORE records under items 319-341 and supersedes any matching records schedules established as a part of the old schedule NN170-100.